

Investigation of a GDI injector with an innovative flowmeter for high-pressure transient flows

Original

Investigation of a GDI injector with an innovative flowmeter for high-pressure transient flows / Ferrari, Alessandro; Pizzo, Pietro; Vento, Oscar. - In: INTERNATIONAL JOURNAL OF ENGINE RESEARCH. - ISSN 1468-0874. - 24:9(2023), pp. 4287-4296. [10.1177/14680874231187552]

Availability:

This version is available at: 11583/2980688 since: 2023-07-26T08:03:30Z

Publisher:

SAGE

Published

DOI:10.1177/14680874231187552

Terms of use:

This article is made available under terms and conditions as specified in the corresponding bibliographic description in the repository

Publisher copyright

Sage postprint/Author's Accepted Manuscript

Ferrari, Alessandro; Pizzo, Pietro; Vento, Oscar, Investigation of a GDI injector with an innovative flowmeter for high-pressure transient flows, accepted for publication in INTERNATIONAL JOURNAL OF ENGINE RESEARCH (24 9) pp. 4287-4296. © 2023 (Copyright Holder). DOI:10.1177/14680874231187552

(Article begins on next page)

1 **Investigation of a GDI injector with an innovative flowmeter for high-pressure transient flows**

2 Alessandro Ferrari¹, Pietro Pizzo² and Oscar Vento^{1,*}

3 ¹ Energy Department, Politecnico di Torino, Corso Duca degli Abruzzi 24, 10129, Torino, Italy

4 ² Rabotti Srl, Via Gino Capponi 13, 10148, Torino, Italy

5 * Corresponding author. E-mail address: oscar.vento@polito.it

6 **Abstract**

7 A new flowmeter for high pressure flows, characterized by intense dynamic events, is presented. The
8 flowmeter algorithm is based on the measurement of two pressure signals along the investigated pipe, and the
9 flowrate is obtained through an ordinary differential equation that is obtained from the combination of the
10 continuity and the momentum partial differential equations. This flowmeter has been applied to a GDI injector
11 to monitor the flowrate that enters the injector during an injection event. A 1D numerical model of the GDI
12 injector has been set up and validated, and the numerical outcomes have been used to confirm the consistency
13 of the experimental results obtained from the new flowmeter, for both single and pilot-main injections. The
14 internal dynamics of the injector has also been investigated, using both the 1D numerical tool and the
15 innovative flowmeter. A possible feedback-control strategy has been set up to compensate for any inaccuracy
16 of the injected mass by applying the flowmeter to the hydraulic high-pressure circuit.

17 **Keywords**

18 GDI injector; instantaneous flowrate measurement; high-pressure flow; innovative flowmeter; closed-loop
19 control.

20 **1. Introduction**

21 The prediction of an instantaneous high-pressure flowrate in fluid power hydraulic circuits can only be
22 obtained by developing numerical models in which all the main hydraulic, mechanical, and electromagnetic
23 characteristics are taken into account. However, an extensive validation against experimental transients is
24 required to guarantee an adequate accuracy of these models [1]. Such an approach suffers from the absence of
25 a flowmeter featuring the following characteristics: reduced dimensions and non-invasiveness, an excellent
26 dynamic response, and the ability to work under high-pressure levels.

27 Various technologies and operating principles have been developed for flowrate measurements. Turbine
28 flowmeters are used to measure the frequency generated by the rotation of a rotor, which is directly
29 proportional to the flowrate [2]. These steadily calibrated devices can be applied to measure unsteady flowrates
30 [3], but only pulsating [4], [5] or intermittent [6] ones with a lower frequency than 1 kHz can be considered.

31 Orifice flowmeters are widely diffused in industry, due to their simplicity in terms of construction and
32 installation [7], [8]; however, they are generally employed for steady-state flows [9] and particular correction
33 curves have to be employed to modify the steady equation for pulsating flows [10].

34 Electromagnetic flowmeters are suitable for flows characterized by a pronounced frequency content, but the
35 constraint on the required electrical conductivity of the measured fluid, which should be lower than 0.1 uS/cm,
36 excludes the possibility of applying this category of flowmeters to diesel or gasoline engines, since both are
37 characterized by a much lower conductivity than that of the aforementioned threshold [11].

38 The currently available Coriolis flowmeters can be applied for the measurement of a flowrate characterized by
39 a pressure of up to around 400 bar [12], although modern diesel injection systems can reach pressure levels of
40 up to 3000 bar [13], while the 500 bar level is the target for next-generation GDI systems [14]. However, the
41 invasiveness of this family of devices may represent a limit to their application [15].

42 In this context, a flowrate estimation, based on the measurement of instantaneous pressure traces, represents a
43 very attractive opportunity, due to the characteristics of the pressure sensors, in terms of miniaturization and
44 dynamic response [16]. If the layout of the hydraulic system ensures that the pressure wave propagation occurs
45 along a single direction, a mathematical relation between the measured pressure time history and that of the
46 flowrate can be established for each pipe section [17]. However, if the pressure waves travel back and forth
47 along the pipe, as in the rail-to-injector pipe of a Common Rail system [18], one pressure signal is not enough
48 for the evaluation of the time distribution a consistent flowrate.

49 In the present investigation, an instantaneous high-pressure flowrate has been determined by measuring two
50 pressure traces through the use of piezoresistive transducers. A first-order nonlinear ordinary differential
51 equation has been obtained by combining Euler's mass conservation and momentum balance equations, where
52 both the steady-state and the unsteady friction terms have been considered. The presented flowmeter, which
53 has already been satisfactorily applied to Common Rail systems [19] (with pressures of up to 1800 bar) and to

54 volumetric pumps [20, 21] (with pressures in the 4-140 bar range), has here been applied to a GDI system,
55 with the support of the 1D diagnostic tool, to investigate its internal fluid dynamics . Furthermore, a possible
56 closed-loop control strategy of the injected mass, which is based on the application of the presented flowmeter
57 to the fuel injection hydraulic circuit, is presented.

58 2. Experimental facilities

59 Tests were performed in the research laboratory at the Rabotti headquarter. The hydraulic test bench is a
60 Rabotti TEC201 Evolution. It is composed of a conventional fuel injection system test stand featuring an
61 electric motor, the speed of which can be controlled over the 0-4000 rpm range, a thermal regulation system
62 of the tank and a low-pressure feeding circuit, which allows the high-pressure pump to be filled with
63 pressurized oil over the 0-40 bar range. A typical Common Rail module is installed on this bench. This module
64 contains the high-pressure pump, the rail, and some measurement devices (pressure and temperature sensors,
65 Coriolis flowmeter, Injection Analyzer). The driving signals to the injector and to the rail/pump pressure
66 control devices, i.e. the pressure control valve (PCV) and the fuel metering valve (FMV), are generated by an
67 in-house developed control unit that offers the possibility of freely managing the injection pressure, the number
68 of injections, the energizing time of each shot (ET), the dwell time between each shot (DT), the injection
69 frequency and the configuration of the injector current profile (voltage, current levels and duration of each
70 phase of the driving command).

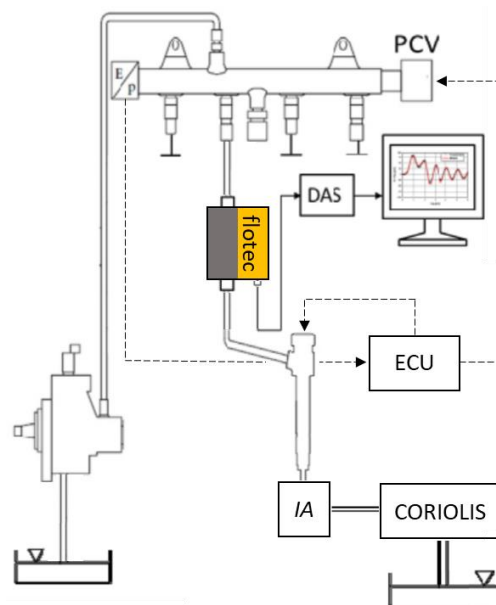

71

72

Fig. 1 – Layout of the experimental apparatus.

73 Furthermore, it can be used in either manual mode, by introducing the test operative conditions and recording
74 the test results manually, or automatically, using a pre-recorded test plan.

75 A scheme of the experimental layout is shown in Fig. 1. A high-pressure rotary pump feeds the rail to which
76 the injector is connected, through an 840 mm long pipe, with an internal diameter, d , of 2 mm. This pipe is
77 equipped with the new high-pressure flowmeter, which has been called “Flotec”. The flowmeter, represented
78 as a colored box in Fig. 1 and in the photos in Fig. 2, is constituted by a piece of pipe onto which two
79 piezoresistive pressure sensors are mounted at a distance $l=200$ mm from each other. The upstream pressure
80 sensor, p_{up} , is 320 mm far from the rail, while the pressure sensors p_{dw} is 200 mm far from p_{up} (and closer to
81 the injector). This portion of pipe is installed between the rail and the tested injector, as shown in Fig. 2a,
82 where the two pressure sensors constituting the flowmeter can be seen, while, in Fig. 2b, the flowmeter is
83 presented with its external shell.

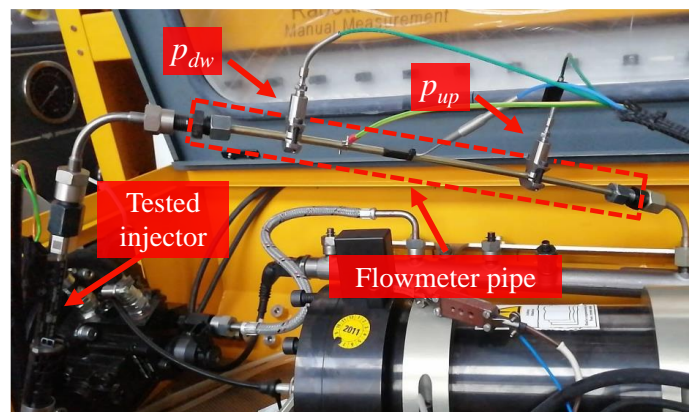

84
85 (a) The flowmeter pipe equipped with the two pressure sensors.



86
87 (b) The flowmeter with its external shell.

88 Fig. 2 - Pictures of the Flotec flowmeter installed in the GDI injection system.

90 The employed piezoresistive transducers present an accuracy of ± 1.25 bar. Because of the difficulty of
91 measuring the flow temperature (in order to evaluate the flow properties, such as density and dynamic
92 viscosity), a thermocouple (accuracy ± 2 °C), which is directly linked to the fluid temperature, is used to
93 measure the temperature of the external surface of the pipe between the two pressure sensors, and the flow
94 temperature is thus obtained with a simple sub-model. The portion of the pipe in which the thermocouple is
95 placed has been insulated in order to quickly reach a steady-state measurement, as the operative condition of
96 the system is modified. The injected flowrate is measured by the Injection Analyzer, that is, a Bosch method-
97 based flowmeter (labelled “IA” in Fig. 1, with an accuracy of $< \pm 0.1$ mg/shot), in which the pressure signal is
98 measured downstream of the injector tip and the injected fuel travels along a 11 m long pipe to prevent pressure
99 wave reflections that could disturb the ongoing injection event; a Coriolis flowmeter, placed downstream of
100 this pipe, measures the average flowrate ($\leq \pm 0.1\%$ accuracy of the measured flowrate).

101 The GDI injector, a scheme of which is shown in Fig. 3, is normally closed, because the spring preload and
102 the fuel pressure create a closure force. When the current signal acts on the injector, a magnetic force, generated
103 at the solenoid, pushes the needle up until it reaches its stroke-end (the injector is not ballistic), thus making
104 the injection start. As soon as the current signal is switched off, the magnetic force becomes null, the needle
105 reaches the end of its downstroke and the nozzle closes, and this determines the end of the injection. Because
106 of the absence of a pilot stage, the GDI injector can be assimilated to a fast two-way electro-valve with an inlet
107 and one outlet port.

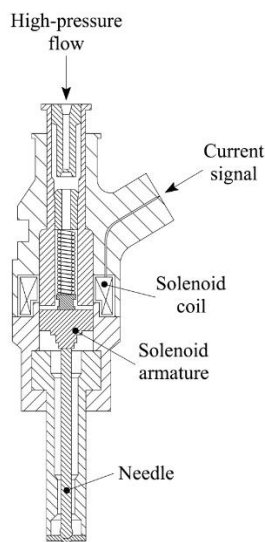

108

109

Fig. 3 – Scheme of the GDI Injector.

110 3. Flowmeter algorithm

111 The one-dimensional form of the partial differential equations of the continuity and momentum balance of a
112 slender pipe can be written as [22]:

$$113 \quad \begin{cases} \frac{d\rho}{dt} + \rho \frac{\partial u}{\partial x} = 0 \\ \frac{\partial u}{\partial t} + u \frac{\partial u}{\partial x} + \frac{1}{\rho} \frac{\partial p}{\partial x} = -\frac{4\tau_w}{\rho d} \end{cases} \quad (1)$$

114 where u , p , and ρ indicate the fluid velocity, fluid pressure, and fluid density averaged over the pipe cross-
115 section area, respectively; x stands for the spatial coordinate oriented along the axis of the pipe, t is the time,
116 and τ_w is the wall shear stress. The one-dimensional assumption is justified by the fact that the aspect ratio of
117 the considered pipe portion is equal to $l/d= 100$, where l stands for the length of the pipe-portion between the
118 Flotec pressure sensor locations. Furthermore, the accuracy of the unidimensional approach has been proved
119 in previous research where 3D model results have been compared for some Flotec applications [20, 21].

120 It is assumed, through the hypothesis of a local incompressible fluid for the piece of pipeline between the two
121 pressure transducers, that $\frac{d\rho}{dt} \approx 0$. Hence, the liquid density variations due to the change in the mean pressure
122 level are considered, while the density fluctuations due to the pressure oscillations around the time-averaged
123 pressure level are neglected. The consistency of this hypothesis can be verified when the Mach number, defined
124 as the ratio of the flow velocity to the speed of sound velocity, is lower than 0.1 [23]. Since the speed of sound
125 under the isothermal assumption is higher than 1000 m/s for gasoline, diesel oil, and mineral oils, the
126 abovementioned condition is satisfied for a large number of fluid power applications, if cavitation is not
127 experienced. Therefore, the continuity equation reduces to $\frac{\partial u}{\partial x} = 0$, and the momentum balance equation
128 becomes

$$129 \quad \frac{\partial u}{\partial t} + \frac{1}{\rho} \frac{\partial p}{\partial x} = -\frac{4\tau_w}{\rho d} \quad (2)$$

130 If Eq. 2 is multiplied by $\rho A/l$, where A represent the pipe cross-section area, by integrating over the distance l ,
131 one obtains:

132
$$\frac{d\bar{G}}{dt} = \frac{A}{l} \Delta p - \pi d \bar{\tau}_w \quad (3)$$

133 where G represents the mass flowrate and $\Delta p = p_{up} - p_{dw}$. The overlined quantities refer to the space-
 134 averaged quantities along length l . By performing an integration of Eq. (3) with respect to time, one obtains
 135 the space averaged flow-rate time history:

136
$$\bar{G}(t) = \bar{G}_0 + \int_0^t \frac{A}{l} \Delta p dt - \pi d \int_0^t \bar{\tau}_w dt \quad (4)$$

137 where \bar{G}_0 represents the initial value of $\bar{G}(t)$, which is usually unknown. By conducting further analytical
 138 steps, detailed in [19], it is possible to rewrite Eq. 4 as

139
$$\bar{G}(t) = \langle G \rangle + \frac{A}{l} \int_0^t [\Delta p - \langle \Delta p \rangle] dt - \pi d \Delta \bar{\Gamma}_{faf} \quad (5)$$

140 where the angular brackets indicate time-averaged quantities and $\Delta \bar{\Gamma}_{faf}$ is a function that depends on the
 141 unsteady friction [19]. As can be inferred from Eq. (5), the instantaneous mass flowrate can be determined by
 142 measuring the time-average flowrate $\langle G \rangle$ (e.g., by means of a Coriolis flowmeter) and the pressure difference,
 143 Δp , along the considered pipe.

144 **4. Injector numerical model**

145 A 1D numerical model of the injector has been developed together with its feeding pipe and validated using
 146 numerous experimental data for both single and pilot-main injections, over a range of nominal rail pressure
 147 levels (p_{nom}) from 80 bar to 150 bar. This numerical diagnostic tool considers the main characteristics of the
 148 high-pressure hydraulic circuit, the electromagnetic driving circuit and the mechanical components. Figure 4
 149 shows a schematic of the injector numerical model. Generally, the circuit is constituted by OD chambers linked
 150 together by means of 1D pipes [24]. The Flotec pressure signal closest to the rail (p_{up}), as well as the current
 151 (I) and the voltage (V) signals to the solenoid were selected as boundary conditions. By selecting this set of
 152 boundary conditions, it was possible to avoid any inaccuracy in the modelling of the rail, the pump, and the
 153 ECU [25]. The fluid is assumed as isothermal, and the energy equation therefore reduces to a state equation,
 154 and the pipe model implements the generalized Euler partial differential equations, which are solved by means
 155 of a Lax-Wendroff numerical method. The moving elements are governed by the ordinary differential form of

156 Newton's law, according to a mass-spring-damper approach. The forces involved in the numerical model can
 157 be ascribed to hydraulic, mechanical, and electromagnetic phenomena. In particular, the electromagnetic force,
 158 F_E , acting on the needle was evaluated as [1]:

$$159 \quad F_E = -\frac{1}{2} \Phi^2 \frac{d\mathfrak{R}}{dx} \quad (6)$$

160 where $\frac{d\mathfrak{R}}{dx}$ represents the variation in the circuit reluctance, namely \mathfrak{R} , with respect to the needle lift, and Φ is
 161 the magnetic flux, which can be determined as:

$$162 \quad \Phi = \frac{1}{S} \int_0^t [V(t) - RI(t)] dt \quad (7)$$

163 Quantities V and I stand for the voltage and current that are applied to the injector solenoid, while R and S
 164 represent the measured resistance and the number of solenoid windings, respectively. During the needle
 165 movement, a viscous force is generated between the armature and the injector body, due to the presence of a
 166 thin boundary layer. The flow in this small annular passage is laminar and follows Poiseuille's law. The viscous
 167 friction force on the armature can therefore be evaluated as:

$$168 \quad F_{vis} = \frac{\mu \cdot L_c \cdot v \cdot \pi \cdot d_a}{\delta_r} \quad (8)$$

169 where d_a is the armature diameter, L_c is the length of the annular passage, δ_r is the radial distance between the
 170 armature and the injector holder, μ is the flow dynamic viscosity, and v is the velocity of the needle.

171 The main geometrical features of the GDI injector, implemented in the numerical model, are reported in Table
 172 1.

173 *Table 1 - Main geometrical features of the tested injector.*

Property	Value
Number of holes [-]	6
Nozzle hole diameter [mm]	0.22
Needle length [mm]	30.9
Needle ball diameter [mm]	2.7
Armature diameter (d_a) [mm]	10
Annular passage length (L_c) [mm]	4.45
Armature radial distance (δ_r) [mm]	0.12

174

175

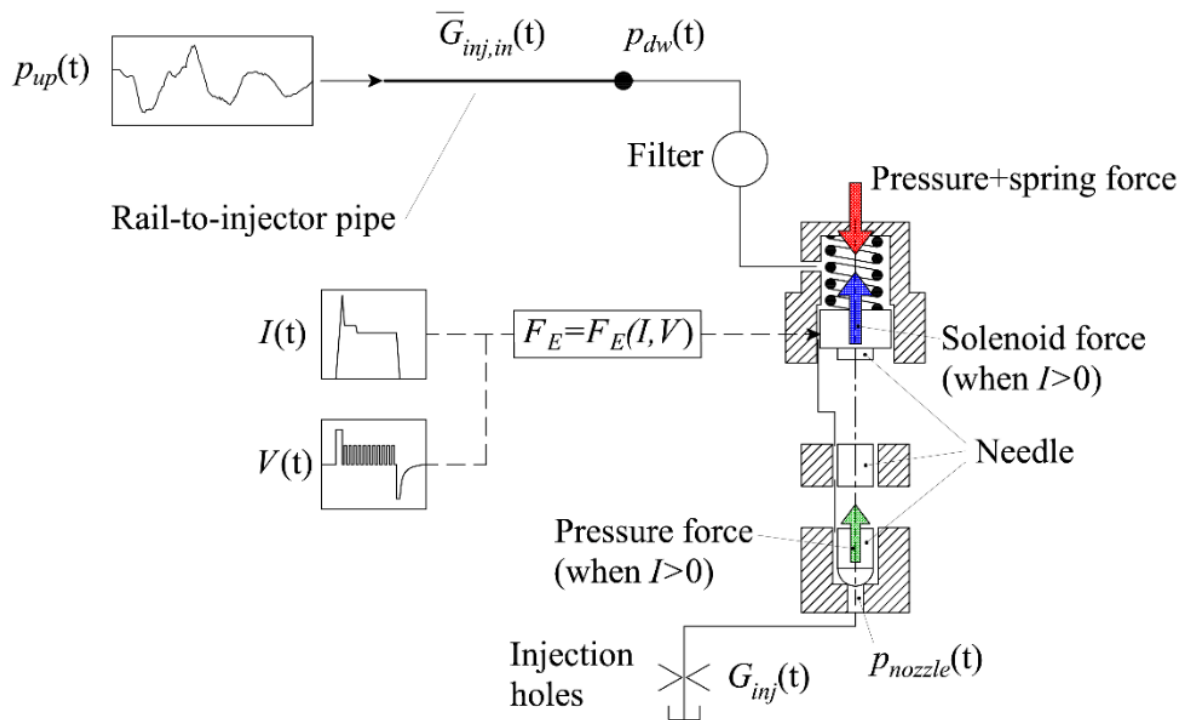

Fig. 4 - Scheme of the numerical model of the GDI injector.

177

178

179

180 The model validation involved a comparison of the numerical injected flowrate (G_{inj}) and of the numerical
 181 pressure time history (p_{dw}) with the corresponding experimental traces, for both single and pilot-main
 182 injections.

183 Furthermore, the numerical injector characteristic curves for different rail pressure levels over the previously
 184 mentioned range were determined and compared with the experimental ones.

185 Figures 5 and 6 show the comparisons of the p_{dw} and G_{inj} time histories for a single and a pilot-main injection,
 186 respectively: the symbols identify the experimental traces, while the lines refer to the numerical outcomes. As
 187 can be inferred, the numerical results match the experimental ones perfectly, for both cases. This satisfactory
 188 performance of the numerical model was verified over several $p_{nom} - ET$ working points for single injections,
 189 and for several $p_{nom} - DT - ET_{main} - ET_{pil}$ sets for pilot-main injections.

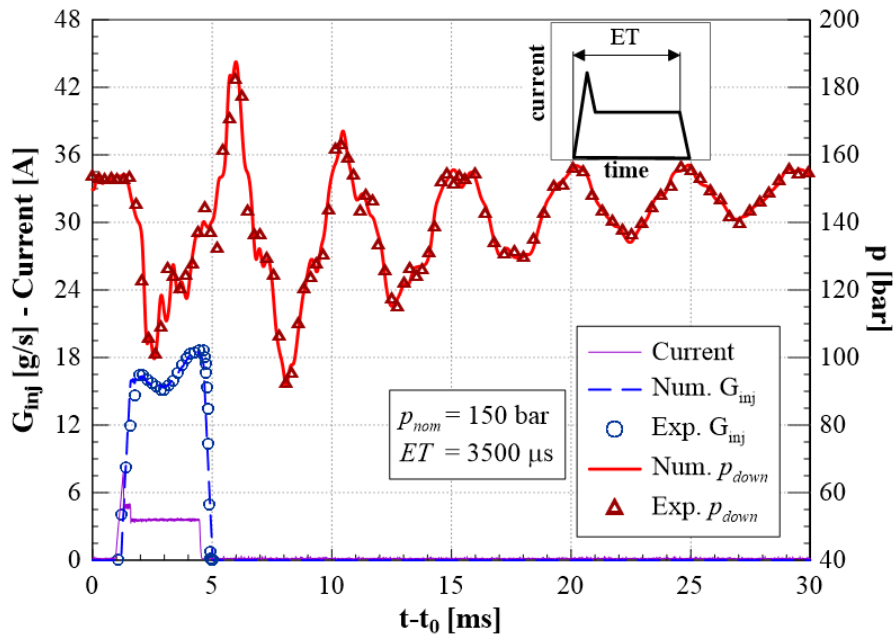

190

191

Fig. 5 - Comparison of the numerical and the experimental results for a single injection.

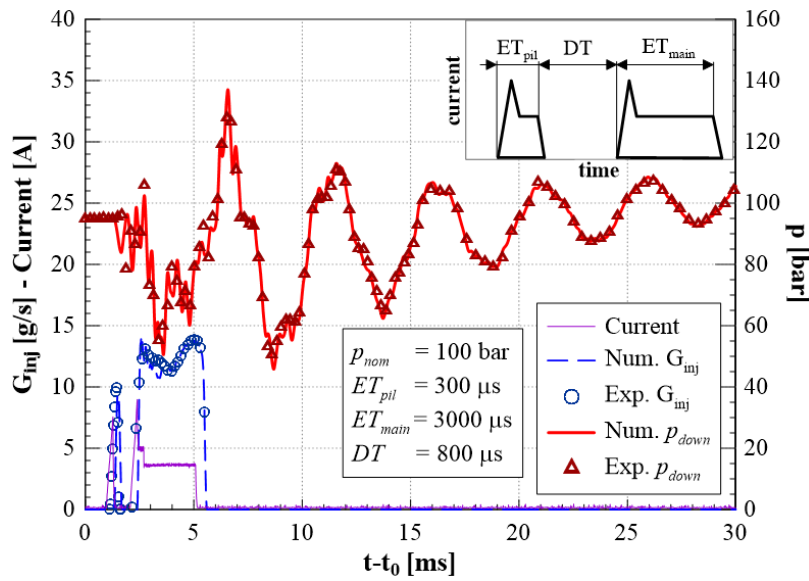

192

193

Fig. 6 - Comparison of the numerical and the experimental results for a pilot-main injection.

194

195 The comparison between the numerical and experimental injector characteristics is reported in Fig. 7 for
 196 different p_{nom} levels (80 bar, 100 bar, 120 bar and 150 bar). The agreement between the numerical and the
 197 experimental results is satisfactory, since the maximum error between the experimental injected mass and the
 198 numerical one (such a difference includes the experimental inaccuracy) is less than 1.7 mg, a result that further
 199 validates the model.

200

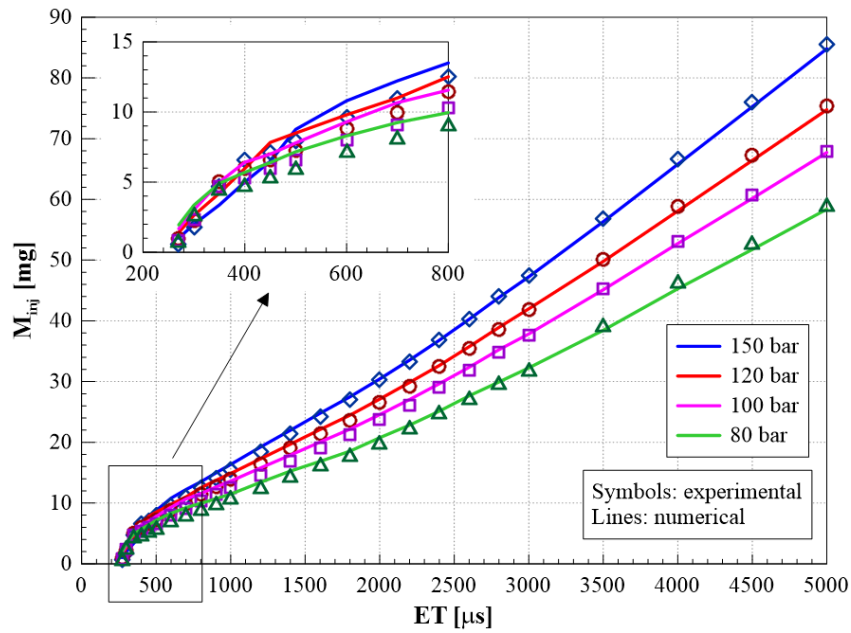

Fig. 7 – Numerical and experimental injector characteristics.

5. Experimental and numerical results

The numerical flowrate through the injector feeding pipe was determined from the 1D diagnostic tool (cf. Fig. 4). This numerical flowrate was compared with the experimental one measured with the flowmeter, and the results of this comparison are reported in Figs. 8 (single injection) and 9 (pilot-main injection): symbols are used to represent the numerical results and solid lines are utilized for the flowmeter data. As can be inferred from Figs. 8 and 9, the measured flowrates agree with those of the numerical diagnostic tool, and this further validates the new flowmeter. Since the compressibility of the flow is taken into account in the 1D numerical model, the good agreement shown in Figs. 8 and 9 demonstrates the consistency of the incompressible flow assumptions considered for the determination of the flowmeter.

From Fig. 7, it can be seen that the slope of the injector characteristic changes with respect to ET . The injected mass sharply increases with ET over the $270 \mu s \div 550 \mu s$ ET range. Figure 10 reports the normalized needle lifts (N/N_{max}) obtained using the numerical tool, the experimental injected flowrates, and the numerical pressure trace inside the nozzle (p_{nozzle} , cf. Fig. 4), for different ET values at $p_{nom} = 150$ bar. As can be seen in Fig. 10, when $ET = 350 \mu s$ or $ET = 450 \mu s$, the injected flowrate is controlled by the needle seat area (the needle does not reach the end of its upper stroke over the considered ET range). When the needle reaches the end of its upper stroke ($ET \approx 550 \mu s$), the injected flowrate presents a local maximum and is controlled by the pressure drop

219 through the nozzle holes (cf. $ET= 600 \mu\text{s}$ and $ET= 1200 \mu\text{s}$ in Fig. 10). This explains the sharp augment in the
 220 injected mass over the $270 \mu\text{s} \div 550 \mu\text{s}$ ET range.

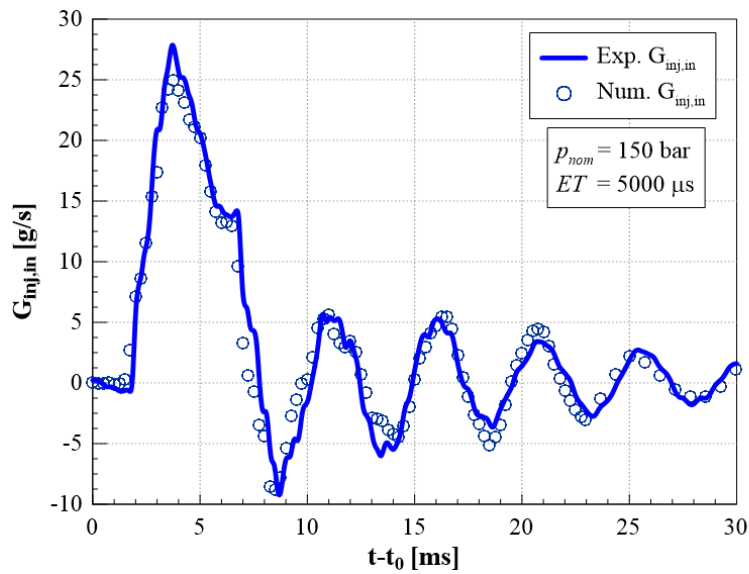

221

222

Fig. 8 - Comparison of the numerical and the measured injector-inlet flowrates for a single injection.

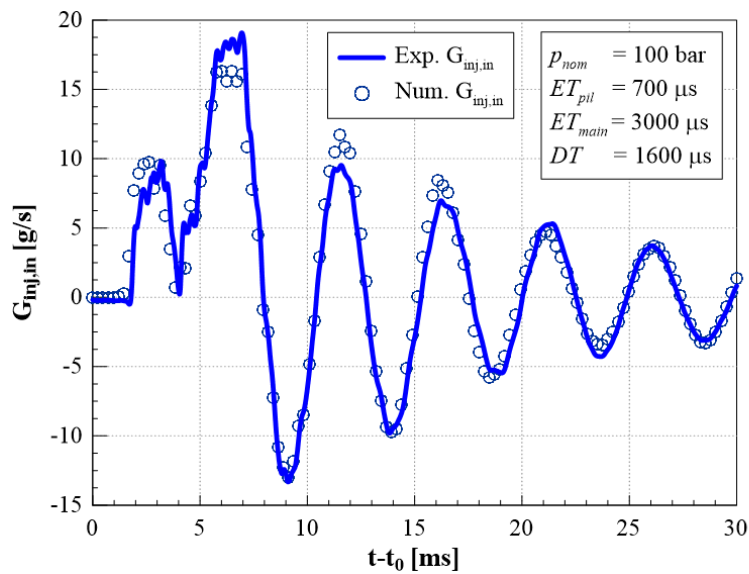

223

224

225

Fig. 9 - Comparison of the numerical and the measured injector-inlet flowrates for a pilot-main injection.

226 Furthermore, the $ET-M_{inj}$ characteristic slope increases more when $ET > 2200 \mu\text{s}$ than over the
 227 $ET= 550 \mu\text{s} \div 2200 \mu\text{s}$ range, for all the considered rail pressure levels (cf. Fig. 7). This phenomenon can be
 228 explained by considering the measured flowrate entering the injector and by analysing the propagation of the
 229 pressure waves throughout the high-pressure circuit of the fuel injection system [26].

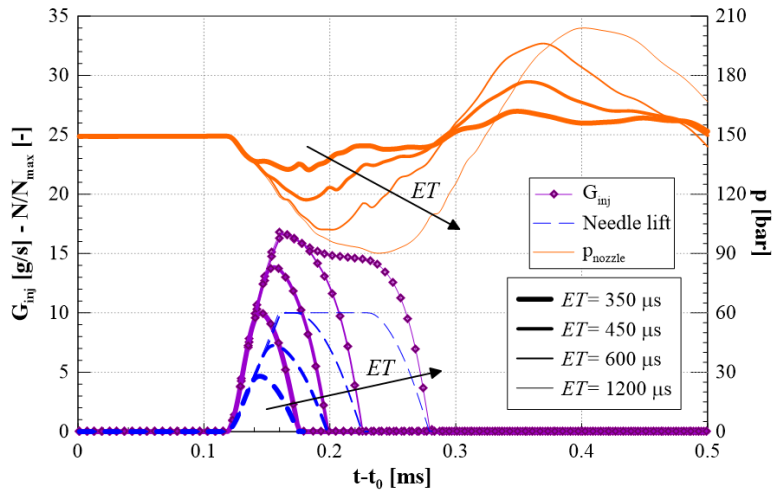

230

231

Fig. 10 - Needle lift, injected flowrate and nozzle pressure for different ETs.

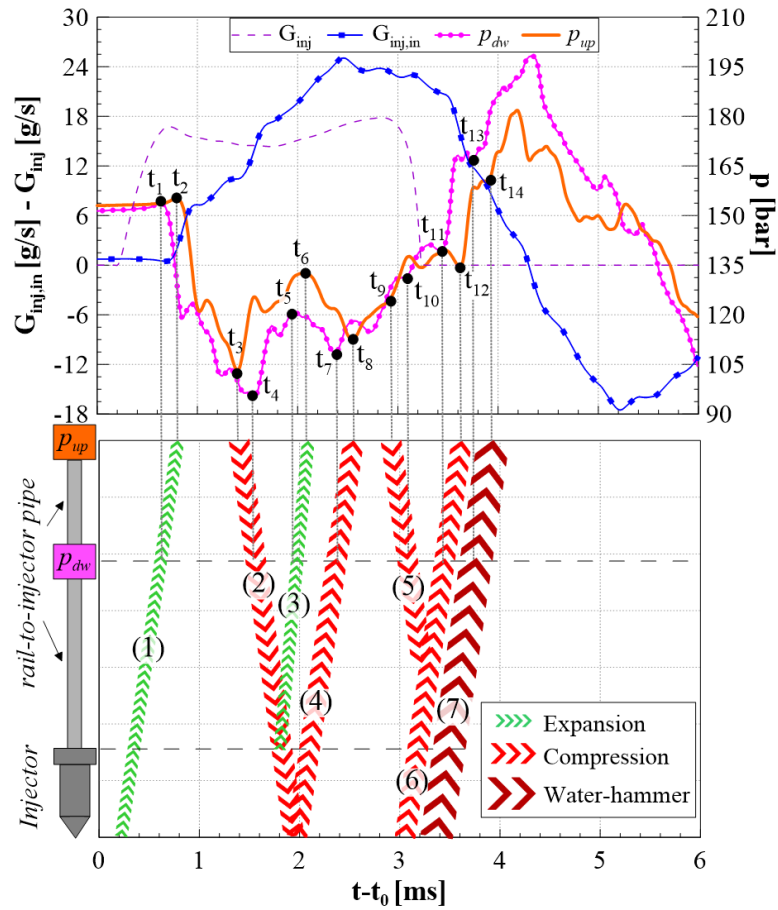

232

233

Fig. 11 – Propagation of the pressure waves in the hydraulic circuit ($p_{nom} = 150 \text{ bar}$, $ET = 2800 \mu\text{s}$).

234

The upper part of Fig. 11 reports the measured flowrate at the injector inlet, the p_{up} and p_{dw} pressure signals,

235

and the measured injected flowrate for an injection schedule of $p_{nom} = 150 \text{ bar}$ and $ET = 2800 \mu\text{s}$, while a

236

schematic representation of the propagation of the pressure waves through the hydraulic circuit is presented in

237

the lower part, where the circuit is represented in scale on the left of the bottom graph and the vertical axis

238 reports a spatial coordinate. When the needle opens the nozzle and the injected flowrate start to rise, an
239 expansion wave (1), which is the first wave experienced by the hydraulic system, travels from the injector to
240 the rail and, consequently, a pressure drop can be observed in p_{dw} (at $t=t_1$) and, after a certain delay, in p_{up} (at
241 $t=t_2$). Thus, from these time instants, the first expansion wave travelling from the injector tip to the rail can be
242 represented, as shown in the bottom graph of Fig. 11, between the spatial locations referring to p_{up} and p_{dw} .
243 When this wave reaches the rail, it is reflected as a compression wave (2); the pressure rise in p_{up} ($t=t_3$) occurs
244 in advance, with respect to that in p_{dw} ($t=t_4$), and this indicates that the pressure wave is travelling from the rail
245 toward the injector. Such a compression can be extended up to the nozzle. Another reflection occurs in this
246 hydraulic circuit when a wave reflected by the rail enters the injector, due to the difference in the diameter
247 between the injector feeding pipe and the injector entrance. The presence of a pressure drop that first occurs
248 in p_{dw} ($t=t_5$) and then in p_{up} ($t=t_6$) justifies the presence of a partial reflection, as an expansion wave (3) of the
249 compression wave (2) that is entering the injector. Wave (3) can be represented in the graph when the t_5 and t_6
250 time instants are known. When the compression wave (2) reaches the injector tip, it is reflected as a
251 compression wave (4), which travels toward the rail, as the occurrence of the pressure rise first in p_{dw} ($t=t_7$)
252 and then in p_{up} ($t=t_8$) confirms. In the meanwhile, the expansion wave (3) has reached the rail and has been
253 reflected as a compression wave (5) that travels toward the injector, thus implying a further pressure rise in p_{up}
254 ($t=t_9$) and then in p_{dw} ($t=t_{10}$). Prior to the reflection of this wave (5) at the injector entrance, the injected flowrate
255 decreases as the needle starts its downward stroke and, when the entering flowrate exceeds the injected one, a
256 compression wave (6) leaves the needle seat area and propagates upstream, thus leading to a pressure rise that
257 is detected first in p_{dw} ($t=t_{11}$) and then in p_{up} ($t=t_{12}$). In a similar way to the first expansion wave (1), by
258 identifying the time instants t_{11} and t_{12} , which refer to a compression wave moving from p_{dw} to p_{up} , and by
259 extending this wave backward till it reaches the injector tip, it can be confirmed that it starts during the
260 descending phase of G_{inj} , i.e., when the needle is moving downward. Finally, as the needle reaches the end of
261 its downstroke (the injected flowrate is null), a water-hammer (7) is triggered in the nozzle and this drives an
262 impulsive pressure rise in p_{dw} ($t=t_{13}$) and then in p_{up} ($t=t_{14}$). For conciseness reasons, the expansion wave given
263 by the reflection of the compression wave (4) in the rail has been omitted from the figure (the time instants at
264 which p_{up} and, subsequently, p_{dw} start to decrease can easily be identified between t_{10} and t_{11}). It can be noted,
265 from the pressure waves propagation motion schematized in Fig. 11, that, at the beginning of the injection, the

266 fuel in the rail-to-injector pipe is accelerated toward the injector nozzle, due to the presence of the
267 expansion wave (1); the compression wave (2) then pushes the flow toward the nozzle, and, finally, even the
268 expansion wave (3) tends to accelerate the injected fuel. Instead, the compression wave (4) opposes the fuel
269 going toward the injector and, as a result, the measured flowrate features a maximum. For $ET \geq 2200 \mu\text{s}$ (cf.
270 Fig. 11), compression waves (2) and (5) help to push a flowrate into the injector, making the nozzle pressure
271 rise monotonically with respect to the time and, consequently, the increased injected flowrate makes the slope
272 of the $ET-M_{inj}$ injector characteristics augment (cf. Fig. 7). $ET = 2200 \mu\text{s}$ is the first value at which the
273 compression wave (2) has almost recovered the initial pressure drop, induced by the start of the injection,
274 within the nozzle.

275 As already presented in the literature [27]–[29], the mass entering the injector can be used to set up a closed-
276 loop strategy of the injected mass. If the flowrate time history that enters the injector is integrated till it reaches
277 its absolute minimum (cf. Fig. 8 at $t = 8.5 \text{ ms}$), a robust correlation between the injected fuel quantity (M_{inj}) and
278 the mass that enters the injector during an injection event ($M_{inj,in}$) can be obtained; such a correlation is reported
279 as a continuous line in Fig. 12, where the experimental points are plotted with symbols. In [27]–[29], the mass
280 entering the diesel Common Rail injector, $M_{inj,in}$, was obtained by ending the integration of the injector inlet
281 flowrate in correspondence to its absolute maximum value. This difference in the method can be ascribed to
282 the fact that, since the GDI injector pressure working range is much smaller than that of a diesel Common Rail
283 injector, the energizing times are generally much longer. Therefore, if one wants to select the absolute
284 maximum of the flowrate to terminate the integration of large ET s, the fuel injection would still be underway
285 at that time, and the obtained entering mass would not be fully representative of the injected one.

286 The scheme of a possible closed-loop control is represented in Fig. 13. During an injection event, p_{up} and p_{dw}
287 are measured by means of the Flotec flowmeter pressure sensors, which provide the flowrate that enters the
288 injector, namely $G_{inj,in}$ (cf. the red box in Fig. 13). The mass that enters the injector can be obtained by
289 integrating $G_{inj,in}$ with respect to time. This mass is used as input to obtain a prediction of the injected mass (cf.
290 the green box in Fig. 13), on the basis of the previously-determined correlation $M_{inj,pred} = f(M_{inj,in})$ represented
291 in Fig. 12. The $M_{inj,pred}$ value is then compared with the target value of the injected fuel quantity, i.e. $M_{inj,ref}$,
292 (this datum is stored in the ECU), and the $\Delta M_{inj} = M_{inj,ref} - M_{inj,pred}$ difference is generated (cf. the blue box in
293 Fig. 13). Such an estimation of the error in the injected mass is used as an input datum of a PID controller,

294 which gives an ET compensation, i.e. ΔET , as output in order to correct the possible inaccuracy of the fuel
 295 quantity injected during the engine cycle.

296 Such a control can be used, for example, to correct the injected mass inaccuracy for a fixed couple of nominal
 297 rail pressure level and energizing times, when the injector nozzle holes are affected by coking deposits [30],
 298 [31].

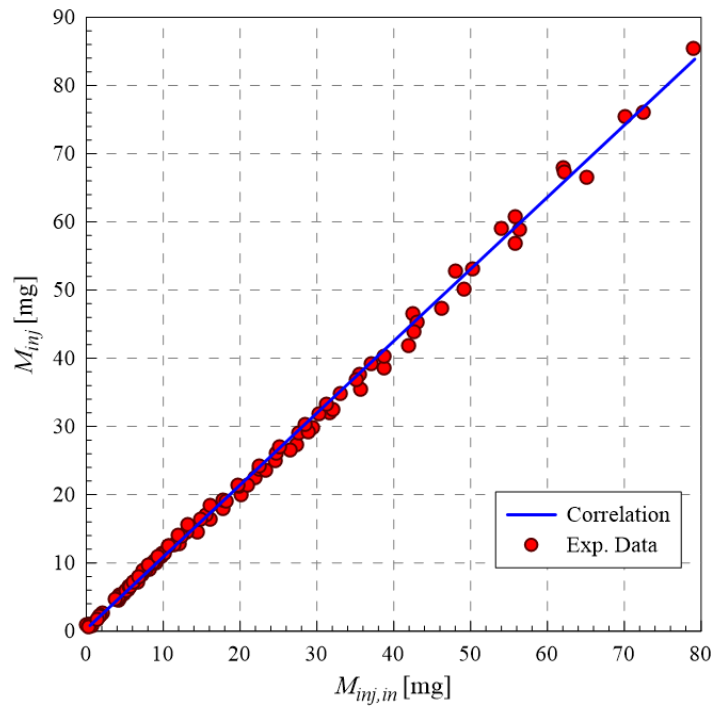

299
 300 Fig. 12- Correlation between the mass at the injector entrance and the injected one.

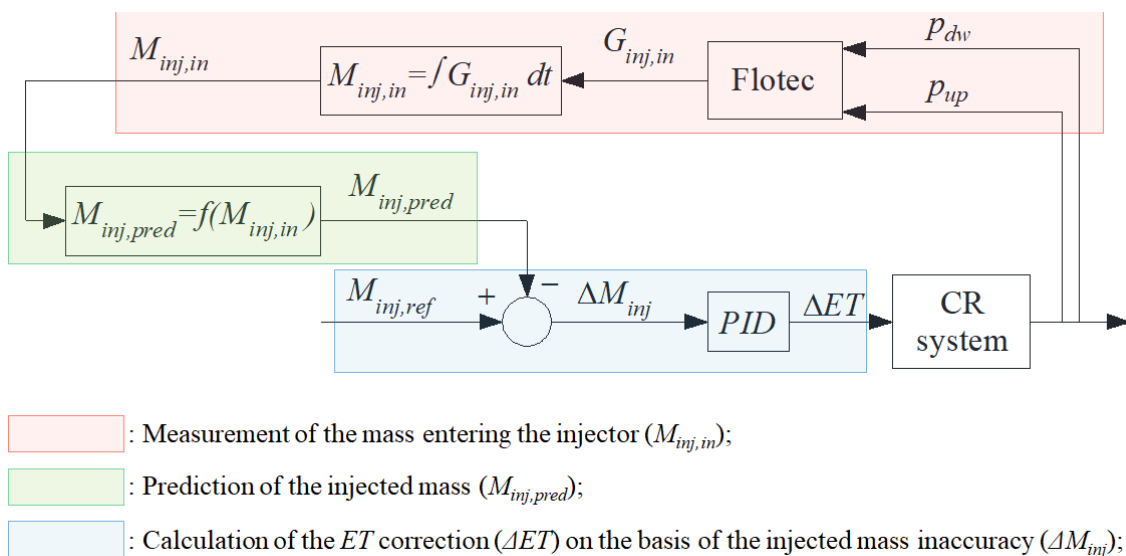

301
 302 Fig. 13 - Scheme of the closed-loop control for the injected mass.

303 6. Conclusions

304 The high-pressure, instantaneous, liquid flowrate along a pipeline has been measured by employing an
305 innovative flowmeter. This flowrate was obtained from two pressure signals, p_{up} and p_{dw} , measured at a
306 distance of 200 mm from each other, along the investigated pipe. The flowmeter algorithm combines the
307 momentum balance and the mass conservation equations for a 1D locally incompressible flow. The flowmeter
308 was employed to measure the flowrate that enters a GDI injector during operation. The injector was fed through
309 an 840 mm long pipe that had been equipped with the innovative flowmeter. A 1D numerical tool of the injector
310 plus its feeding line was realized to further assess the consistency of the measured flowrate that entered the
311 injector. This model receives the p_{up} pressure signal (used for the flowrate measurement) as a boundary
312 condition and the current and voltage to the injector solenoid as input signals. The model was then validated
313 successfully by means of comparisons between the numerical pressure time history at the location of the second
314 pressure transducer (p_{dw}) and the corresponding experimental trace, and by comparing the numerical injected
315 flowrate and the experimental trace, measured by means of a Bosch method-based low-pressure flowmeter.
316 Both single and pilot-main injections were considered, and the numerical outcomes accurately matched the
317 experimental traces for different working conditions. The $ET-M_{inj}$ injector characteristics showed two changes
318 in slope. It has been shown, using the numerical model, that the needle does not reach the end of its upstroke
319 over the first ET range ($ET < 550 \mu s$), and this leads to a sharp increase in M_{inj} with ET . When $ET > 550 \mu s$, the
320 flowrate starts to be controlled by the pressure drop across the nozzle holes, and the slope of the curve reduces.
321 An increment in the characteristic slope can be observed when $ET \geq 2200 \mu s$. It has been shown that, at the
322 beginning of the injection, the flowrate is accelerated toward the nozzle by an expansion wave that arises in
323 the nozzle, and that it is finally pushed toward the injector by a compression wave that comes from the rail.
324 When $ET \geq 2200 \mu s$, the nozzle pressure rises monotonically, due to a further flowrate that is pushed inside the
325 injector by two other compression waves. This pressure rise leads to an increased injected flowrate that makes
326 the slope of the injector characteristics augment. The flowrate that enters the injector can be integrated by
327 selecting two arbitrary time instants to obtain a mass. In this case, the integration was performed from the start
328 of the electric command up to the absolute minimum experienced by the measured injector-inlet flowrate. This
329 entering mass can be correlated to the outlet mass to set up a closed-loop control that can be employed to
330 modulate the ET during online injector operation. In fact, by means of the feedback signal of the mass that

331 enters the injector, a prediction of the effective injected fuel quantity can be determined on the basis of the
332 previously determined correlation. Thus, by comparing the mass prediction with the target value stored in the
333 ECU, the injected mass inaccuracy due, for example, to the presence of coking deposits on the nozzle holes or
334 to thermal drifts, can be corrected.

335 **Acknowledgments**

336 The research has received financial support in the frame of a national call for “Proof of Concept” projects,
337 promoted by the Fondazione Compagnia di San Paolo, LINKS Foundation and LIFTT.

338 **Nomenclature**

339	0D	zero-dimensional
340	1D	one-dimensional
341	3D	three-dimensional
342	A	pipe cross-section area
343	d	diameter, pipe diameter
344	DT	dwel time
345	ET	energizing time
346	F	force
347	FMV	fuel metering valve
348	G	mass flowrate
349	I	current signal
350	IA	injection analyzed
351	L_c	length of the annular passage
352	l	distance between the Flotec pressure sensors
353	M	mass
354	N	needle lift
355	p	flow pressure
356	PCV	pressure control valve
357	R	resistance
358	ℜ	reluctance
359	S	number of solenoid windings
360	t	time

361 u flow velocity
362 V voltage signal
363 v needle velocity
364 x spatial coordinate
365 ΔET energizing time correction
366 ΔM_{inj} difference between the reference injected mass and the predicted one
367 $\Delta \bar{\Gamma}_{faf}$ unsteady friction function
368 Δp pressure difference along the Flotec pipe
369 δ_r radial distance between the armature and the injector holder
370 Φ magnetic flux
371 μ flow dynamic viscosity
372 ρ flow density
373 τ_w wall shear stress
374 **Subscripts**
375 0 initial value
376 a armature
377 dw referring to the Flotec pressure sensor close to the injector
378 E electromagnetic
379 inj injected
380 inj, in entering the injector
381 $main$ main injection
382 max maximum
383 nom nominal
384 $nozzle$ referring to injector nozzle
385 pil pilot injection
386 $pred$ prediction
387 ref reference
388 up referring to the Flotec pressure sensor close to the rail
389 vis viscous friction

390 **References**

391 [1] A. E. Catania, A. Ferrari, and M. Manno, "Development and Application of a Complete Multijet
392 Common-Rail Injection-System Mathematical Model for Hydrodynamic Analysis and Diagnostics," *J*
393 *Eng Gas Turbine Power*, vol. 130, no. 6, Nov. 2008, doi: 10.1115/1.2925679.

- 394 [2] I. De Souza *et al.*, “Calibration of a Cryogenic Turbine-Based Volumetric Flow Meter (CTVFM)
395 Using Sub-Cooled Liquid Nitrogen and Solution for Its Practical Issues,” *IEEE Sens J*, vol. 21, no.
396 10, pp. 12077–12083, May 2021, doi: 10.1109/JSEN.2021.3065309.
- 397 [3] I. Gaskin, E. Shapiro, and D. Drikakis, “Theoretical, Numerical, and Experimental Study of the Time
398 of Flight Flowmeter,” *J Fluids Eng*, vol. 133, no. 4, Apr. 2011, doi: 10.1115/1.4003852.
- 399 [4] R. Cheesewright, K. N. Atkinson, C. Clark, G. J. P. ter Horst, R. C. Mottram, and J. Viljeer, “Field
400 tests of correction procedures for turbine flowmeters in pu satile flows,” *Flow Measurement and*
401 *Instrumentation*, vol. 7, no. 1, pp. 7–17, Mar. 1996, doi: 10.1016/0955-5986(96)00004-0.
- 402 [5] B. Lee, R. Cheesewright, and C. Clark, “The dynamic response of small turbine flowmeters in liquid
403 flows,” *Flow Measurement and Instrumentation*, vol. 15, no. 5–6, pp. 239–248, Oct. 2004, doi:
404 10.1016/j.flowmeasinst.2004.07.002.
- 405 [6] Z. Džemić, B. Širok, and B. Bizjan, “Turbine flowmeter response to transitional flow regimes,” *Flow*
406 *Measurement and Instrumentation*, vol. 59, pp. 18–22, Mar. 2018, doi:
407 10.1016/j.flowmeasinst.2017.11.006.
- 408 [7] J. Dong, C. Jing, Y. Peng, Y. Liu, H. Ren, and X. Liu, “Study on the measurement accuracy of an
409 improved cemented carbide orifice flowmeter in natural gas pipeline,” *Flow Measurement and*
410 *Instrumentation*, vol. 59, pp. 52–62, Mar. 2018, doi: 10.1016/j.flowmeasinst.2017.12.008.
- 411 [8] A. Raheem, A. S. B. Siddiqi, A. Ibrahim, A. Ullah, and M. H. Inayat, “Evaluation of multi-holed
412 orifice flowmeters under developing flow conditions – An experimental study,” *Flow Measurement*
413 *and Instrumentation*, vol. 79, p. 101894, Jun. 2021, doi: 10.1016/j.flowmeasinst.2021.101894.
- 414 [9] M. Moosa and M. H. Hekmat, “Numerical investigation of turbulence characteristics and upstream
415 disturbance of flow through standard and multi-hole orifice flowmeters,” *Flow Measurement and*
416 *Instrumentation*, vol. 65, pp. 203–218, Mar. 2019, doi: 10.1016/j.flowmeasinst.2019.01.002.
- 417 [10] V. P. Head, “Discussion: ‘Small-Diameter-Orifice Metering’ (Filban, T. J., and Griffin, W. A., 1960,
418 ASME J. Basic Eng., 82, pp. 735–738),” *Journal of Basic Engineering*, vol. 82, no. 3, pp. 739–739,
419 Sep. 1960, doi: 10.1115/1.3662732.
- 420 [11] E. O. Doebelin and D. N. Manik, *Measurement systems: application and design*. McGraw-Hill, 2007.
421 Accessed: Mar. 27, 2023. [Online]. Available:
422 https://inis.iaea.org/search/search.aspx?orig_q=RN:42014391
- 423 [12] T. Wang and R. Baker, “Coriolis flowmeters: a review of developments over the past 20 years, and an
424 assessment of the state of the art and likely future directions,” *Flow Measurement and*
425 *Instrumentation*, vol. 40, pp. 99–123, Dec. 2014, doi: 10.1016/J.FLOWMEASINST.2014.08.015.
- 426 [13] J. Zhao, L. Grekhov, and P. Yue, “Limit of Fuel Injection Rate in the Common Rail System under
427 Ultra-High Pressures,” *International Journal of Automotive Technology*, vol. 21, no. 3, pp. 649–656,
428 Jun. 2020, doi: 10.1007/s12239-020-0062-3.
- 429 [14] X. Li *et al.*, “Comparative Study on the Macroscopic Characteristics of Gasoline and Ethanol Spray
430 from a GDI Injector under Injection Pressures of 10 and 60 MPa,” *ACS Omega*, vol. 7, no. 10, pp.
431 8864–8873, Mar. 2022, doi: 10.1021/acsomega.1c07188.
- 432 [15] S. Gul, J. Shiriyev, V. Singhal, O. Erge, and C. Temizel, “Advanced materials and sensors in well
433 logging, drilling, and completion operations,” in *Sustainable Materials for Oil and Gas Applications*,
434 Elsevier, 2021, pp. 93–123. doi: 10.1016/B978-0-12-824380-0.00004-9.
- 435 [16] Kulite, *Innovative Piezoresistive Transducers*. 2007.

- 436 [17] A. Ferrari and T. Zhang, "Benchmark between Bosch and Zeuch method-based flowmeters for the
437 measurement of the fuel injection rate," *International Journal of Engine Research*, vol. 22, no. 1, pp.
438 316–327, Jan. 2021, doi: 10.1177/1468087419827732.
- 439 [18] A. Ferrari, Z. Jin, O. Vento, and T. Zhang, "An injected quantity estimation technique based on time-
440 frequency analysis," *Control Eng Pract*, vol. 116, p. 104910, Nov. 2021, doi:
441 10.1016/j.conengprac.2021.104910.
- 442 [19] A. Ferrari and P. Pizzo, "Optimization of an Algorithm for the Measurement of Unsteady Flow-Rates
443 in High-Pressure Pipelines and Application of a Newly Designed Flowmeter to Volumetric Pump
444 Analysis," *J Eng Gas Turbine Power*, vol. 138, no. 3, Mar. 2016, doi: 10.1115/1.4031541.
- 445 [20] A. Corvaglia, A. Ferrari, M. Rundo, and O. Vento, "Three-dimensional model of an external gear
446 pump with an experimental evaluation of the flow ripple," *Proc Inst Mech Eng C J Mech Eng Sci*,
447 vol. 235, no. 6, 2021, doi: 10.1177/0954406220937043.
- 448 [21] A. Ferrari, P. Fresia, M. Rundo, O. Vento, and P. Pizzo, "Experimental Measurement and Numerical
449 Validation of the Flow Ripple in Internal Gear Pumps," *Energies (Basel)*, vol. 15, no. 24, 2022, doi:
450 10.3390/en15249607.
- 451 [22] A. Ferrari and O. Vento, "Influence of Frequency-Dependent Friction Modeling on the Simulation of
452 Transient Flows in High-Pressure Flow Pipelines," *Journal of Fluids Engineering, Transactions of
453 the ASME*, vol. 142, no. 8, 2020, doi: 10.1115/1.4046623.
- 454 [23] G. K. Batchelor, *An Introduction to Fluid Dynamics*. Cambridge University Press, 2000. doi:
455 10.1017/CBO9780511800955.
- 456 [24] Z. Jin *et al.*, "Numerical-experimental optimization of the common-feeding injection system concept
457 for application to light-duty commercial vehicles," *Journal of Energy Resources Technology,
458 Transactions of the ASME*, vol. 143, no. 12, 2021, doi: 10.1115/1.4050133.
- 459 [25] A. Ferrari and O. Vento, "Thermal effects on Common Rail injection system hydraulic performance,"
460 *International Journal of Engine Research*, p. 146808742311624, Mar. 2023, doi:
461 10.1177/14680874231162412.
- 462 [26] M. Baratta, A. E. Catania, and A. Ferrari, "Hydraulic Circuit Design Keys to Remove the
463 Dependence of the Injected Fuel Amount on Dwell Time in Multi-Jet C.R. Systems," in *ASME 2006
464 Internal Combustion Engine Division Spring Technical Conference (ICES2006)*, ASMEDC, Jan.
465 2006, pp. 465–477. doi: 10.1115/ICES2006-1426.
- 466 [27] A. Ferrari, C. Novara, E. Paolucci, O. Vento, M. Violante, and T. Zhang, "Design and rapid
467 prototyping of a closed-loop control strategy of the injected mass for the reduction of CO₂,
468 combustion noise and pollutant emissions in diesel engines," *Appl Energy*, vol. 232, 2018, doi:
469 10.1016/j.apenergy.2018.09.028.
- 470 [28] A. Ferrari, C. Novara, E. Paolucci, O. Vento, M. Violante, and T. Zhang, "A new closed-loop control
471 of the injected mass for a full exploitation of digital and continuous injection-rate shaping," *Energy
472 Convers Manag*, vol. 177, 2018, doi: 10.1016/j.enconman.2018.08.037.
- 473 [29] A. Ferrari, C. Novara, O. Vento, M. Violante, and T. Zhang, "A novel fuel injected mass feedback-
474 control for single and multiple injections in direct injection systems for CI engines," *Fuel*, vol. 334,
475 2023, doi: 10.1016/j.fuel.2022.126670.
- 476 [30] F. Pickl, M. Russer, M. Hauenstein, and M. Wensing, "Modelling and understanding deposit
477 formation and reduction in combustion engines – Application to the concrete case of internal GDI
478 injector deposit," *Fuel*, vol. 236, pp. 284–296, Jan. 2019, doi: 10.1016/J.FUEL.2018.08.139.

479 [31] J. B. J. Reid *et al.*, “The Investigation of the Structure and Origins of Gasoline Direct Injection (GDI)
480 Deposits.,” Dec. 2019. doi: 10.4271/2019-01-2356.
481