

Strategies for a Positive Anthropogenic Impact in Postwar Buildings

*Original*

Strategies for a Positive Anthropogenic Impact in Postwar Buildings / Piantanida, Paolo; Ostorero, Carlo Luigi; Vottari, Antonio; Manni, Valentino; Valzano, Luca Saverio; Farnetani, Roberto; Surra, Marco. - In: SUSTAINABILITY. - ISSN 2071-1050. - ELETTRONICO. - 15:10(2023), pp. 7809-7834. [10.3390/su15107809]

*Availability:*

This version is available at: 11583/2978462 since: 2023-05-11T14:39:27Z

*Publisher:*

MDPI

*Published*

DOI:10.3390/su15107809

*Terms of use:*

This article is made available under terms and conditions as specified in the corresponding bibliographic description in the repository

*Publisher copyright*

(Article begins on next page)

## Article

# Strategies for a Positive Anthropogenic Impact in Postwar Buildings

Paolo Piantanida <sup>1,\*</sup>, Carlo Luigi Ostorero <sup>1</sup>, Antonio Vottari <sup>1,\*</sup>, Valentino Manni <sup>2</sup>, Luca Saverio Valzano <sup>2</sup>, Roberto Farnetani <sup>3</sup> and Marco Surra <sup>4</sup>

<sup>1</sup> Dipartimento di Ingegneria Strutturale Edile e Geotecnica (DISEG), Politecnico di Torino, Corso Duca degli Abruzzi n. 24, 10129 Torino, Italy

<sup>2</sup> Dipartimento di Architettura e Design (DAD), Politecnico di Torino, Corso Duca degli Abruzzi n. 24, 10129 Torino, Italy; valentino.manni@polito.it (V.M.); luca.valzano@polito.it (L.S.V.)

<sup>3</sup> Ingénierie & Energies Sarl, 44 Boulevard d'Italie, 98000 Monaco, Monaco; ingenierie\_energie.contact@monaco.mc

<sup>4</sup> Studio Surra, Piazza Martiri della Libertà n. 7, 10098 Rivoli, Italy; surra@studiosurra.it

\* Correspondence: paolo.piantanida@polito.it (P.P.); antonio.vottari@polito.it (A.V.)

**Abstract:** A significant portion of postwar buildings, typically concentrated in suburban areas, are now difficult assets to manage due to their poor sustainability and limited replacement feasibilities. This paper focuses on strategies to improve their metabolism using energy-saving measures based on optimizing energy needs and integrating internal and external energy sources: a new organizational model for energy management should focus first on saving energy, and then on the possibility of integration into a local energy network. This positively affects the anthropogenic impact and becomes a role model for aggregating buildings not only into a district system, but also into a wider, large-scale energy network. The paper shows a significant case study of actual retrofitting intervention that is examined in order to confirm the theoretical guidelines proposed in the first part of the paper. Moreover, another significant case study, taken from common practice, is illustrated, in which different levels of retrofitting are tested. While taking into account the complexity and fragmentation of private property both in a single building and in the city, some strategies are finally described with the aim of reducing the anthropic impact of the postwar building stock.

**Keywords:** postwar building stock retrofitting; energy saving; building sustainable refurbishment; retrofitting guidelines and techniques; energy community



**Citation:** Piantanida, P.; Ostorero, C.L.; Vottari, A.; Manni, V.; Valzano, L.S.; Farnetani, R.; Surra, M.

Strategies for a Positive Anthropogenic Impact in Postwar Buildings. *Sustainability* **2023**, *15*, 7809. <https://doi.org/10.3390/su15107809>

Academic Editors: Obuks Ejohwomu, Eziyi Offia Ibem and Olumuyiwa Adegun

Received: 22 October 2022

Revised: 27 April 2023

Accepted: 28 April 2023

Published: 10 May 2023



**Copyright:** © 2023 by the authors. Licensee MDPI, Basel, Switzerland. This article is an open access article distributed under the terms and conditions of the Creative Commons Attribution (CC BY) license (<https://creativecommons.org/licenses/by/4.0/>).

## 1. Introduction

The paper aims to highlight how awareness of the ecosystem issues represented by building heritages is relatively recent, particularly with reference to the size of Italy's postwar building stock, that is, the building stock built in Italy between 1945 and the 1970s. These buildings have often been recognized as one of the hottest issues due to their irrational use of nonrenewable energy sources, prompting reflections about the understanding of the use and function of the built heritage, understood as a complex system. The purpose of this article is, therefore, to solicit reflection on current methods of diagnosis and retrofit applied not only on an architectural scale but also on an urban scale.

### 1.1. The Weight of Buildings in Energy–Environmental Issues

Earth ecosystem protection and sustainable energy supply depends on the application of both policies for the development of new renewable sources and policies aimed at containing energy consumption.

In this outlined framework, data provided by the literature show that the building stock management and construction industries are among the sectors that have the greatest energy consumption and global fossil fuel emissions.

The Ecorys 2014 report [1] indicates that, in European countries, about 40% of total energy consumption and 30% of greenhouse gas emissions are attributable to the construction sector. On a global scale, the situation is equally critical (Figure 1) [2].

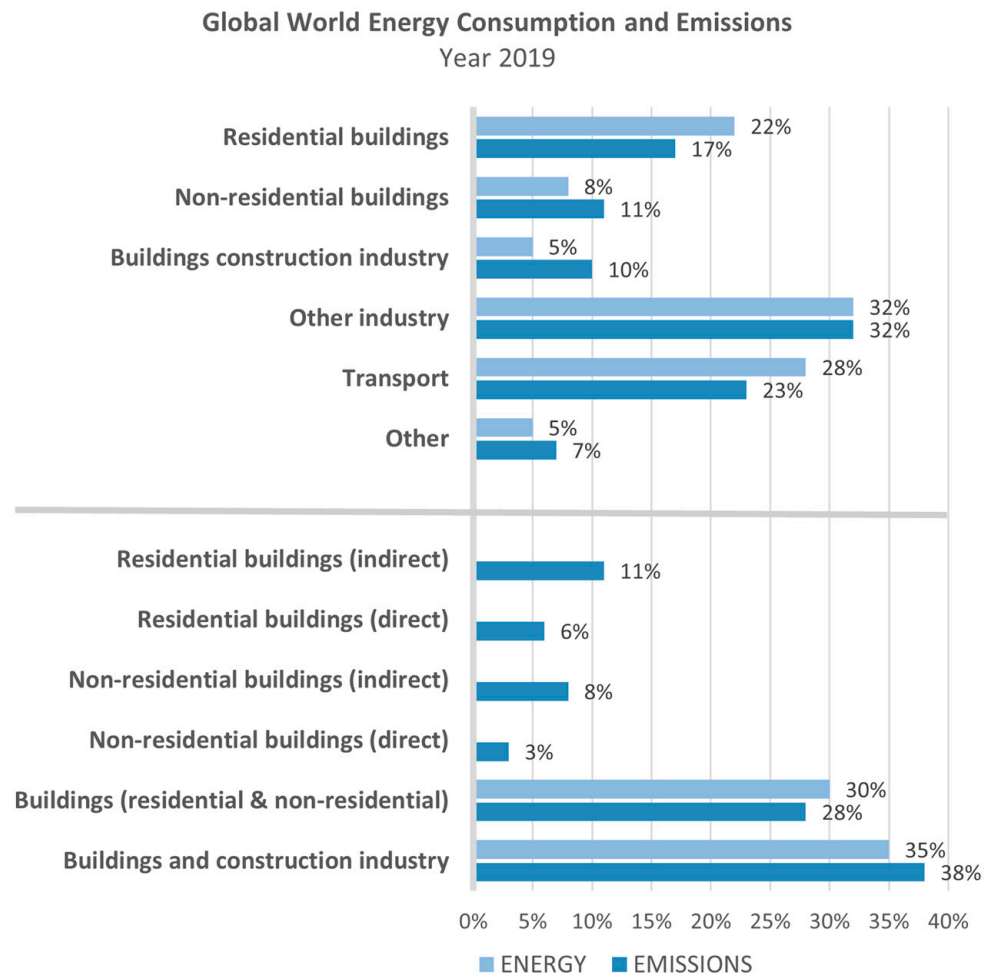

**Figure 1.** Global share of buildings and construction final energy and emissions, year 2019. Indirect emissions are emissions from power generation for electricity and commercial heat.

According to estimates by the Global Alliance for Buildings and Construction [3], 46% of the world's building stock still existing in 2050 will have been built between 2015 and that date. It is estimated that much of the growth will take place in countries in tropical climate, so the largest share of energy demand will be due to air cooling. Air cooling energy expenditure will equal that of heating in 2060 [4].

The goal is to produce building plant systems that are increasingly integrated and progressively less “energy-consuming” [5]. This integration is achieved in Passive Houses and Smart Buildings that can better manage energy by exploiting the Internet of Things (IoT) and Artificial Intelligence (AI) thanks to a more refined control capacity.

The evolution, from the second postwar period to the present, of the economic productive model and the technological changes induced in the building construction industry are the premises for the development of directions in the refurbishment of building stock.

### 1.2. Urban Growth in Italy since the Years of the “Economic Boom”

Between the end of Second World War and the 1970s, the world economy experienced a period of great prosperity. In this so-called Economic Boom, the idea that growth of wellbeing was an unstoppable phenomenon progressively consolidated [6].

In Italy, the increase in *per capita* income almost doubled [7] and low interest rates allowed many people to access credit and mortgages. Intervention plans by Italian State for construction of public housing, such as the one managed by the Ina-Casa Institute wanted to favor, in addition to the revival of construction sector, the absorption of a considerable number of unemployed and the construction of housing for low-income families. These initiatives played a leading role in increasing the amount of real-estate initiatives [8].

In 1951, almost 11 million occupied dwellings were registered, while in 1991, they had almost doubled, reaching the amount of almost 20 million units, up to about 24 million units in 2011 [9].

### 1.3. The 1970s: The Energy Crises and the Energy–Environmental Issue

Years of unstoppable economic development rooted the common mentality conviction that economic growth would be unlimited and that the depletion of energy resources would be a problem only far in the future.

In 1973, the Yom Kippur conflict, which broke out unexpectedly, changed such convictions, as OPEC's retaliation of crude oil supplies led to a sudden and substantial increase in the price of oil, which rose more than threefold in a short time.

Italy experienced the first crisis of energy shortage, which forced a reduction in heating expenditure and prevention of car use on Sundays.

A few years later, in 1979, the Iranian revolution and the subsequent war with Iraq led to a sharp decline in oil production and a further increase in oil prices that triggered strong inflation in all the industrialized countries [10].

The events that took place from 1973 to 1979 represented a watershed for energy policies in the years that followed. In fact, it made the debate on an ecologically compatible development model and on possible energy alternatives to oil and other fossil fuels progressively more and more central, favoring the spread of ecological awareness and giving strength to the demands promoted by the first environmental movements [11,12].

In the 1970s, the echo of some publications such as Rachel Carson's *Silent Spring* [13] marked the beginning of a phase called the Ecologist Spring. In Italy, the negative implications of the economic boom became recognizable with reflections in multiple spheres of society, including architectural design. In Italy, those reflections drove the "I International Biennial of Global Methodology of Design" in 1970 [14], while at the international level, the United Nations Organization convened the First Conference on the Human Environment in Stockholm in 1972.

In the same year, the Club of Rome released the report "The Limits to Growth", better known as the "Meadows Report" [15]. It predicted that economic growth could not continue indefinitely due to the limited availability of natural resources, especially oil, and the planet's limited capacity to absorb pollutants. This report attracted public attention to the closely related energy and environmental issues by announcing the depletion of fossil energy resources as predicted by the model developed by Hubbert [16].

In the years that followed, the trend in the consumption of fossil sources confirmed what was predicted in the "Meadows Report" rather well [17].

### 1.4. After the 1970s: An Emerging Regulatory Framework

In 1987, Brundtland's report "Our common future" highlighted the need to implement a strategy capable of integrating both the needs of development and the preservation of the environment, introducing the idea of sustainable development [18].

The report urged the UN to organize a conference that took place in Rio in 1992 and produced the so-called "Agenda 21", a document of intent in which the need for the creation of a fair global partnership was expressed to protect the integrity of the environment [19].

Further developments introduced by the Kyoto Protocol, developed in 1997 at the "Third Conference of the Parties (COP)", required developed countries to initiate a process of global collaboration, based on the centrality of climate problems in socioeconomic

development, with the purpose of pursuing certain goals in terms of reducing gas emissions for which they are mainly responsible.

The European Union adhered to the Kyoto Protocol, addressing its policies to the efficient use of energy, the development of renewable and low-emission sources, as well as issuing a series of European Directives regarding the energy efficiency of buildings.

The 2002/91/EC “Directive on the energy performance of buildings” set the objectives for reducing energy consumption and gas emissions and introduced new design standards. It required member states to ensure that both new and existing buildings undergoing major renovations met minimum energy performance requirements and introduced Energy Performance Certificates (EPCs), rating schemes to summarize the energy efficiency of buildings.

The European Directive 2010/31/EU introduced the concept of a Near-zero Energy Building (NZEB) as a building with high energy performance whose energy needs must be met, to a significant extent, by the use of renewable sources, including onsite production.

The Italian legislation transposed, in the building sector, the commitments of the Kyoto Protocol and the first European guidelines into national laws, among which were 120/2002 Act, 192/2005 Legislative Decree, and 102/2014 Legislative Decree “Energy Efficiency Decree” [20].

### 1.5. A New Energy Crisis

Although even in 2021 the trend of the energy price was increasing, nonetheless, Russia’s invasion of Ukraine has had far-reaching impacts on the global energy system, disrupting supply and demand patterns and fracturing long-standing trading relationships. It has pushed up energy prices for many consumers and businesses around the world, hurting households, industries, and entire economies [19].

But even before Russia’s invasion of Ukraine, the world was far off track from achieving its shared energy and climate goals. Global CO<sub>2</sub> emissions reached an all-time high in 2021, and fuel markets were already showing signs of strain.

At the same time, investment in clean energy technologies has remained far below the levels that are needed to bring emissions down to net zero by mid-century, a critical but formidable challenge that the world needs to overcome if it is to have any chance of limiting global warming to 1.5 °C, as the Net Zero by 2050 roadmap is aimed at the global energy sector [21].

Otherwise, world’s energy system is increasing in complexity. Electricity will be increasingly favored due to the development of electric mobility, electric heating, the greater diffusion of heat pumps, and access to electricity in geometric progression (Table 1).

**Table 1.** World need of electricity and energy (EJ).

Year	World Energy Final Consumption [EJ]		
	Total Energy	Electricity	Electricity as % of Energy
2019	427.1	80.4	18.8%
2030	491.4	109.0	22.2%
2040	544.3	135.8	24.9%
2050	592.3	161.4	27.2%

### 1.6. Energy Poverty

The growth of the world energy system’s complexity, as previously illustrated, exacerbates social problems that already afflict the most fragile consumers in many countries.

The European Commission defines energy poverty as the inability of families or individuals to access basic energy services that are needed to ensure a decent standard of living, such as heating, cooling, artificial lighting, and gas for cooking food [22]. An indicator of energy poverty is the incidence of energy expenditure on the overall income

of the family. The fight against energy poverty is part of the objectives of the Agenda 2030 of the United Nations Organization, signed in 2015. The program aims to “ensure access to affordable, reliable, sustainable and modern energy systems for all” (goals for sustainable development).

According to Eurostat, in 2020, 8% of the European population suffer from energy poverty [23]. In fact, the effects of a strong energy crisis could threaten the exercise of the right of access to energy. Up to now, this problem mainly concerned developing countries, but it could even extend to the countries of the First World.

Due to the actual critical situation, it is crucial to find viable local solutions to face the energy price crisis [24].

### 1.7. Energy Issues Related to the Italian Postwar Building Stock

There is a noticeable portion of Italian building stock, built during postwar period (precisely between 1946 and 1975), whose performance obsolescence and vulnerability is worsening its value and urban image.

The reconstruction of Italian cities following the Second World War made it necessary to carry out numerous interventions often carried out in ways that were not in keeping with the quality required by a correct building technique. The scarce economic resources and the urgency imposed by the scarcity of available housing imposed a speed of intervention not suitable for reaching satisfactory quality levels.

To cope quickly and affordably to the housing emergency, new technological solutions spread and consolidated, favoring the use of local construction techniques and materials, with the purpose of encouraging employment in the building sector.

A certain typology of the building stock, particularly in the biggest urban centers, consisted of multistory residential buildings and adopted reinforced concrete (RC) structural frames and nonstructural masonry infills.

Our research addresses this constructive conception due to its diffusion and to its suitability to be retrofitted, preserving their value.

Generally, those buildings were characterized by double-leaf hollow clay masonry with a non-insulated cavity. Thermal transmittances (U) of this building envelope had typically higher values compared to current standards (Table 2).

**Table 2.** Typical Italian U-values (thermal transmittances) in the 1950s and 1960s building stock, deduced by the Authors on a statistical base from previous research.

Building Elements	Typical Thermal Transmittance (U)
Reinforced concrete structures	2.20 W/m <sup>2</sup> K
Brick walls without insulation camera	2.00 W/m <sup>2</sup> K
Beams and clay block floors	2.10 W/m <sup>2</sup> K
Windows (single-glazed, sp. < 3 mm)	5.50 W/m <sup>2</sup> K

The architecture of that time only entrusted the function of visual screen and shelter from meteorological agents to the envelope, the task of creating a comfortable microclimate was relegated to the heating plant. Environmental control was mainly based on the exploitation of nonrenewable energy sources.

The changed attitude to oil consumption produced by energy crises led many governments of industrialized countries to launch policies aimed at energy saving. In Italy, after the crisis of 1973, new strict policies gave rise to so-called ‘austerity’, which affected the construction sector, as well. In June 1976, the first Italian legislation was issued to contain energy consumption for thermal uses in buildings.

It limited the thermal power of the heating systems and imposed, in the design phase, the verification of the dispersion coefficient (Cd), the representative parameter of geometric characteristics of the building. The concept of degrees-day (GG) was introduced as well.

From a design point of view, more attention began to be paid to the heat loss of the building envelope.

The technological impact consisted of the large-scale introduction of insulant materials. This was also possible thanks to the spread of construction techniques already partially consolidated in those years, characterized by a loadbearing skeleton in reinforced concrete beams and pillars and by two layers of perforated brick infill with an interposed cavity [5]. Table 3 shows the most representative values of the technological solutions used in those years.

**Table 3.** Typical Italian U-values (thermal transmittances) in the 70s building stock, deduced by the authors on a statistical base from previous research.

Building Elements	Typical Thermal Transmittance (U)
Reinforced concrete structures	2.20 W/m <sup>2</sup> K
Brick walls with insulation camera	0.90 W/m <sup>2</sup> K
Beams and clay block floors	0.90 W/m <sup>2</sup> K
Windows (single-glazed, sp. < 3 mm)	5.50 W/m <sup>2</sup> K

Nowadays, the Italian postwar building stock is at least 60 years old; therefore, most of its buildings are at the end of their (designed) service life, and they are usually affected by performance obsolescence, high seismic vulnerability, and living discomfort, especially for that substantial quota with inadequate maintenance status.

By now there is no doubt about how much this residential building stock represents a difficult heritage, because of the progressive loss of its value and stiffness in meeting the new housing needs.

Even though a large-scale construction replacement seems to apparently be the expected way to solve the problem, the need to preserve an architecture, often authorial, that testifies to the culture of an important period in Italian history and current global strategies towards built environment demand different approaches.

## 2. Objectives and Methodology of the Research

### 2.1. Objectives of the Research

New approaches in retrofitting are needed that could either valorize most of this building stock and allow for the accomplishment of a refurbishment capable of reviving these architectures, according to the needs of the contemporary living, contrasting social problems such as energy poverty and achieving a positive anthropogenic impact.

The anthropogenic impact on a built heritage means the combination of positive and negative influences that the use of energy, soil, and natural resources available to the city and its inhabitants has on the future generation's availability of the same.

It is possible to act upon two complementary aspects of the energy management of the built environment. The first one is the improvement in energy efficiency, with the purpose of reducing energy needs and consumption, while the second is the adoption of management models of energy, such as energy communities, which can make it possible to cut the price of the energy. Both aspects are mutually connected and can be synergistic in achieving a positive anthropogenic impact on the built environment.

Building energy efficiency is increasingly recognized as the most effective way to reduce CO<sub>2</sub> emissions linked with climate change. Simple measures, such as a more careful lighting energy use; better insulation; more efficient building glazing; and heating, ventilation, and air-conditioning (HVAC) systems could significantly reduce carbon dioxide emissions and represent a net economic gain for society [25].

Generally, the energy retrofit of the building, achievable through the amelioration of the insulation of the envelope, window replacement, the improvements to envelope airtightness and installation or the replacement of plants, is justified according to energy conservation. Interventions are usually expensive because they require labor-intensive

modifications, such as additions to or replacements of parts of the technological building system. Otherwise, the building envelope retrofits may be justified for reasons other than energy efficiency, such as an increase in indoor thermal comfort [26].

The objective of this research is the development of a framework according to which energy efficiency retrofit measures can be assessed in the postwar Italian building stock. Energy savings are estimated in a relatively straightforward manner by applying retrofitting measures to the model of a representative building belonging to the Italian postwar building stock. Then, this research estimates the energy performance index (EPI), which represents the impact that different interventions would have on the annual energy demand.

These retrofits have been evaluated not only based on the savings that can be achieved but also in terms of their CO<sub>2</sub> abatement potential, which can depict anthropogenic impact.

The results of this research can be useful for drawing a framework of guidelines that can be used as a decision support tool for refurbishment and retrofitting interventions regarding the Italian postwar building stock.

## 2.2. Methodological Premises

As previously illustrated, the refurbishment of Italian postwar buildings can be carried out using two synergic actions. The first one is aimed at reducing energy need and consumption, while the second one is aimed at reducing the cost of the energy through more rational use of it.

The knowledge and the clear understanding of the functioning of constructive technologies of the postwar building stock are necessary premises to the application of such actions. The research examines the most common technological solutions to the Italian postwar building stock.

Once the comprehension of technology is acquired, it is possible to draw a framework of retrofitting strategies and approaches, compatible with the characteristics of the building stock, aimed at energy consumption reduction. A framework of measures is proposed according to their features.

The application of energy management models, based on self-production, self-consumption, and sharing, can empower global retrofitting action through the reduction in the cost of the energy. The management model of energy communities is offered as a viable solution in the consolidated built environment, characterized by both cultural and authoritative value and socioeconomic problems.

The achievement of positive anthropogenic impact may be the result of the synergic actions of both energy need and consumption reduction and energy cost reduction, with a drawback on the ecological footprint of the building stock.

A case study is reported with the purpose of carrying out an assessment of the application of the abovementioned retrofitting actions to demonstrate the achievability of both energetic and environmental benefits.

The ecological footprint is determined by the calculation of the abatement of CO<sub>2</sub> release into the atmosphere.

## 2.3. Understanding the Technology of Italian Postwar Buildings

In order to correctly identify any strategy, it is important to analyze the targeted building stock in relation, e.g., to a building's dimensions and shape, generic structural configuration, and technological details of its existing envelope (as exemplified in Figure 2), which play a crucial role in any systemic retrofitting strategy aimed at enhancing not only indoor comfort and building performance, but also functional improvement, environmental footprint and its resilience towards climate and users' needs, also with positive fallouts for the environment and urban image.

## Building Analysis Process

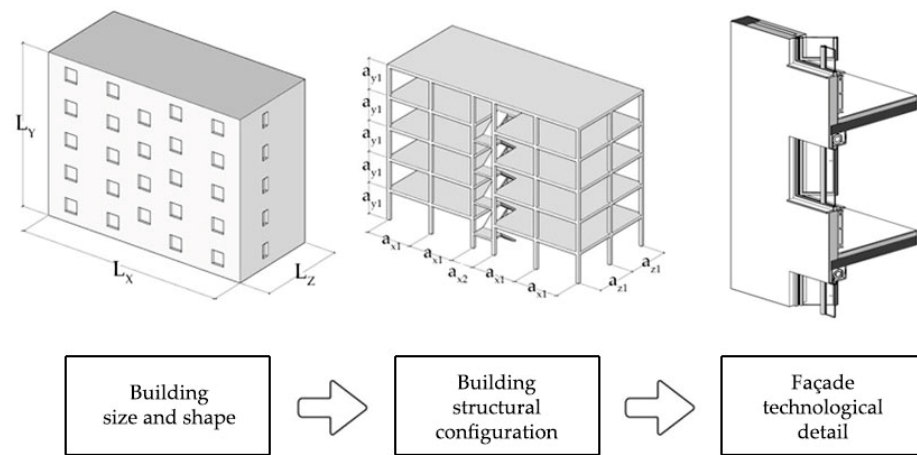

**Figure 2.** Sampling scheme of targeted postwar building analysis process, aimed at outlining existing envelope.

In particular, with regard to the close connection between a reinforced concrete frame structure and traditional vertical envelope, it is important to notice that the latter is basically an external infill walling and not a curtain covering: this specificity is a key element to fully understanding the performance and functional deficiencies of postwar buildings, in addition to low-quality materials, lack of thermal insulation, and constructional criticalities, which all belong to the building practices of the postwar reconstruction period. A postwar building's vertical envelope consists of an RC structural frame and nonstructural masonry infills, generally made of double-leaf hollow clay masonry, almost independent each other, and a non-insulated cavity, generally used to host the central heating piping. The external leaf is often made of facing bricks, or otherwise has simple cement plaster cladding. By detailing the beam–column joint, regardless of any declinations for composition and architectural image needs, it is possible to identify a few recurrent cases, as illustrated below in Figure 3.

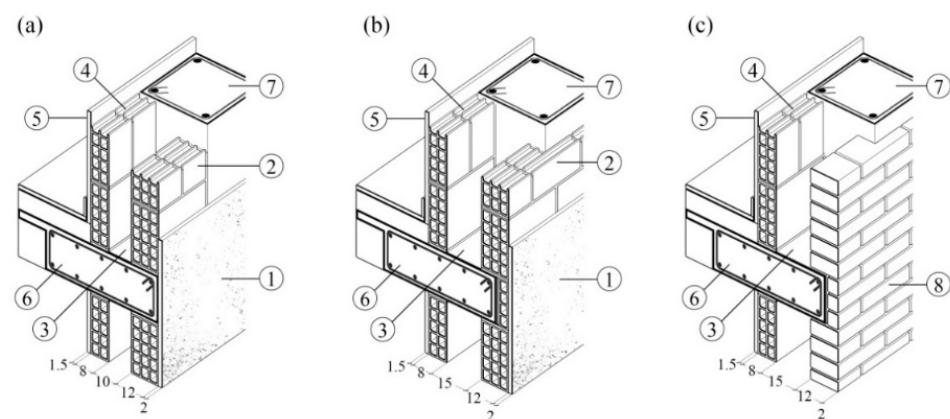

## Legend:

- |                                     |                               |
|-------------------------------------|-------------------------------|
| 1 external cement plaster cladding  | 5 interior gypsum plaster     |
| 2 hollow clay masonry external leaf | 6 RC beam                     |
| 3 non-insulated cavity              | 7 RC column                   |
| 4 hollow clay masonry internal leaf | 8 facing bricks external leaf |

**Figure 3.** Representative cases of beam-column joint typologies in postwar buildings' vertical envelope: (a) edge beam and column bare; (b) edge beam and column clad; (c) edge beam and column with brick façade. Source: authors' elaboration.

The complete lack of thermal insulation and the use of low-quality materials are the main reasons for poor energy performance in postwar building envelopes: the average U-value is around  $1.8 \text{ W/m}^2 \text{ K}$  with reference to Figure 3, case (a), far from the standards required today.

This type of building stock had the goal of capturing and pleasing buyers using an envelope claiming modernity, comfort—and even some luxury—after hard war times. New shapes and shiny material claddings, suggesting a lasting and stylish image, faded out the fact that façades are intended to manage the in/out bond in charge of a great part of a building’s metabolism. With low-cost and powerful central heating systems, large windows and, sometimes, holiday homes at hand, seemed to solve any comfort issue in winter and summer, since there was absolutely no widespread sensitivity towards environmental pollution and sustainability.

In the 1970s, the oil crisis shock caused awareness of the building envelope’s metabolic interface function to reappear in evaluation and property management criteria. But in the following decades, 1950s and 1960s envelope design criteria were misunderstood, even if they were only ten or twenty years old: in those façades, the active energy supply (heating system) and passive energy control (thermal insulation) were conceived in a synergistic (and very energy exhaustive) way. All the nude (not insulated) heating pipes in the wall cavity worked both as an anti-dew system and a pre-heater for the façade’s inner (and outer, unfortunately) surfaces: in that way, indoor comfort was increased for the radiant temperature and for the wall dew point, paying for more oil instead providing thermal insulation and a vapor barrier. In the following decades, the increasing heating costs suggested a thermal insulation retrofitting that set apart these two energy spheres (active and passive): the façade’s original metabolic system was deeply modified and mold often appeared.

#### 2.4. Retrofit Strategies for Energy Consumption Reduction

The comprehension of how both the building envelope and the heating system used to work synergistically in post-war building stock induces research to identify tailor-made solutions in relation to each case that do not alter the dynamics and the original functioning of the building plant system, while allowing an adaptation to the needs of contemporary living.

Retrofitting measures can be driven by different approaches and strategies (Table 4). Approaches can be additive (when new components of the building system are added) or substitutive (when existing components of the building system are substituted). Strategies can be passive (when retrofitting measures are aimed at energy containment) or active (when retrofit measures are aimed at better energy generation and management). It should be emphasized that intervention using substitutive approaches entails having to face the problem of the relocation, even temporarily, of residents. Although the relocation of inhabitants is possible in the case of a single owner (private tenant or real estate player), this becomes problematic in the case of property fragmentation, as it is typical in Italian building stock.

**Table 4.** Retrofitting strategies and approaches.

	Additive Approach	Substitutive Approach
Passive strategy	Passive strategy, Additive approach Limitation of energy consumption by the installation of new technical elements to the building system	Passive strategy, Substitutive approach Limitation of the energy consumption by the substitution of existing technical elements of the building system
Active strategy	Active strategy, Additive approach Energy generation or management by the installation of new technical elements of the building system	Active strategy, Substitutive approach Energy generation or management by the substitution of the existing technical elements of the building system

A representative example of the best intervention technique aimed at minimizing the anthropogenic impact, by carrying out retrofitting actions on a 1963 building, is represented by the project “The Black One” (Figure 4), developed in 2020, by + Studio Architects and Mediapolis Ingegneria [27]. It is a radical retrofitting intervention of a ten-level, 38-apartment postwar building in Turin, Italy, consisting of the full substitution of the building envelope and plant system and anti-seismic strengthening of the frame-reinforced concrete structure (Tables 5 and 6).



**Figure 4.** “The Black One”, images of the building site. (a) First phase of the building envelope’s substitution; (b) preliminary phase of the anti-seismic structural reinforcement; (c) the building before the retrofit intervention; (d) the building after the retrofit intervention (photo a, b by Lonero G.) [28].

**Table 5.** “The Black One”, anthropogenic impact data comparison.

<b>“The Black One” Anthropogenic Impact Reduction Due to Retrofitting Intervention</b>	
<i>Before the intervention</i>	<i>After the intervention</i>
Seismic Structural Class: F	Seismic Structural Class: D
Energy Performance Class: G (160 kW/m <sup>2</sup> y)	Energy Performance Class: A3 (0.4 ÷ 0.6 kW/m <sup>2</sup> y)

**Table 6.** “The Black One”, costs of retrofitting intervention.

<b>“The Black One” Costs of Retrofitting Intervention</b>	
Total cost of the intervention	EUR 9,000,000
Total flat square meter cost	1940 EUR/m <sup>2</sup> (4540 m <sup>2</sup> )
Total seismic structural reinforcement cost	EUR 950,000 210 EUR/m <sup>2</sup>
Total façade retrofitting cost	EUR 600,000 (2800 m <sup>2</sup> ) 215 EUR/m <sup>2</sup>

As shown in the tables provided, the “Black One” intervention is a remarkable case study due to both the lowering of anthropogenic impact and the comprehensive design techniques adopted on a whole building, due to the property being single.

The retrofitting intervention presented the opportunity not only to improve the overall energy performance of the building but also to achieve a new characterizing architectural image of the regenerated city.

#### *Professional Credits*

Building design: Studio Pralavorio (Geom. Pralavorio G.M., Geom. Pralavorio A. with Arch. Pasini J. and Arch. Di Giovanni P.)

Structural design: Eng. Lonero G.

Safety coordination on construction site: Eng. Lonero G.

HVAC design: Eng. Trimboli U.

Electrical plant design: P.I. Crudo L.

Acoustic design: Eng. Soffredini A.

Fire safety engineering: Arch. Corba G.

#### *Developer Credits*

Real estate developer: SDS S.r.l., Settecasi family

#### *Building Company Credits*

Building company: Fiammengo Federico S.r.l., 7 Real Estate S.r.l.

Glazed element supplier: SEPAM S.r.l.

Ventilated façade: FLORIM S.p.A.

Landscape design: DECO’—RB Solution

### **3. A Case Study Based on Common Retrofitting Practice**

#### *3.1. Description of the Case Study*

Considering what has been discussed so far, it may be interesting to test what the improvement in energy footprint is due to upgrading the building envelope and revamping the HVAC system on a real case. The case study was chosen to represent typical middle-class housing project in Northern Italy in the 1950s and, more generally, the situation of the housing stock rebuilt after World War II.

The building upon which some energetic retrofitting intervention scenarios were hypothesized was built in Turin and represents an example of the building typology and construction techniques most commonly adopted for the reconstruction of the Italian city in the 1950s (Figures 5 and 6).

The building is 4 levels high within a basement partially confining with the exterior and consists of 43 residential apartments. Its main façade is 60 m long. The building is mostly oriented to the south (main front) and north (internal courtyard). It is disengaged by five stairs and is not equipped with any lift.

The housing complex has a floor surface of about 2770 m<sup>2</sup>, a gross heated volume of 10,800 m<sup>3</sup>, and a cold envelope of 4920 m<sup>2</sup> (form factor of 0.45).

The structural organism consists of a frame with beams and pillars in reinforced concrete. The floors are made using 250 mm thick reinforced brick concrete (RBC) slabs. The structure of the sloping roof is wooden. The roof covering made of clay tiles and is not insulated.

Without the aid of destructive tests on the surfaces, also thanks to the analysis of the project documents deposited in the Building Archives of the City of Turin, it was possible to reconstruct the stratigraphic composition of the building envelope.

The opaque infill of the vertical envelope is from 400 mm to 500 mm thick and is made using clay masonry made up of a double layer of perforated bricks placed in offset to create an inner cavity. The infill is inserted inside the structural reinforced concrete frame and is not thermally insulated.

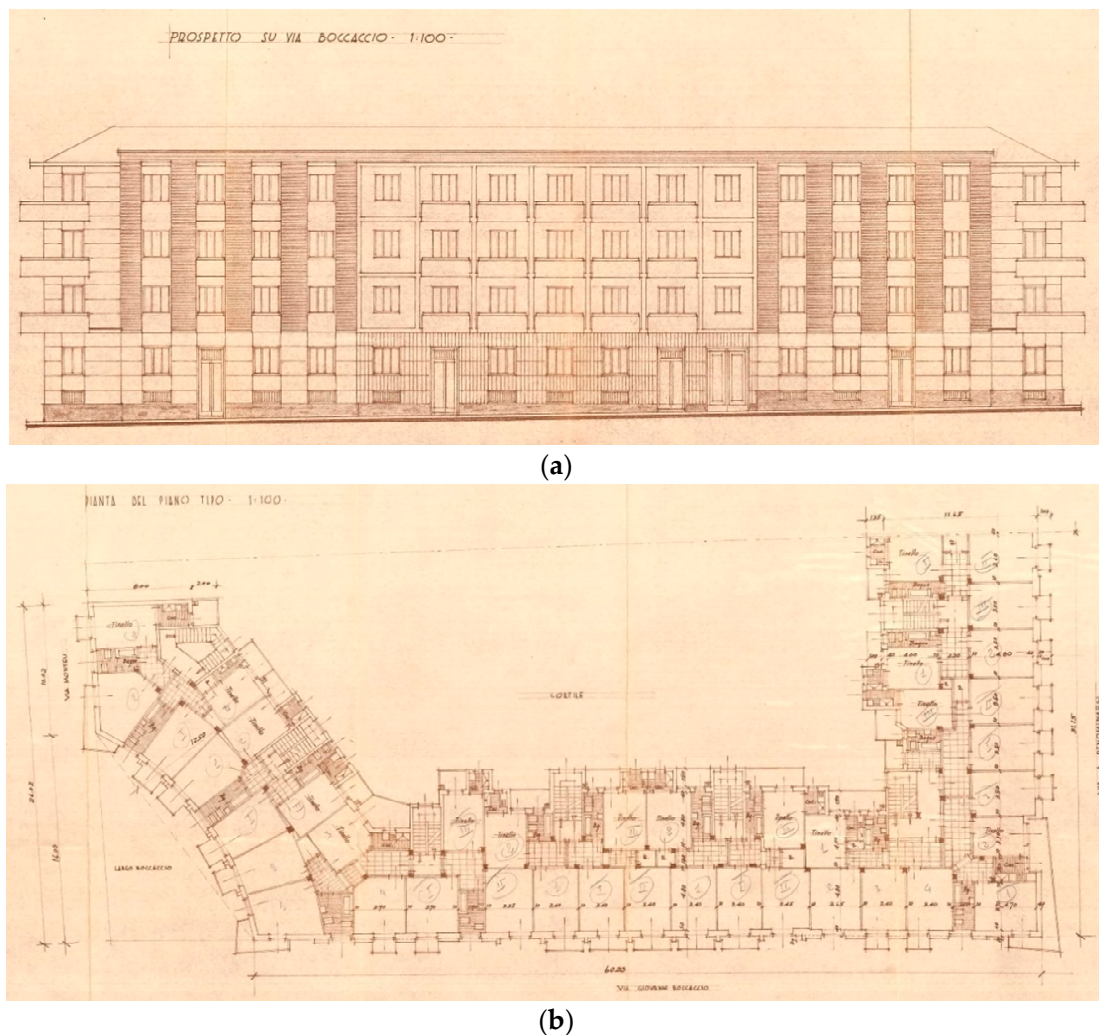

Figure 5. Case study building. (a) Main façade; (b) model floor plan [29].



(a)



(b)



(c)



(d)

**Figure 6.** (a) West façade (cladded in plaster and Vicenza stone); (b) portion of the main façade (cladded in plaster and clinker); (c) portion of the main façade (cladded in plaster); (d) courtyard view.

The envelope cladding is characterized by finishing in different materials, according to the architectural design of the portions of the façades: Vicenza stone, clinker tiles, and plaster (especially in the courtyard).

Windows are extremely heterogeneous. In fact, over time, many of the original wooden window frames have been replaced with aluminum alloy or PVC, without any proper plan for replacement interventions. The original wooden windows do not have airtight gaskets and are single-glazed with a glass thickness of 3 mm.

The concrete-bearing elements jut out from the envelope surfaces to enhance the structural matrix, but this compositional expedient causes inhomogeneity of the envelope transmittances and variable energy dispersions. The horizontal and vertical elements of the structural framework, directly bordering the external environment, constitute a thermal bridge. The first floor consists of the basement, which contains unheated garages and technical rooms.

### 3.2. Energy Efficiency Assessment

The thermographic investigation carried on the building envelope revealed a poor performance level in relation to the containment of heat dispersion (Figure 7), as summarized in Table 7.

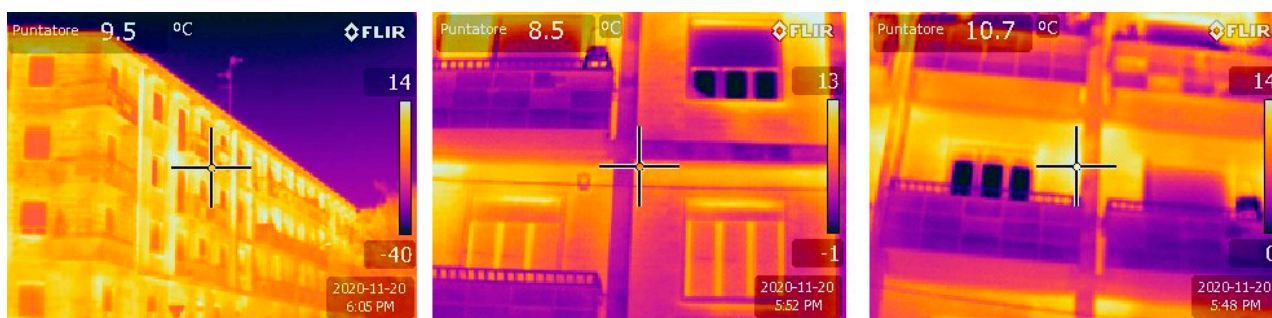

**Figure 7.** Thermographic analysis of the building envelope. Images taken by the authors.

**Table 7.** Case study on geometrical and thermophysical data (present status).

<i>Geometrical Data of the Case Study</i>	
Total cold envelope surface	4920 m <sup>2</sup>
Total opaque envelope surface	4445 m <sup>2</sup>
Total glazed envelope surface	475 m <sup>2</sup>
Total climatized floor surface	2780 m <sup>2</sup>
Total climatized volume	8320 m <sup>3</sup>
Form factor ( $S_{\text{cold envelope}}/V_{\text{climatized}}$ )	0.45
<i>Thermophysical Data of the Case Study</i>	
Average transmittance of the opaque envelope	0.89 W/m <sup>2</sup> K
Average transmittance of windows	3.08 W/m <sup>2</sup> K
Average transmittance of basement roof	1.31 W/m <sup>2</sup> K
Average transmittance of the roof of the building	1.60 W/m <sup>2</sup> K
Energy performance index from nonrenewable sources ( $EPI_{\text{gl,nren}}$ )	179.43 Wh/m <sup>2</sup> ·y

Taking advantage of the acquired data, a digital model of the building was obtained, and various retrofitting options were simulated with “Edilclima release EC700”, which is a software package validated by the Italian Thermotechnical Committee. Estimates of the energy performance of the building were made according to the Italian technical standard UNI-TS 11300. Then, some scenarios were assumed in which the increase in energy efficiency was evaluated in relation to the application of different technological retrofitting measures. This step made it possible to show the progressive decrease in ecological footprint and the increase in energy efficiency of the building.

### 3.3. Description of the Retrofit Measures and Scenarios

The described retrofitting measures adhere to both passive and active strategies based on both substitutive and additive approaches, as shown in Table 8, in order to gain the scenarios in Table 9.

### 3.4. Results

The model first returned a primary energy consumption index  $EPI_{\text{gl,nren}}$  for winter heating of 179.43 kWh/m<sup>2</sup>·year, which places the current building in the Italian energy class F. The progressive application of energy efficiency interventions, selected from those suitable for that building, has shown the application of some retrofitting strategies, both envelope and HVAC system oriented, allows the building to reach the threshold of Italian energy class B with an  $EP_{\text{gl,nren}}$  consumption index of 70.39 kWh/m<sup>2</sup>·year. The strategy and results are illustrated in Tables 10 and 11.

**Table 8.** Case study retrofitting measures.

Description of Retrofitting Measures	
Measure 1 Passive strategy Additive approach	Interventions on the opaque envelope (estimated service life 50 years) Total surface = 3340 m <sup>2</sup> $U_{\text{average}} = 0,21 \text{ W/m}^2 \cdot \text{K}$ Street façades: application of an external thermal coating in aerogel panels (thermal conductivity ( $\lambda$ ) = 0.015 W/m·K, thickness 50 mm) Courtyard façades: application of an external thermal coating in EPS panels (thermal conductivity ( $\lambda$ ) = 0.031 W/m·K, thickness 100 mm) Basement ceiling: thermal insulation in graphite EPS panels (thermal conductivity ( $\lambda$ ) = 0.031 W/m·K, thickness 120 mm) Roof: application of PUR multilayer panels under clay tiles (thermal conductivity ( $\lambda$ ) = 0.024 W/m·K, thickness 120 mm)
Measure 2 Passive strategy Substitutive approach	Intervention on the glazed envelope (estimated service life 30 years) Total surface = 475 m <sup>2</sup> Windows: replacement of every single-glazed window with double-glazed windows ( $U_w = 1.30 \text{ W/m}^2 \cdot \text{K}$ )
Measure 3 Active strategy Substitutive approach	Installation of heat pumps (estimated service life 15 years) Replacement of the gas boiler for domestic hot water with a hybrid system twining a condensing boiler (output power 188.7 kW) and an air-to-water heat pump (output power 75.5 kW)
Measure 4 Active strategy Additive approach	Intervention on the heating plant (estimated service life 15 years) Installation of a centralized HP DHW and storage tank for HP heat pumps
Measure 5 Active strategy Additive approach	Installation of a photovoltaic plant (estimated service life 25 years) Installation of photovoltaic panels on the roof (total peak power 50 kW)

**Table 9.** Case study retrofitting scenarios.

Description of Retrofitting Scenarios	
Scenario 0	Baseline scenario This configuration is the benchmark for further comparisons. The building is assumed with its original configuration
Scenario 1	Application of Measure 1: retrofitting of the opaque envelope
Scenario 2	Application of Measure 1: retrofitting of the opaque envelope Measure 2: retrofitting of the glazed envelope
Scenario 3	Application of Measure 1: retrofitting of the opaque envelope Measure 2: retrofitting of the glazed envelope Measure 3: installation of heat pumps
Scenario 4	Application of Measure 1: retrofitting of the opaque envelope Measure 2: retrofitting of the glazed envelope Measure 3: installation of heat pumps Measure 4: substitution of centralized HP DHW
Scenario 5	Application of Measure 1: retrofitting of the opaque envelope Measure 2: retrofitting of the glazed envelope Measure 3: installation of heat pumps Measure 4: substitution of centralized HP DHW Measure 5: installation of a photovoltaic plant

**Table 10.** Case study of retrofitting measures.

Description of Retrofitting Measures	
Measure 1 Passive strategy Additive approach	Interventions on the opaque envelope (estimated service life 50 years) Total cost = EUR 691,210 $EPI_{gl,nren} = 105.84 \text{ kWh/m}^2 \cdot \text{yr}$
Measure 2 Passive strategy Substitutive approach	Intervention on the glazed envelope (estimated service life 30 years) Total cost = EUR 370,500 $EPI_{gl,nren} = 140.88 \text{ kWh/m}^2 \cdot \text{yr}$
Measure 3 Active strategy Additive approach	Installation of heat pumps (estimated service life 15 years) Total cost = EUR 140,430 $EPI_{gl,nren} = 129.63 \text{ kWh/m}^2 \cdot \text{yr}$
Measure 4 Active strategy Substitutive approach	Substitution of centralized HP DHW (estimated service life 15 years) Total cost = EUR 84,800 $EPI_{gl,nren} = 170.48 \text{ kWh/m}^2 \cdot \text{yr}$
Measure 5 Active strategy Additive approach	Installation of a photovoltaic plant (estimated service life 25 years) Total cost = EUR 96,000 $EPI_{gl,nren} = 178.29 \text{ kWh/m}^2 \cdot \text{yr}$

**Table 11.** Case-study retrofit scenarios.

Description of Retrofitting Scenarios		
Scenario 0	Baseline	$EPI_{gl,nren} = 201.04 \text{ kWh/m}^2 \cdot \text{yr}$
Scenario 1	Measure 1	$C_{tot} = \text{EUR } 691,210$ $EPI_{gl,nren} = 105.84 \text{ kWh/m}^2 \cdot \text{yr}$
Scenario 2	Measures 1, 2	$C_{tot} = \text{EUR } 1,061,710$ $EPI_{gl,nren} = 75.60 \text{ kWh/m}^2 \cdot \text{yr}$
Scenario 3	Measures 1, 2, 3	$C_{tot} = \text{EUR } 1,202,140$ $EPI_{gl,nren} = 68.64 \text{ kWh/m}^2 \cdot \text{yr}$
Scenario 4	Measures 1, 2, 3, 4	$C_{tot} = \text{EUR } 1,286,940$ $EPI_{gl,nren} = 39.23 \text{ kWh/m}^2 \cdot \text{yr}$
Scenario 5	Measures 1, 2, 3, 4, 5	$C_{tot} = \text{EUR } 1,382,940$ $EPI_{gl,nren} = 23.51 \text{ kWh/m}^2 \cdot \text{yr}$

#### 3.4.1. Passive Strategies: The Additive Approach

Firstly, a standard additive approach was applied to the envelope renewal, planning external insulations to be added to the façades, where possible.

The rear façade was to be equipped with a 100 mm plastered graphite EPS cladding, while a 50 mm aerogel covering should have been added to the front façade, thus reducing the façade overhang in the public area. In doing so, the opaque vertical envelope mean U-value dropped from 71 to  $0.21 \text{ W/m}^2 \cdot \text{K}$  (−70.4%), but the whole energy performance index lowered to  $166.01 \text{ kWh/m}^2 \cdot \text{yr}$  only (−17.4%, the same considering the building's carbon footprint). The large single-glazed windows played a part in that, but also the uninsulated first slab and roof (about  $1300 \text{ m}^2$  both) certainly have an important energy role in a building of only four heated floors.

Therefore, a second option was evaluated, and the previously described façade claddings were integrated with the thermal insulation of the first slab and roof, adding a 120 mm thick plastered EPS layer to the ceiling of the garage and patented 120 mm thick polyurethane foam insulating panels under the tiles in the pitched roof. All this considered, the garage ceiling U-value decreased from 1.27 to  $0.21 \text{ W/m}^2 \cdot \text{K}$  (−83.5%), while the roof U-value lowered of about the same percentage. The whole energy performance index lowered to  $105.84 \text{ kWh/m}^2 \cdot \text{yr}$  (also for the carbon footprint −47.3% with reference to the original status), without any work being carried out on the existing windows.

### 3.4.2. Passive Strategies: The Substitutive Approach

The most popular way to refurbish a glazed envelope is to replace it, because new frames paired with up-to-date glazing share a favorable price/performance ratio and a quick work schedule. Generally, anything added to existing windows will be as effective as new windows: this is why the common strategy regarding glazed envelopes cannot be anything but swapping to new windows. In the case study, the replacement of the current windows with energy-saving models ( $U$  from about 4.0 to  $1.3 \text{ W/m}^2 \cdot \text{K}$ , around  $-67.5\%$ ) was added to the abovementioned additive approach scenarios.

The new strategy on windows, if added to the “opaque envelope only” scenarios, revealed to be much more effective, obtain an energy performance index of  $75.60 \text{ kWh/m}^2 \cdot \text{yr}$  ( $-62.4\%$ , also for the carbon footprint, with reference to the original status).

### 3.4.3. Active Strategies: The Substitutive Approach

An “active” strategy is any design criteria concerning energy generation or management. In this frame, in addition to the envelope’s renewal, the heating system’s revamping should also be considered. After the building envelope is refurbished, the existing heating system can be set to work at a lower temperature to obtain the same level of inner comfort due to the consequent lower thermal loads and the heat pump implementation being very easy. The swap of the current boiler with a hybrid system, made of an air-to-water heat pump coupled with a condensing boiler, typically provides the HP the heat load in spring and autumn (75 kW max power, with low-temperature water out), while the boiler goes into operation in winter, when heat demand is at its highest. In this way, and also thanks to the renewable sources used by the HP, the case study would achieve an energy performance index of  $92.50 \text{ kWh/m}^2 \cdot \text{yr}$  ( $-54.0\%$ , also for the carbon footprint, with reference to the original status and without replacing any windows).

### 3.4.4. Active Strategies: The Additive Approach

The adoption of a hybrid system to supply the case study heating system suggests a photovoltaic implementation to power up the heat pump. A PV field of about  $220 \text{ m}^2$  and 50 kW peak power was added on the pitched roof. In this way the case study would achieve an energy performance index of  $76.75 \text{ kWh/m}^2 \cdot \text{yr}$  ( $-61.8\%$ , the same decrease for the carbon footprint, with reference to the original status and without replacing any windows).

In this type of PV installation, the main issue is how to manage summer overproduction. The case study has no centralized air conditioning system, unless the outermost layer of the façade is replaced, and a new centralized system is installed at the same time (but this is not the case). Therefore, there is no way to use the whole PV production from April to October onsite, because nowadays, the Italian onsite energy market (production vs. consumption) is limited only to what concerns the electrical needs of the condominium itself. The amount of exceeding energy is relevant, since the simulation on this case study shows a yearly overproduction of 30.1 MWh (5004 kWh in April, 5847 kWh in May, 6307 kWh in June, 6987 kWh in July, 6350 kWh in August, 4988 kWh in September and 3628 kWh in October), very useful for integration to an energy community grid.

## 3.5. Case Study Energy Performance and Historical Reference Benchmark

The results report that, in the baseline setup, the case study has its peak winter thermal load at just over 216 kW and the energy performance index ( $EPI_{gl,nren}$ ) is  $201.04 \text{ kWh/m}^2 \cdot \text{yr}$ . It is not particularly bad in Northern Italy, considering the form factor and the building period: this matches the average performance of the so-called “Legge 10/91” buildings (i.e., those built in the 1990s; see Table 12). Anyway, the case study heating service triggers a yearly carbon footprint of 110 tons of  $\text{CO}_2$ .

The comparison of the results obtained with benchmarks, acquired from aggregated historical data provided by the scientific literature, shows that it is possible to achieve a significant improvement in the energy performance of postwar buildings, bringing them

closer to benchmarks comparable to recently built housings designed in compliance with the most recent regulatory provisions.

**Table 12.** Average energy performance for heating of buildings over the last 50 years in Italy. Adapted from [30].

Average Energy Performance for Building Heating over the Last 50 Years in Italy						
Years of Construction or Typology	Before 1976 (no energy regulation)	Years 1976–1991 (Act No. 373/76)	Years 1976–1991 (Act No. 10/91)	After 2006 (Act No. 311/06)	Low-energy buildings	Nearly zero-energy buildings (NZEB)
Energy Performance Index (EPI <sub>gl,nren</sub> )	400 kWh/m <sup>2</sup> ·yr	300 kWh/m <sup>2</sup> ·yr	200 kWh/m <sup>2</sup> ·yr	100 kWh/m <sup>2</sup> ·yr	50–60 kWh/m <sup>2</sup> ·yr	≤15 kWh/m <sup>2</sup> ·yr

### 3.6. Ecological Footprint Assessment and Anthropogenic Impact

As already stated, building energy efficiency is increasingly recognized as the most effective way to reduce CO<sub>2</sub> emissions and fossil source consumption, which are topics closely linked to climate change. Hence, the retrofitting scenarios were evaluated not only considering the savings in energy need that can be achieved but also in terms of natural gas consumption and CO<sub>2</sub> abatement potential, which can be assumed, among many others, as some of the most representative indicators of the anthropogenic impact of a building on the environment. The calculation was carried out using the software “Edilclima EC700”. Table 13 and Figures 8–11 synthesize the results obtained and correlate the energy performance of the building of each scenario to indicators of anthropogenic impact.

**Table 13.** Case study of yearly energy performance, power demand, and carbon footprint for each scenario.

Scenario	EPI <sub>gl,nren</sub> kWh/m <sup>2</sup> ·yr	Annual Gas Consumption		Annual Electric Consumption		Global Carbon Footprint
		Nm <sup>3</sup> /yr	kg CO <sub>2</sub> /yr	kWh/yr	kg CO <sub>2</sub> /yr	kg CO <sub>2</sub> /yr
0	201.04	51,233	106,943	11,741	5401	112,344
1	105.84	25,970	54,210	11,426	5256	59,466
2	75.60	17,953	37,475	11,364	5227	42,702
3	68.64	11,522	24,051	35,895	16,512	40,563
4	39.23	2553	5329	42,087	19,360	24,689
5	23.51	2553	5329	19,749	9084	14,413

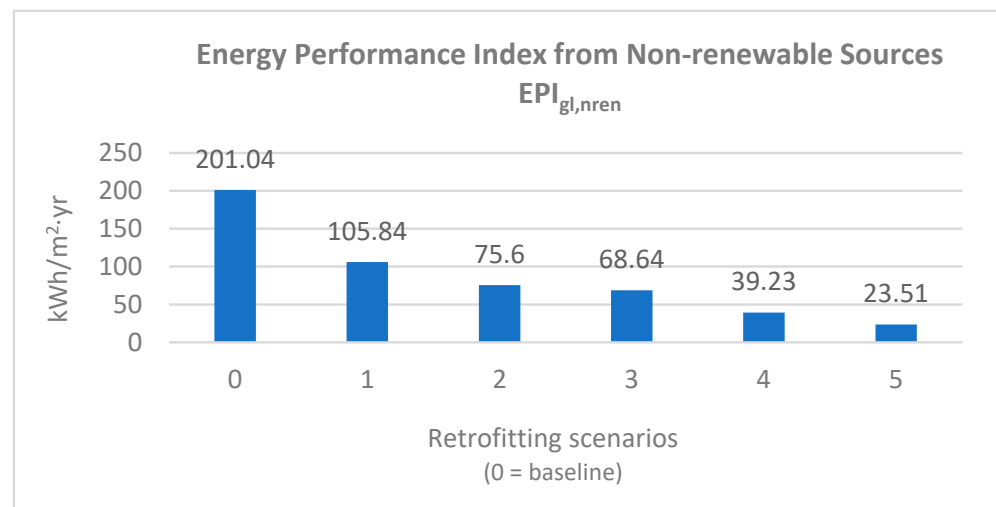

**Figure 8.** Energy performance indexes of the case study according to the different scenarios.

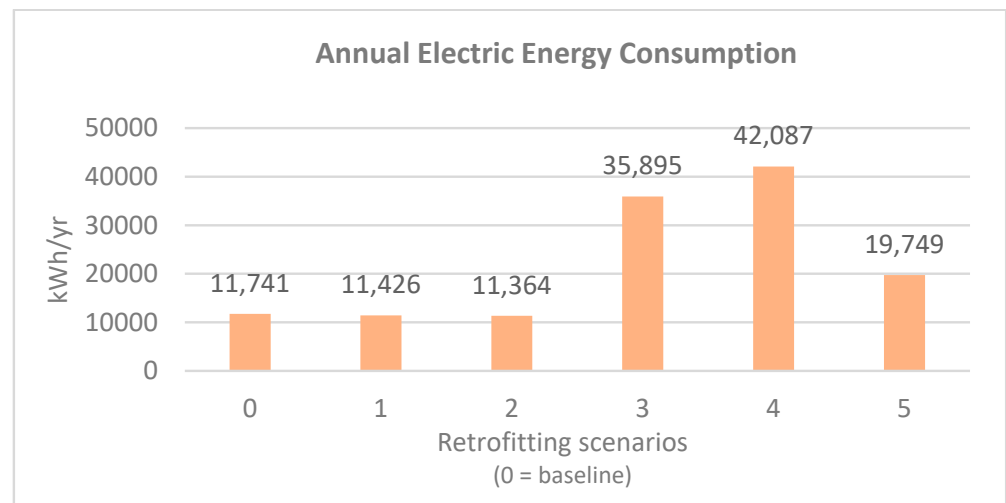

**Figure 9.** Case study electric need according to the different scenarios.

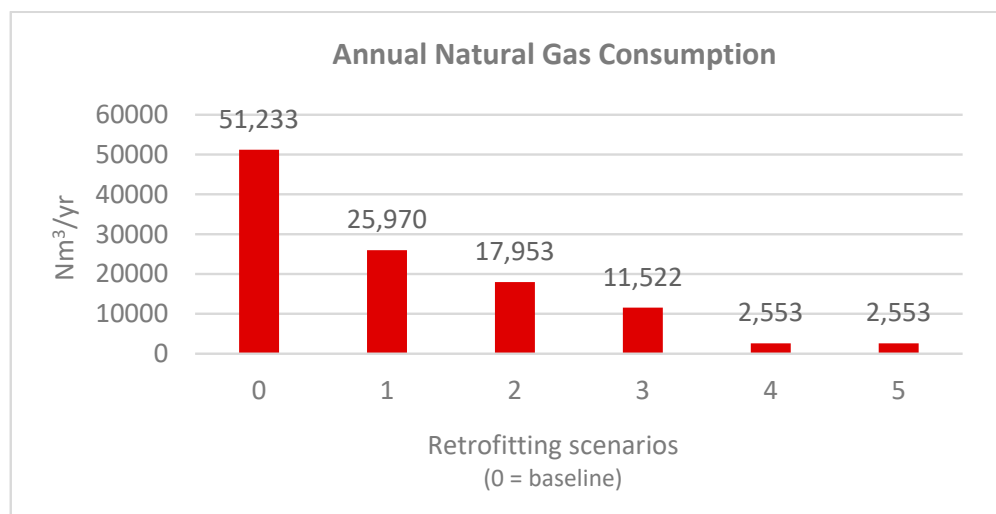

**Figure 10.** Case study gas consumption according to the different scenarios.

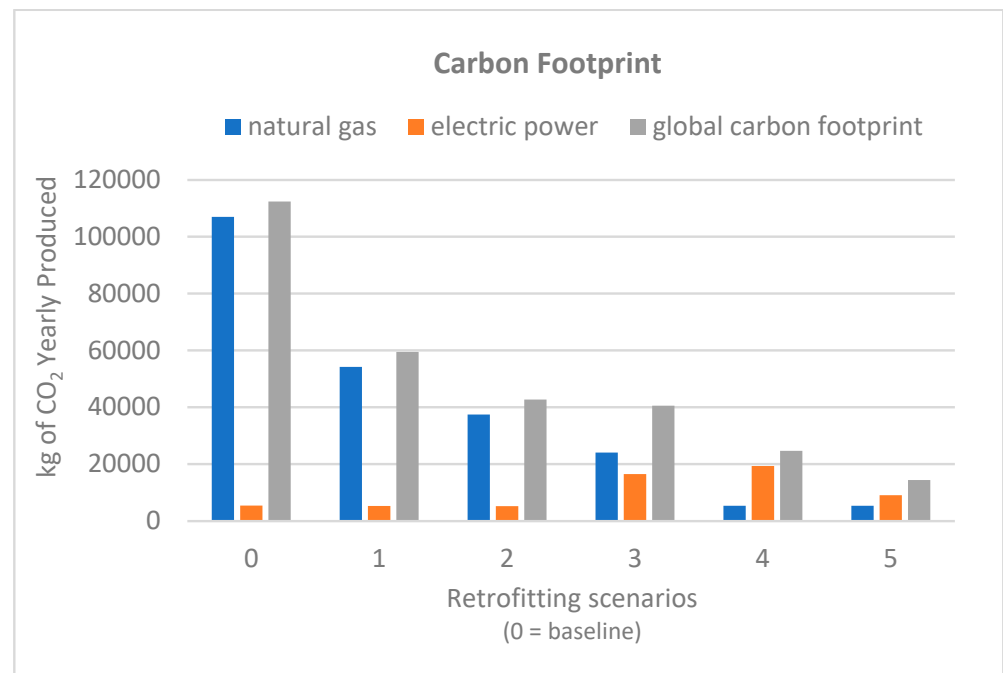

**Figure 11.** Case study carbon footprint according to the different scenarios.

The data provided show that the retrofitting scenarios, belonging to common practice, that have been assumed can drastically reduce the needs of nonrenewable, fossil sources such as natural gas. This dramatically decreases the global carbon footprint of the building. Otherwise, the electric power demand rises proportionally. In scenario 5, the electric power demand is mitigated thanks to the installation of a photovoltaic plant on the roof of the building. The results suggest that retrofitting interventions based on energy-saving or nonrenewable energy production are not sufficient to balance the metabolism of the buildings themselves. This aspect becomes even more crucial if we consider the progressive electrification of services in progress. An old building, using commonly practiced retrofitting measures, can hardly become self-sufficient or achieve environmental neutrality. This consideration drives reflection towards the study of new management models for the use and consumption of energy that, from the passage of energy management from an architectural (the building) to urban scale, allow for the achievement of greater efficiency within a systemic framework.

### 3.7. A Positive Model for the Energy Management

Although the achievement of energy savings is always desirable from an environmental and ethical point of view, it cannot be separated from a careful economic evaluation of the investments in terms of extra costs related to the interventions to be implemented, and it is necessary to attribute economic value to achievable energy savings. The literature presents some studies [31] in which, starting from models referable to building types characterized by different form factors ( $S/V$ ), simulations were conducted to determine the variation of a building's energy needs in the face of applied retrofitting interventions to the envelope, in order to compare the extra costs with the energy savings obtained. The hypothesized interventions consisted of increasing the insulation of walls, roofs, and bases and replacing windows.

The studies showed that the form factor of buildings ( $S/V$ ), a geometric parameter that identifies the type of building and the related heat exchanges, significantly affects the extra costs compared to the energy advantage obtained. Furthermore, the extra costs necessary to reach demand values lower than  $70 \text{ kWh/m}^2$  per year strongly depend on the form factor and, consequently, the smaller the building, the more exponentially the extra costs increase with the  $S/V$  ratio increase.

These limits can be overcome by aggregating building organisms into a larger energy community. Think, for example, of the case in which the useful surfaces of the building for the installation of photovoltaic solar panels are not sufficient. Then, it would be possible to obtain the energy produced using a photovoltaic field connected to the grid. Thus, the aggregation in clusters of energy-obsolete buildings represents the opportunity to overcome their most binding technological limits. Integrated energy systems of prosumers/consumers can help in refurbishing the old building stock, providing it with a clean, affordable, resilient, reliable, equitable, and safe shared energetic setup that can achieve a positive anthropogenic impact.

In addition to the reduction in energy needs and consumption, achieved using the application of the retrofitting measures illustrated so far, the adoption of new management models, based on the sharing of resources, can mitigate the cost of the energy and cope with its collateral problems.

An ‘energy community’ (Figure 12) is a management model of energy self-production and self-consumption, often based on the exploitation of renewable energy sources, which has recently been endorsed by the European “Clean Energy Package” (European Directives UE 2018/2001 and UE 2019/944), as a measure to achieve long-term energy–environmental objectives [32].



**Figure 12.** Conceptual representation of an energy community (a neural grid connecting energy facilities, households, public services, and means of transportation). Source: authors’ elaboration.

The members of an energy community are active protagonists in the management of energy flows, as they are not just consumers but also energy producers and, therefore, they are defined as prosumers. Each prosumer, through their own energy production plant, can

consume energy at once, accumulate the excess to use it at any time, according to demand, or exchange it with other members of the community [33].

Users of an energy community make up a smart grid, which relies on interconnected devices and digital platforms. The Internet of Things (IoT) allows for the monitoring and management of the production and the distribution of energy, providing users with data about the system in real time, with the aim of reducing power peaks and imbalances due to the random nature of renewable sources.

This model achieves environmental, economic, and social benefits. Among the environmental benefits, the most valuable is the reduction in the emission of climate-altering gases into the atmosphere.

The economic advantages for a citizen, a condominium, a public body, or a company are cost reduction of the variable components of the bill (energy quota, network costs, and taxes) and the income derived from the sale of the energy produced and any tax concessions, according to incentive policies adopted in each country.

The reinvestment of the income from the sale of the energy can give rise to an ancillary economy (capable of creating new job opportunities such as, but not limited to, technical ones) that can be addressed to cope with social problems regarding promoting energy affordability and equity, energy resilience, equitable and sustainable mobility, local resources, and social projects in local communities, with the general purpose of redeveloping the sociocultural substrate.

Recent experiences carried out all over the world have demonstrated the effectiveness of energy communities. In Italy, positive examples are the Green Energy Community (GECO) in Bologna, the Energy City Hall Energy Community of Magliano Alpi in Piedmont, the Pinerolese Community near Turin, the Società Cooperativa Alto But (SECAB) in Friuli and the Puglia Active Network (PAN), the latter being a large network that is expected to cover the entire Puglia Region.

### *3.8. Achievement of Positive Anthropogenic Impact Using Energy Communities*

Generally, buildings do not achieve energy self-sufficiency on their own. NZEBs also need external energy supplies, albeit limited. Traditional post-war buildings, on the other hand, are far from self-sufficient and thus have a high environmental impact, mainly due to outdated HVAC systems and poor thermal insulation.

Therefore, a single post-war retrofitted building can join an energy community taking part in a systemic metabolism that can balance and allocate resources according to demand, reducing inefficiency and waste. This symbiotic management model, encouraging energy production and consumption model change, can lead to a positive anthropogenic impact on the environment. Thus, retrofitted interventions should be implemented using the adoption of energy management models based on the sharing of energy resources, shifting from a particular and narrow view to a global one.

However, new policies that favor the sharing economy and an energetic mix of renewable sources are required. Scale interventions, addressing parts of the building stock such as groups of buildings or even small neighborhoods, should substitute uncoordinated and nonconcerted measures. This is even more crucial in the underperforming postwar building stock.

To make the building stock more energy efficient and insert it into the mutual energy exchange grid, the following guidelines should apply:

1. Energy demand and supply analysis: estimation of energy needs and examination of supply options (both contractual and technical aspects should be considered). The objective is to identify critical issues and actions to be taken to optimize the building's energy setup;
2. Prosumer energy structure evaluation, assessing both the energy and anthropogenic impact (e.g., carbon footprint);
3. Energy prosumer's reorganization, if necessary, to optimize the energy setup;

4. Growing energy communities: each territorial player is eventually aggregated into an energy management system (EnMS) according to the standards in place to join its energy community;
5. Defining the objectives of the energy management system and coordinating them.

The path defined using these guidelines is not meant to be a linear path, but as an iterative “remake and improve” circular trail to be implemented in the design and management phases.

#### 4. Conclusions and Discussion

In order to make up for the share of primary energy required for the functioning of a postwar building, it would perhaps be necessary to overcome the very consistency of the architectural artifact. This is even more evident when there are considerable geometric, technological, and technical constraints.

On the other hand, fully replacing the opaque building envelope, as in the case of “Black One” project, seems to be the most uncommon way to revamp them: and this is adequate to the “energy-saving only” tactic, generally adopted by law to compare refurbishing strategies. It probably is time to go further, considering the sustainability goal within a systemic approach that also includes the expected service life. Sparing energy is a key point, but the authors believe sparing obsolescence is another pivot, feeding the debate between “retrofitting vs. demolition and rebuilding”, because obsolescence causes unused buildings and then giant amounts of rubble from ghost edifice demolition, squandering their embedded energy or recycling management activities, which require further energy supply.

Considering façade revamping, the complete or partial (i.e., external layers only) building envelope substitution opens the design process to updated criteria, such as a new network strategy for building systems (e.g., a heating system can be turned into an energy-metered HVAC system with a new pipe network; sensors can be added to improve the HVAC management; and so on). Such types of works also have huge potential in terms of building image and up-to-date grid-connections, renewable energy technology integration, and solar shading control, even adopting greenery systems to take advantage of “free” benefits such as carbon dioxide absorption, cooling using evapotranspiration, and other biomimetic strategies.

This kind of multi-benefit approach (functional, performance, imagery etc.) has already consolidated in various research fields, also regarding existing façade over-cladding (overlapping) and recladding (replacement), as in the case of old ventilated façades.

In the common practice, the envelope upgrade strategy is often based on an additive approach, but if we consider the further benefits due to enhanced functionalities and updated image, the substitutive approach cannot be neglected, also because it helps system revamping through PV-powered centralized cooling system implementation (more efficient than individual A/C split systems, also considering the whole-life building CO<sub>2</sub> footprint). Whereas the additive approach can be only applied, and a PV-supplied heat pump adopted, a nonnegligible PV overproduction issue rises, even if masked by a less impactful construction site and immediate carbon footprint balance.

In Italy, PV overproduction is usually handed over to the national power system for free. The feasibility of an energy community (a large district, a small cluster of buildings, or even just a single condominium) energy system would be a great opportunity to locally balance prosumption and consumption of green power. This can be achieved by using modern smart metering: those who need power, e.g., for an air-conditioning system could appreciate the option to comply to the local power market, and those who are producing green energy in excess will be gratified to sell it instead of giving it away for free.

Each 100 m<sup>2</sup> flat energy meter counts about 2500 ÷ 3500 kWh/yr [34] depending on the kind of A/C system (centralized or individual system), with units having an individual air-conditioning system showing a monthly increase of 350 ÷ 400 kWh in the case of A/C use in July and August and about 150 kWh in June and September.

If we consider an overproduction of  $10 \div 15$  MWh/yr each  $100 \text{ m}^2$  of PV, the peer-to-peer energy market (condominium or district based) is a promising business model for the near future and will improve the sustainability of each district.

The energy model of a society draws its shape and support from its social and cultural model. Every change of one depends on the change of the other. Therefore, the change is characterized as a technological and social transition. As consequence, the time required for this process cannot be short. However, it may be faster in some sectors, such as transport and communications, and slower in other sectors, depending on the persistence and complexity of economic, social, and technical situations.

The planning and programming of energy transition policies have the responsibility of not causing irreversible situations, in relation to the considerable permanence of the measures undertaken and the difficulty of implementing corrective actions that could be effective in a short time.

Construction is an important sector in the economic–productive basket of each country but it is also the sector in which the characteristic temperatures of final uses are among the lowest (all below  $100 \text{ }^\circ\text{C}$ ). Therefore, this sector is suitable for the replacement of fossil fuels with both solar energy or the integration of cogeneration plants (electricity or other processes) into thermal networks.

The primary energy that is absorbed by the existing building stock exceeds, in order of magnitude, the energy that can be saved through the construction of new buildings. Therefore, it is necessary to assign priority to the energy retrofitting of the existing building stock using passive or solar active technologies or, in any case, by interventions energetically coherent with contextual situations.

The energy communities model represents an effective solution, thanks to the involvement of specific types of existing buildings (residential, schools, hospitals, office buildings, industrial buildings, etc.) and other collective services, in which the functioning timetable or the characteristics of the energy demand model can simplify or reduce the terms of complexity. The integration of processes offers the advantage of temporal continuity of energy demand, significantly reducing the time of economic return on investments [35].

The results that were obtained in this work demonstrate that, although it is possible to achieve an overall performance improvement of a postwar building from the point of view of its energy needs, it is difficult to achieve complete energy self-sufficiency.

The general set of ideas and beliefs of a historical period is formed and consolidated around multiple factors that are independent by origin, but mutually influencing. Our era can be considered revolutionary without revolutions. Without a rebellion or a collective movement led by an ideal or ideology, humanity is profoundly changing its anthropology. From simply “human” beings, endowed with a body and reasoning that makes us act, we are rapidly transforming ourselves into beings endowed with an “extended identity” that goes beyond our body and our thinking—a *dochumanity* [36]. In other words, a new expression of the human race evaluated, profiled, interpreted, and finally sold as a product of ratification. Our voluntary action is forever transformed and, in any case, is an automatic production of data that represent a source of wealth for those who possess them.

From this awareness, a new conscience must be born. As inhabitants of a house, a neighborhood, and a city, we are consumers, but equally, as explained in the paper, we can be producers of energy in solidarity and as such become responsible for a new status of “active citizenship” for the environment and for a new, virtuous circular economy concept. This is the only way to reduce the anthropogenic impact of the buildings in which we live.

**Author Contributions:** Research coordination: P.P.; Conceptualization: P.P., A.V. and R.F.; Formal analysis: M.S. and L.S.V.; Investigation: A.V., M.S. and L.S.V.; Methodology: C.L.O. and V.M.; Supervision: P.P. and C.L.O.; Validation: A.V. and P.P.; Writing, review and editing: L.S.V., A.V., P.P., C.L.O. and M.S. All authors have read and agreed to the published version of the manuscript.

**Funding:** This research received no external funding.

**Institutional Review Board Statement:** Not applicable.

**Informed Consent Statement:** Not applicable.

**Data Availability Statement:** Not applicable.

**Acknowledgments:** M. Sc. Eng. Alessia Ricco (Studio Surra).

**Conflicts of Interest:** The authors declare no conflict of interest.

## References

1. Ecorys. *Resource Efficiency in the Building Sector. Final Report*; Ecorys: Rotterdam, The Netherlands, 2014. Available online: <https://ec.europa.eu/environment/eussd/pdf/Resource/efficiency/in/the/building/sector.pdf> (accessed on 5 September 2021).
2. United Nations Environment Programme. *2020 Global Status Report for Buildings and Construction: Towards a Zero-Emission, Efficient and Resilient Buildings and Construction Sector*; UNEP: Nairobi, Kenya, 2020. Available online: <https://globalabc.org/news/launched-2020-global-status-report-buildings-and-construction> (accessed on 5 September 2021).
3. United Nations Environment Programme. *Global Status Report 2016. Towards Zero-Emission, Efficient and Resilient Buildings*; UNEP: Nairobi, Kenya, 2020. Available online: <http://globalabc.org/resources/publications/gabc-global-status-report-2016-towards-zero-emission-efficient-and-resilient> (accessed on 5 September 2021).
4. Birmingham Energy Institute. *Doing Cold Smarter*; University of Birmingham: Birmingham, UK, 2015. Available online: <https://www.birmingham.ac.uk/Documents/college-eps/energy/policy/Doing-Cold-Smarter-Report.pdf> (accessed on 30 September 2021).
5. Carletti, C.; Cellai, G.; Raffellini, G.; Scurpi, F.; Secchi, S. *Sulle Prestazioni del Sistema Edificio-Impianto: Dagli Edifici Tradizionali a Quelli "Passivi" in Proceedings of ClimaMed'04*; APIRAC: Lisbon, Portugal, 2004. Available online: [https://flore.unifi.it/retrieve/handle/2158/12180/302259/climamed\\_Raffellini.pdf](https://flore.unifi.it/retrieve/handle/2158/12180/302259/climamed_Raffellini.pdf) (accessed on 6 October 2021).
6. Fourastié, J. *Les Trente Glorieuses, ou la Révolution Invisible de 1946 à 1975*; Fayard: Paris, France, 1979.
7. Sapelli, G. *L'Italia Inafferrabile. Conflitti, Sviluppo, Dissociazione Dagli Anni Cinquanta ad Oggi*; Marsilio: Venice, Italy, 1989.
8. Verdelli, M. *Il Piano INA-Casa. Un Programma di Ricostruzione Fisica, Economica e Sociale Nell'Italia Degli Anni '50. Approfondimento sul Caso Studio Della Falchera di Torino*; Politecnico di Milano: Milan, Italy, 2009. Available online: [https://www.academia.edu/6640593/Il\\_Piano\\_INA\\_Casa\\_Un\\_programma\\_di\\_ricostruzione\\_fisica\\_economica\\_e\\_sociale\\_nellItalia\\_degli\\_anni\\_50\\_Approfondimento\\_sul\\_caso\\_studio\\_della\\_Falchera\\_di\\_Torino\\_2009\\_](https://www.academia.edu/6640593/Il_Piano_INA_Casa_Un_programma_di_ricostruzione_fisica_economica_e_sociale_nellItalia_degli_anni_50_Approfondimento_sul_caso_studio_della_Falchera_di_Torino_2009_) (accessed on 20 October 2021).
9. Cortese, A. Lo Sviluppo del Patrimonio Abitativo dal 1951 al 2011. In *Istat Working Papers*; Istituto Nazionale di Statistica: Rome, Italy, 2015; Volume 12. Available online: <https://www.istat.it/it/files/2015/06/IWP-12-2015rev.pdf> (accessed on 20 October 2021).
10. Lepratti, M. La Crisi Che Ruppe il Novecento (1973–1979). Il Racconto e i Modelli. *Historia Ludens*. 14 August 2013. Available online: <http://www.historialudens.it/geostoria-e-cittadinanza/89-la-crisi-che-ruppe-il-novecento-1973-1979-il-racconto-e-i-modelli.html> (accessed on 10 October 2021).
11. Ruzzenenti, M. Dossier "1970"—Sboccia la "Primavera Ecologica". Un Passato Che Può Essere Prologo per un Nuovo Inizio, *Altrionovecento*. 2020, Volume 43. Available online: [http://www.fondazionemicheletti.it/altrionovecento/articolo.aspx?id\\_articolo=43&tipo\\_articolo=d\\_saggi&id=415](http://www.fondazionemicheletti.it/altrionovecento/articolo.aspx?id_articolo=43&tipo_articolo=d_saggi&id=415) (accessed on 21 October 2021).
12. Nebbia, G. Dossier "1970"—La giornata della Terra, *Altrionovecento*. 2020, Volume 43. Available online: [http://www.fondazionemicheletti.it/altrionovecento/articolo.aspx?id\\_articolo=43&tipo\\_articolo=d\\_saggi&id=416](http://www.fondazionemicheletti.it/altrionovecento/articolo.aspx?id_articolo=43&tipo_articolo=d_saggi&id=416) (accessed on 21 October 2021).
13. Carson, R. *Silent Spring*; Houghton Mifflin: Boston, MA, USA, 1962.
14. Formia, E.M. Dossier "1970"—Design ed Ecologia: Punti di Contatto a Partire Dalla Mostra "Aggressività e Violenza Dell'uomo nei Confronti Dell'ambiente" (Rimini, 1970). *Altrionovecento*. 2020, Volume 43. Available online: [http://www.fondazionemicheletti.it/altrionovecento/articolo.aspx?id\\_articolo=43&tipo\\_articolo=d\\_saggi&id=419](http://www.fondazionemicheletti.it/altrionovecento/articolo.aspx?id_articolo=43&tipo_articolo=d_saggi&id=419) (accessed on 21 October 2021).
15. Meadows, D.H.; Meadows, D.L.; Randers, J.; Behrens, W.W., III. *The Limits to Growth*; Potomac Associates: New York, USA, 1972.
16. Hubbert, M. Nuclear Energy and the Fossil Fuels 'Drilling and Production Practice'. In *Spring Meeting of the Southern District. Division of Production*; American Petroleum Institute: San Antonio, TX, USA, 1956; pp. 22–27.
17. Turner, G.M. A comparison of The Limits to Growth with 30 years of reality. *Glob. Environ. Change* **2008**, *18*, 397–411. [CrossRef]
18. Ufficio Federale dello Sviluppo Territoriale (ARE). *Rapporto Brundtland 1987*, Ufficio Federale dello Sviluppo Territoriale (ARE), Bern, Switzerland. Available online: <https://www.are.admin.ch/are/it/home/media-e-pubblicazioni/pubblicazioni/sviluppo-sostenibile/brundtland-report.html> (accessed on 22 October 2021).
19. Ministero della Transizione Ecologica (MITE). *L'Agenda 21*; Ministero della Transizione Ecologica (MITE): Rome, Italy, 2017. Available online: <https://www.mite.gov.it/pagina/lagenda-21> (accessed on 22 October 2021).
20. Manzoni, F. Normative per L'efficienza Energetica Degli Edifici, ExpoClima. Available online: <https://www.expo clima.net/normative% C2% A0per-lefficienza-energetica-degli-edifici> (accessed on 23 October 2021).
21. Istituto Superiore per la Protezione e la Ricerca Ambientale (ISPRA). *Politiche sul Clima e Scenari Emissivi*; Istituto Superiore per la Protezione e la Ricerca Ambientale (ISPRA): Rome, Italy, 2021. Available online: <https://www.isprambiente.gov.it/it/attivita/cambiamenti-climatici/politiche-sul-clima-e-scenari-emissivi> (accessed on 23 October 2021).

22. European Commission. *What is Energy Poverty?* European Commission. Energy Poverty Advisory Hub (EPAH): Bruxelles, Belgium, 2021. Available online: [https://energy-poverty.ec.europa.eu/energy-poverty-observatory/what-energy-poverty\\_en](https://energy-poverty.ec.europa.eu/energy-poverty-observatory/what-energy-poverty_en) (accessed on 25 October 2021).
23. ANSA. *Eurostat. Oltre l'11% Degli Italiani in Povertà Energetica*; Ansa: Rome, Italy, 2021. Available online: [https://www.ansa.it/canale\\_ambiente/notizie/focus\\_energia/2021/11/05/eurostat-oltre-111-degli-italiani-in-poverta-energetica\\_458e85c0-b561-481c-b9c0-14c27fe5c5c0.html](https://www.ansa.it/canale_ambiente/notizie/focus_energia/2021/11/05/eurostat-oltre-111-degli-italiani-in-poverta-energetica_458e85c0-b561-481c-b9c0-14c27fe5c5c0.html) (accessed on 7 November 2021).
24. Rankin, J.; Milman, O.; Ni, V. *Global Energy Crisis: How Key Countries Are Responding*; The Guardian: London, UK, 2021. Available online: <https://www.theguardian.com/business/2021/oct/12/global-energy-crisis-how-key-countries-are-responding> (accessed on 24 October 2021).
25. McKinsey & Company. *Climate Change Special Initiative*; McKinsey & Company: New York, NY, USA, 2007.
26. Afshari, A.; Nikolopoulou, C.; Martin, M. Life-Cycle Analysis of Building Retrofits at the Urban Scale—A Case Study in United Arab Emirates. *Sustainability* **2014**, *6*, 453–473. [CrossRef]
27. The Black One. +StudioArchitetti; The Black One: Turin, Italy, 2020. Available online: <http://www.piustudio.it/portfolio/the-black-one-torino/> (accessed on 16 December 2022).
28. Google. Google Street View Turin, Italy (45.07° N, 7.65° E). 2019. Available online: <https://www.google.com/maps/place/Corso+Alessandro+Tassoni,+4/> (accessed on 16 December 2022).
29. City of Turin (Italy). Municipal Archives of Private Construction Works (public consultation).
30. Viel, M. Leggi Energetiche. 15 October 2009. Available online: <https://my.liuc.it/MatSup/2009/Y90217/egge-energetiche.pdf> (accessed on 13 November 2021).
31. Bano, L. *Economia e Regolamentazione degli Investimenti nelle Fonti Rinnovabili in Italia: Tra Vincoli Ambientali e Politiche Locali*. Ph.D. Thesis, Università degli Studi di Padova, Padua, Italy, 2006.
32. Franchino, M. *Comunità Energetiche e Cittadinanza Attiva*; Scienza in Rete. 11 July 2021. Available online: <https://www.scienzainrete.it/articolo/comunit%C3%A0-energetiche-e-cittadinanza-attiva/marianna-franchino/2021-07-11> (accessed on 24 October 2021).
33. Agenzia Nazionale per le Nuove Tecnologie, L'energia e lo Sviluppo Economico Sostenibile. *La Comunità Energetica*, Vademecum 2021, ENEA. 2021. Available online: <https://www.enea.it/it/seguici/pubblicazioni/pdf-volumi/2021/opuscolo-comunita-energetica.pdf> (accessed on 24 October 2021).
34. Autorità di Regolazione Energia Reti e Ambiente (ARERA). *Dati e Documenti*; Autorità di Regolazione Energia Reti e Ambiente (ARERA): Rome, Italy, 2021. Available online: [https://www.arera.it/it/pubblicazioni/altre\\_pubblicaz.htm](https://www.arera.it/it/pubblicazioni/altre_pubblicaz.htm) (accessed on 14 November 2021).
35. First Online. *Transizione Ecologica: L'importanza Delle Comunità Energetiche*. First Online. 14 November 2021. Available online: <https://www.firstonline.info/transizione-ecologica-limportanza-delle-comunita-energetiche/> (accessed on 15 November 2021).
36. Ferraris, M. *Documanità. Filosofia del Mondo Nuovo*; Laterza Editore: Bari, Italy, 2021.

**Disclaimer/Publisher's Note:** The statements, opinions and data contained in all publications are solely those of the individual author(s) and contributor(s) and not of MDPI and/or the editor(s). MDPI and/or the editor(s) disclaim responsibility for any injury to people or property resulting from any ideas, methods, instructions or products referred to in the content.