

Advanced European Re-Entry System Based on Inflatable Heat Shields
EFESTO project overview: preliminary IOD mission and system definition

Original

Advanced European Re-Entry System Based on Inflatable Heat Shields
EFESTO project overview: preliminary IOD mission and system definition / Governale, Giuseppe. - (2022). (International Astronautical Congress (IAC 2022) Paris, France 18-22 September 2022).

Availability:

This version is available at: 11583/2972219 since: 2022-10-11T11:34:15Z

Publisher:

International Astronautical Federation (IAF)

Published

DOI:

Terms of use:

This article is made available under terms and conditions as specified in the corresponding bibliographic description in the repository

Publisher copyright

(Article begins on next page)

IAC-22-D2.6.8 (x71987)

Advanced European Re-Entry System Based on Inflatable Heat Shields EFESTO project overview: preliminary IOD mission and system definition

G. Guidotti^{a*}, F. Trovarelli^a, I. Pontijas Fuentes^a, A. Rivero Martín^a, B. Esser^b, T. Schleutker^b, I. Dietlein^c,
G. Gambacciani^d, G. Governale^e, R. Gardi^f, J.-L. Verant^g, Y. Dauvois^g, Y. Prevèreaud^g

^a DEIMOS Space S.L.U., Tres Cantos, Spain

^b Deutsches Zentrum für Luft- Und Raumfahrt e.V. (DLR), Köln, Germany

^c Deutsches Zentrum für Luft- Und Raumfahrt e.V. (DLR), Bremen, Germany

^d AVIOSPACE SRL, Torino, Italy

^e Department of Mechanical and Aerospace Engineering, Politecnico di Torino, Turin – Italy

^f Centro Italiano Ricerche Aerospaziali (CIRA), Capua – Caserta, Italy

^g Office National d'Etudes et de Recherches Aerospatiales (ONERA), Toulouse, France

* Corresponding Author: giuseppe.guidotti@deimos-space.com

Abstract

The European Union H2020 EFESTO project is coordinated by DEIMOS Space with the end goals of improving the European TRL of Inflatable Heat Shields for re-entry vehicles from 3 to 4/5 and pave the way to an In-Orbit Demonstration (IOD) that can further raise the TRL to 6. This paper provides a synthesis of the EFESTO design and experimental achievements and sums up the Inflatable Heatshield IOD mission and system design which is the final step of the EFESTO project. First, the initial IOD design resulted from a dedicated concurrent engineering analysis is introduced. The session core consisted of trading-off on the system configuration options derived from the sequential design and testing campaigns, including the Inflatable Structure (IS) and Flexible Thermal Protection Systems (F-TPS) key subsystems, but also on additional aspects such as launcher and landing site selection. The driving rationale here corresponded to the maximization of the scientific return of the experiment while also taking into account feasibility considerations related to the current European Space Sector capabilities and market opportunities. The subsequent design phase focused instead on harmonizing and the mission and system definition and extending it with a preliminary assessment of the IOD system realization and mission implementation. This final output represents a unique contribution of the EFESTO project to the European know-how in inflatable heatshield technology and promotes the relevance of the EFESTO Consortium in the frame of a European re-entry technology roadmap.

Keywords: Re-entry system IOD, Reusability, Mars Exploration, EDL, Flexible-TPS, Inflatable Structure, Aerodynamic Decelerators.

1. Introduction

EFESTO is a project funded by the European Union H2020 program aiming for a revamp and growth of European know-how and systems engineering capabilities in the strategic field of Inflatable Heat Shield technology (IHS) for re-entry vehicles [1] to [5].

The project was carried out by a European consortium led by Deimos Space (ES) which also includes CIRA (IT), ONERA (FR), DLR (DE), Aviospace (IT), and Politecnico di Torino (IT).

The team also leveraged the valuable external support of Thin-Red-Line Aerospace (CA) and ALI Aerospace Laboratory for Innovation (IT) [5].

EFESTO project hints were: (1) identification of mission classes enabled by the use of advanced Inflatable Heat Shields (IHS); (2) definition of meaningful case study scenarios for both Earth and Mars re-entry applications; (3) execution of mission and system design loops for obtaining the operative environment to properly feed the

engineering of the IHS key components (i.e., Flexible Thermal Protection System, **F-TPS**, and Inflatable Structure, **IS**); (4) verification of both the F-TPS and the IS design solutions through manufacturing of breadboards and testing in relevant environment (respectively, F-TPS lay-ups in high-enthalpy arc-jet facility in both Earth and Martian atmospheres, and an IS demonstrator via a dedicated vacuum test-rig); (5) conceptual design of an In-Orbit Demonstration (**IOD**) mission for future flight testing and verification of the matured IHS technologies.

2. IOD Needs and objectives

Based on EFESTO technical and technological achievements [1] to [3], once assessed the gap with respect to the state-of-art, the necessary advances an IOD mission could bring into the TRL increase were identified. This allowed then to define a set of high-level

requirements to be fulfilled by a possible EFESTO IOD initiative as hereunder listed:

- it shall allow to increase the TRL in the range 6÷7;
- it shall be designed around the Earth scenario since a flight test through Earth atmosphere would not allow an equivalence w.r.t. re-entry into the Mars atmosphere;
- it shall allow coupling of critical aspects of IHS systems: aerodynamics, structural, thermal and aerothermal, etc
- it shall allow the system to experience an environment as closest as possible to the one used for the design and replicated during tests in order to allow models validation/verification, cross-correlation between ground testing (both arcjet and structural) and flight testing;
- it shall be executed by a system featuring key functions and architectural/configurational aspects similar to those of the Earth Scenario in order to exploit as much as possible heritage and confidence levels matured with the design and modelling, and manufacturing;

Afterwards, two key activities were started: identification of launch vehicles options (LV), and definition of a ConOps.

The outcomes are hereunder reported.

2.1 Launcher trade-off and selection

Initially, three different LVs classes were taken into account for IOD mission implementation, with increasing complexity and effort. However, both heavy launchers and sounding rockets were afterwards discarded due to high complexity and cost for the former; and low volume/mass performance and non replicability of the aerothermal environment for the latter. Hence small launchers were retained as the best alternatives.

Many small LV options were considered (Fig.1, Fig.2) in a trade-off executed considering key evaluation criteria as volume fairing, P/L capability, operational aspects, cost, and strategic aspects.

The best promising solutions identified were the RFA launcher “One” (GER) and the ISAR launcher “Spectrum” (GER). (Fig.3)

2.2 IOD CONOPS and entry-corridor design

The mission baseline, as presented in Fig.4 and Fig.5, starts with the vehicle being launched on board a dedicated small launcher (1), delivered to suborbital path (2) up to Entry Interface Point; at this point the inflatable heatshield gets inflated before re-entry (3) for protecting the payload during the hypersonic entry phase; at the end of re-entry (4) a decelerator slows down the vehicle for a successful splashdown in the Atlantic Ocean, where it gets recovered and brought back to a post-flight investigation facility (5).

Alternative	Launcher	Provider	Country
A1	Alpha	Firefly Aerospace	USA
A2	Terran 1	Relativity Space	USA
A3	One	Rocket Factory Augsburg	Ger (EU)
A4	Spectrum	Isar Aerospace	Ger (EU)

Fig. 1: small LV alternatives.

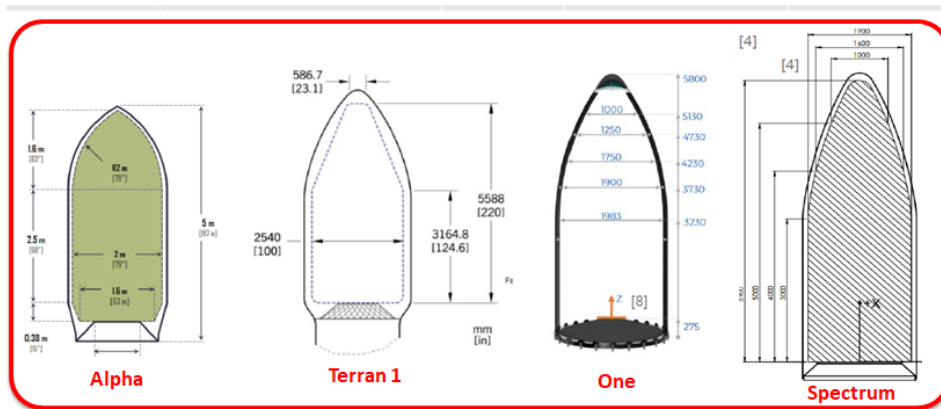

Fig. 2: LV alternatives – P/L envelope.

				A1	A2	A3	A4
	Mission	Weight abs (1 to 5)	Weight rel	Alpha	Terran-1	One	Spectrum
C1	Volume fairing	5	28%	2.61905	4.47619	4.52381	3.7619
C2	PL capability	4	22%	2.5	4	5	3
C3	Operation aspects	4	22%	4.14286	4.14286	5	5
C4	Cost	3	17%	2	3	4.5	3
C5	Strategic aspects	2	11%	3	3.18182	3.72727	3.54545
		18	100%	2.87037	3.90645	4.64298	3.71669

Fig. 3: LV alternatives – trade-off.

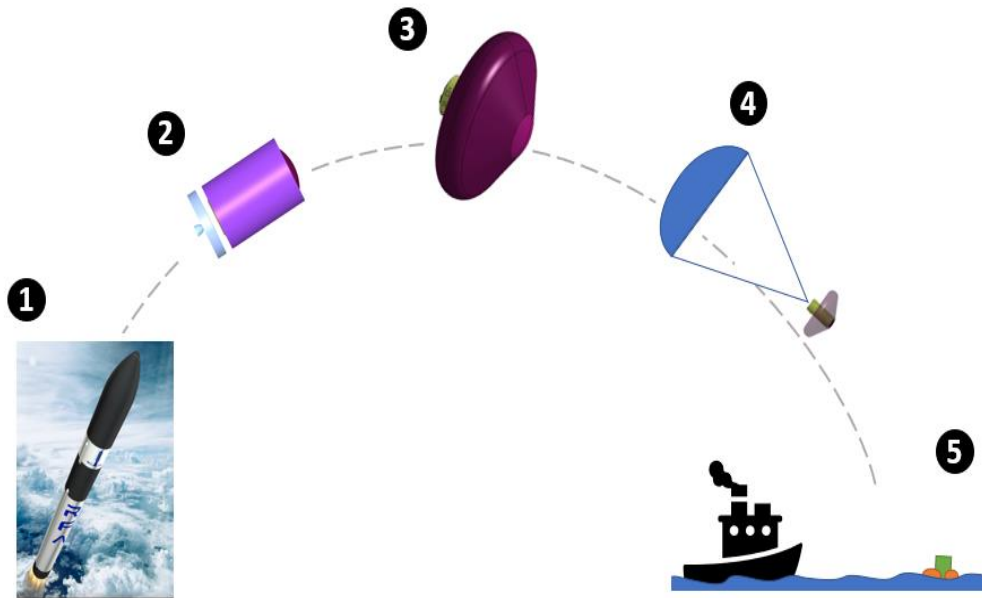

Fig. 4: EFESTO IOD ConOps.

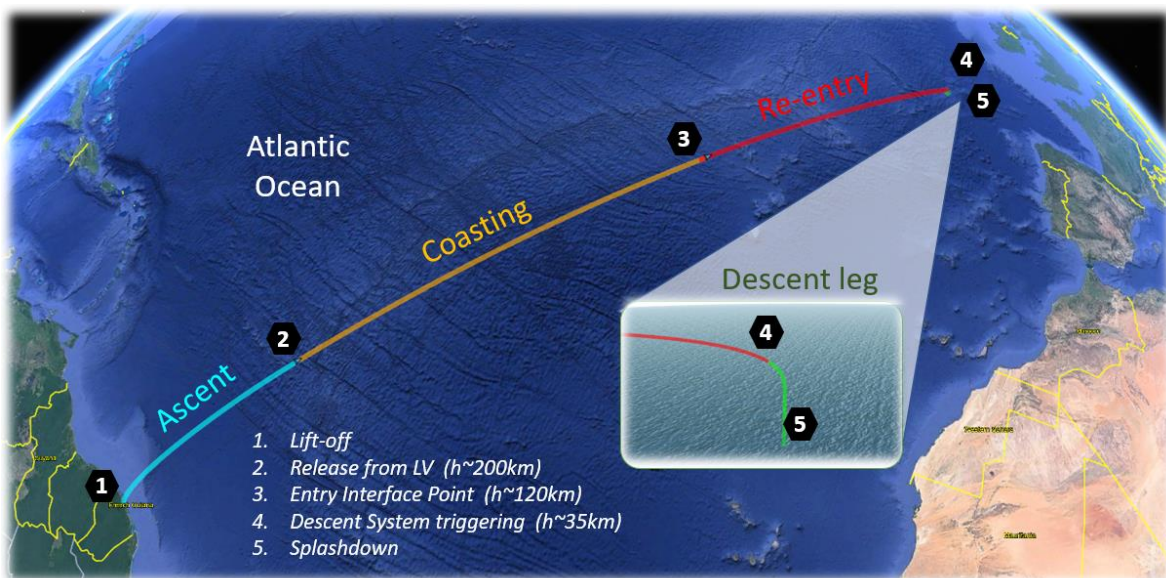

Fig. 5: EFESTO IOD end-to-end path.

3. IOD mission analysis

Two loops of Mission Analysis including 2D local entry corridor as well as the definition of the reference and sizing trajectories in terms of thermal loads have been carried out for the 1:1 scale IOD system demonstrator. The assumptions for the analyses were:

- ❑ the Entry Interface Point (EIP) arrival conditions: re-entry velocity of 7.6 km/s.
- ❑ re-entry vehicle geometry: shield diameter of 4.8 m, cone of 60°, nose radius of 1.3 m.
- ❑ aerodynamics based on EFESTO data.
- ❑ reference target mass is 1000 kg, leading to reference ballistic coefficient of approx.. 40 kg/m².
- ❑ trajectories simulated from the Entry Interface Point (EIP, 120 km above ground) down to ground, considering a ballistic entry and no parachute deployment.
- ❑ baseline landing site analysed is Santa María Airport (in Azores): 36.79°N, 25.17°W.
- ❑ max heat flux: 500kW/m²
- ❑ max het load: 42.5MJ/m²

The active constraints that define the entry corridor are: the landing accuracy on the shallow side; and the heat flux and load factor on the steep side.

A reference flight path angle of -3.1° can be selected to be centred in the corridor and to have higher margins to all the constraints.

3.1 IOD reference trajectories

The mission analysis produced the following reference trajectory in terms of: dynamics pressure, g-load, heat flux and heat load time history from entry to landing. (Fig.6 to Fig.9)

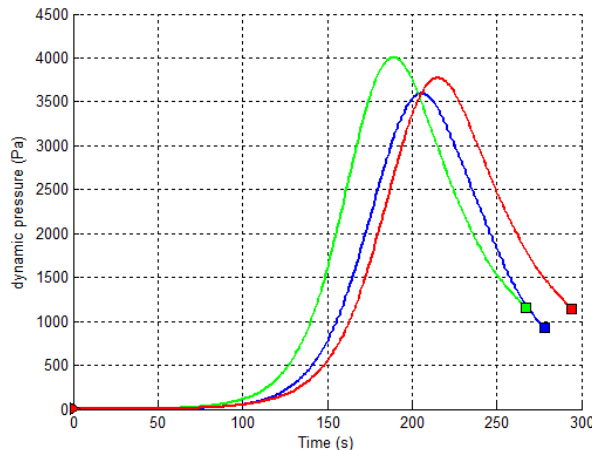

Fig. 6: IOD dynamic pressure profile.

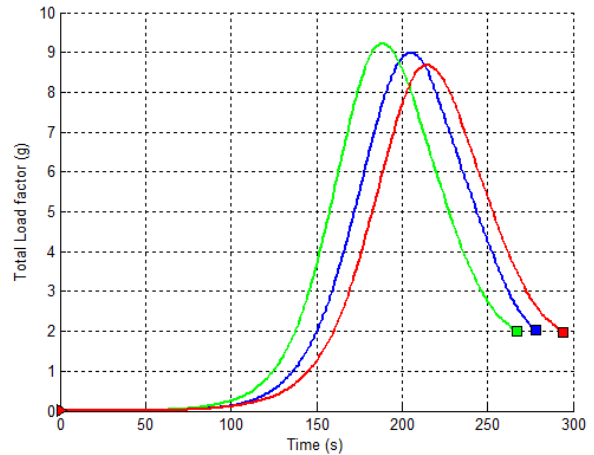

Fig. 7: IOD g-load profile.

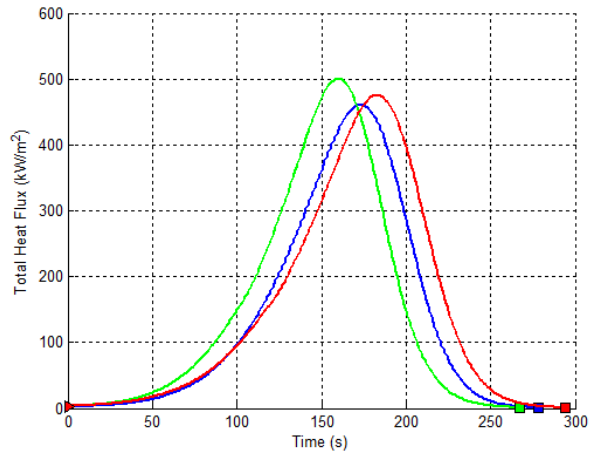

Fig. 8: IOD heat flux profile.

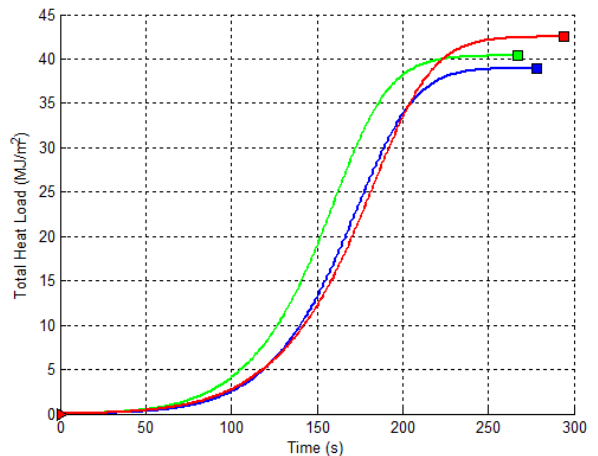

Fig. 9: IOD heat-load profile.

3.2 IOD Monte Carlo verification

A Monte Carlo campaign of 1000 shots run was executed with dispersions applied to aerodynamics, MCI properties), mission phases (initial conditions, events), Environment (atmosphere model). . (Fig.10 to Fig.12)

The objectives of the MC verification include:

- ❑ verify that the peak entry aero-thermomechanical loads are within constraints defined in Table 3 20.
- ❑ assess the need for a second stage parachute to reach terminal conditions compliant with the constraints for a successful deployment of a subsonic parachute or parafoil.
- ❑ confirm the preliminary estimation of the landing site area and assess the landing accuracy to take into account for the recovery operations.

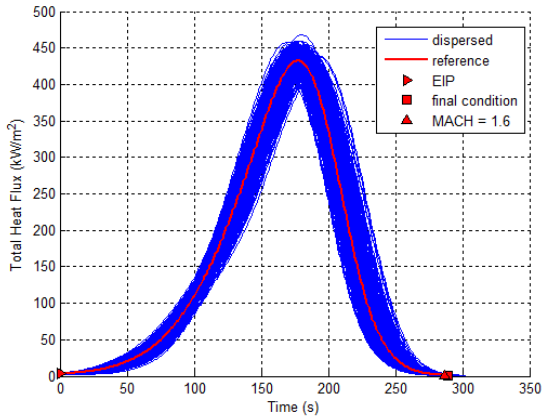

Fig. 10: IOD heat-flux dispersion.

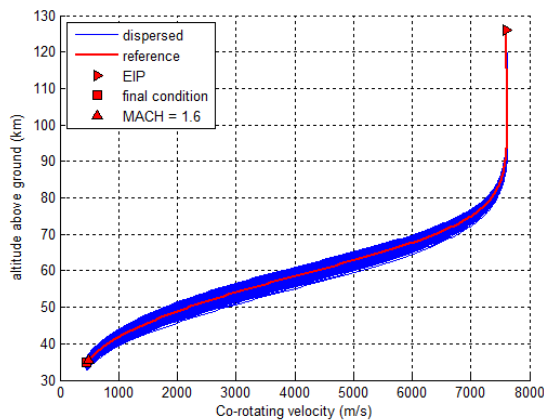

Fig. 11: IOD altitude vs velocity dispersion.

3.3 IOD recovery operations

The selected splashdown option requires that the vehicle gets recovered within the 36 hours window. The feasibility of this recovery strategy depends on the dispersion area to be covered and the number and properties of the ships available. (Fig.13))

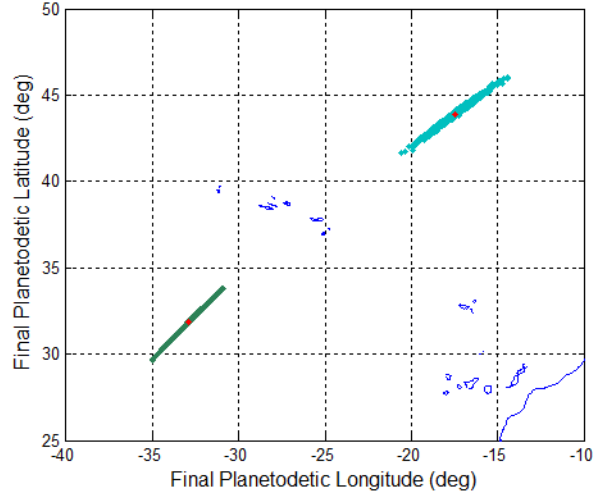

Fig. 12: IOD entry and parachute triggering dispersion (Spectrum LV orb. Inc 55° scenario).

A wide set of ships have already been used for recovery purposes. Some examples include the NRC Quest (15 knots), or the GO Searcher and GO Navigator, (22 knots) currently used by SpaceX for the Dragon capsule recovery. Assuming an average vessel speed of 15 knots, the full along-track splashdown dispersion of 310 km can be covered in approximately ~1 day. For the specific EFESTO IOD RFA launcher baseline scenario a viable solution could be to employ 2 recovery ships, eventually anchored in Faroe Islands, to further reduce to ~12 hours the recovery time.

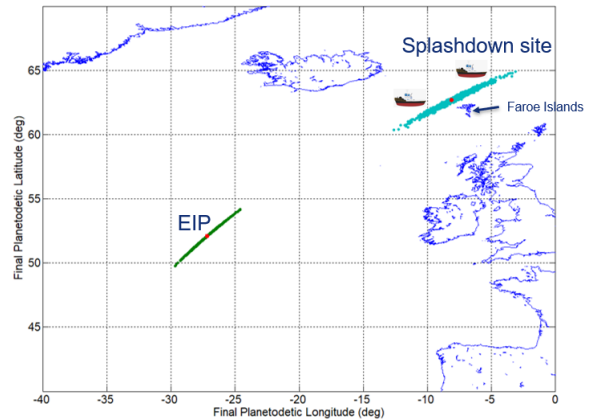

Fig. 13: Position dispersion at splashdown and recovery ships (RFA One LV scenario).

3.4 IOD visibility verification

A preliminary geometric visibility analysis (fig.14 to 16) was carried out to evaluate the existence of a line of sight between IOD re-entry vehicle and a given Ground Station (GS) including the constraints of station mask (elevation). The analyses have been performed for the baseline reference trajectory (RFA LV, inclination of 68°)

as well as for the back-up option (ISAR LV, inclinations of 68° and 55°).

A reference network of stations was considered, European and non-European. According to the results there are many ground stations near the re-entry ground

tracks of the considered IOD re-entry trajectories (baseline and back-up options, plotted respectively in black, red and light blue). Based on the results the following remarks can be given:

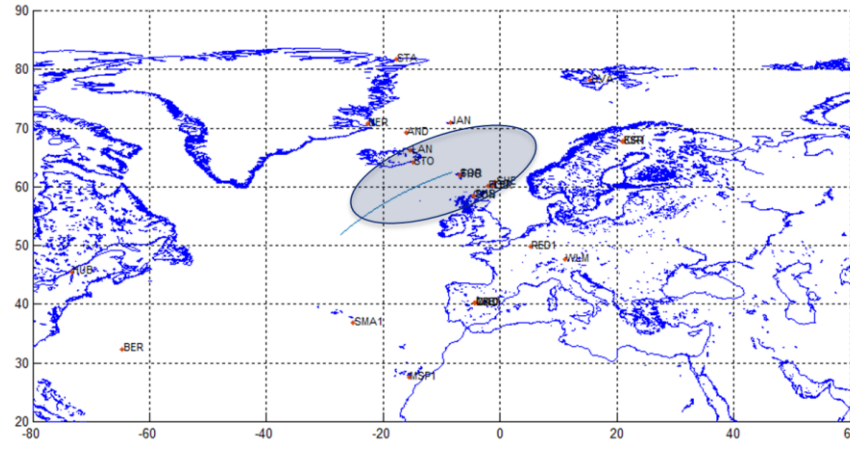

Fig. 14: Ground track respect to ground station locations, RFA LV orbit inclination of 68°.

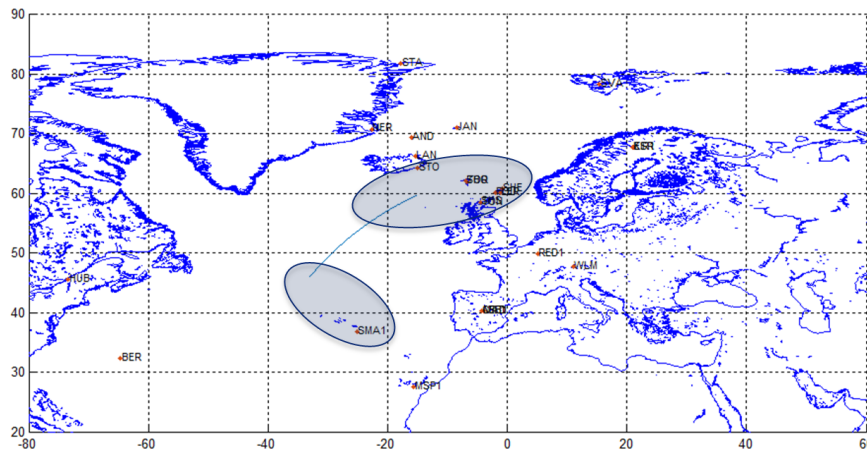

Fig. 15: Ground track respect to ground station locations, Isar LV orbit inclination of 68°.

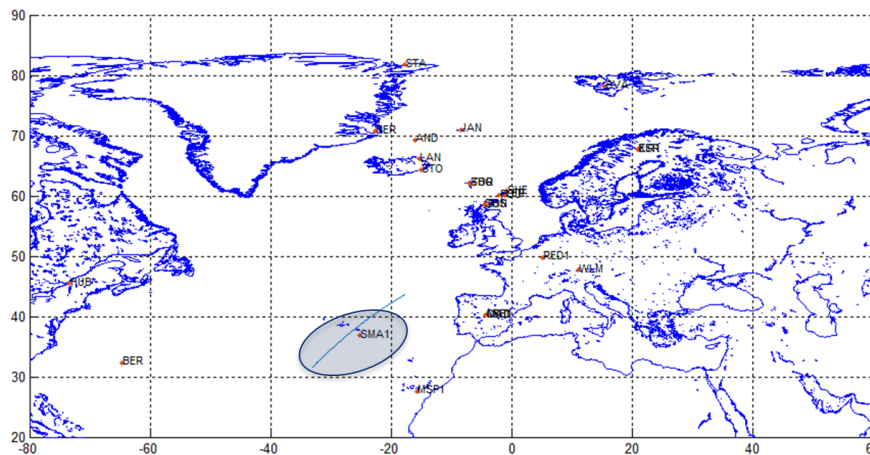

Fig. 16: Ground track respect to ground station locations, Isar LV orbit inclination of 55°.

Based on the visibility analysis outcomes the following considerations apply:

- ❑ Ground Stations considered are located in Europe, Iceland and Greenland.
- ❑ RFA LV trajectory (inc 68°): Visibility gap between 0 and 50 seconds after EIP. Most of the trajectory can be tracked from stations in the North of Europe and Iceland, e.g. from STO (Stokksnes).
- ❑ ISAR LV trajectory (inc 68°): Visibility gap between 10 and 175 seconds after EIP. EIP can be tracked from Santa Maria station and the final part of the trajectory from the North of Europe and Iceland, e.g. from STO (Stokksnes).
- ❑ ISAR LV trajectory (inc 55°): it can be tracked mostly from Santa Maria and the last 50 s can either be untracked or tracked using a support ship with a narrow antenna.
- ❑ The ISAR LV 55° solution seems to be the best one: it allows for a splashdown near Spain or Portugal, it allows for a slight greater mass at launch, it allows for a slight reduced dispersion at splashdown (305 vs. 310 km of Isar), and finally it allows a tracking from EIP down to 40km with the possibility to track the final part from the recovery boat.

4. IOD system

4.1 IOD Aeroshape definition

The IOD system baseline aero-shape is shown in the figure below (Fig.17). It features:

- a 4.8m diameter shield
- a 1.3m nose-tip radius
- 120° cone angle
- 3m full stowed length

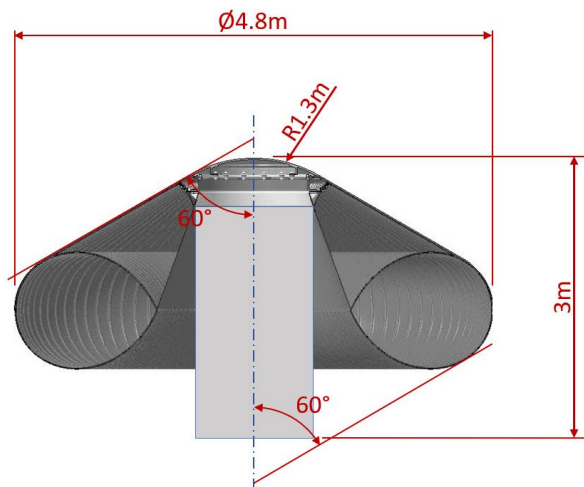

Fig. 17: IOD System aeroshape.

4.2 IOD configuration

The system features a simplified architecture with:

- the shield, embedding the integration of a Flexible TPS skirt (F-TPS) and an Inflatable Structure (IS);
- the main body, embedding a supporting cylindrical structure where all the on-board systems are supposed to be installed;

The following product list including major subsystem groups was considered:

- Inflatable Shield System
 - IS
 - F-TPS
 - Inflation system
- Rigid-TPS (nose-cone)
- Avionics
- In-flight measurement system
- Thermal management system
- Recovery system
- Descent system
- Structural parts
- Separation devices

The preliminary distribution of the on-board equipment was also addressed together with the system arrangement before launch, as represented in the Fig.18 to 19.

Concerning the shield itself, it is composed of a Flexible TPS skirt and an Inflatable Structure.

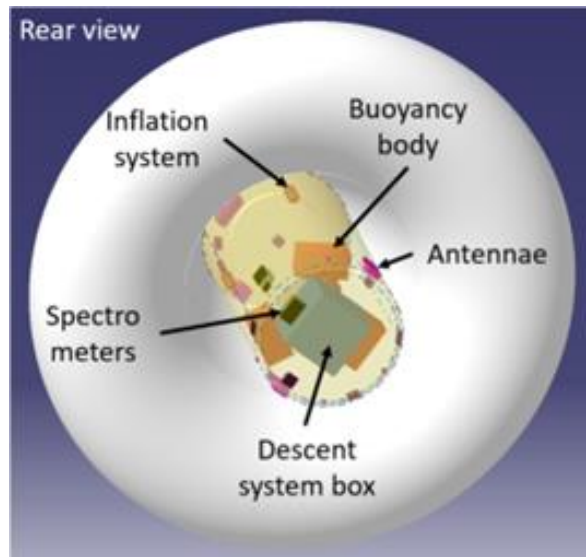

Fig. 18: IOD System internal layout.

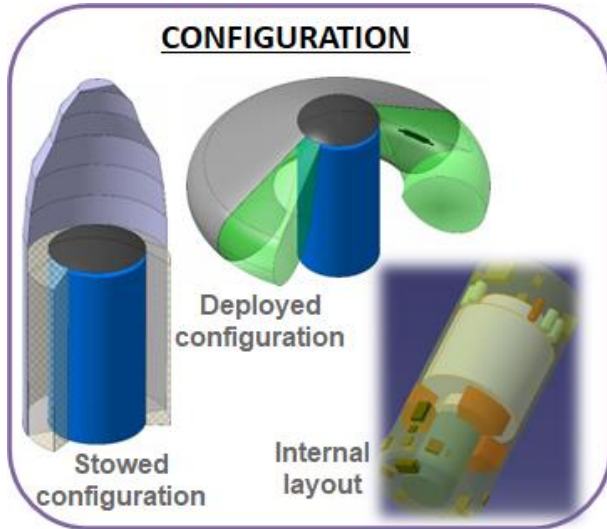

Fig. 19: IOD System stowed and deployed layout.

The IS (Fig.20) is the Dual Body (i.e. two inflatable volumes).

This configuration comprises a higher-pressure annulus that defines the diameter of the deployed IAD (the annular volume or AV), and a lower pressure conic volume (CV) that defines the IAD's deployed conic geometry. The design premise of the DB configuration mandates that the annulus defines the IAD's cross-sectional drag area while providing the structural facility to support accurate distention of the cone's frontal drag surface geometry. This type of configuration is in the prototyping heritage of the Canadian Company Thin Red Line Aerospace (TRLA) and provides a relatively simple realization with respect to the other more complex configurations analysed in previous phases of the project.

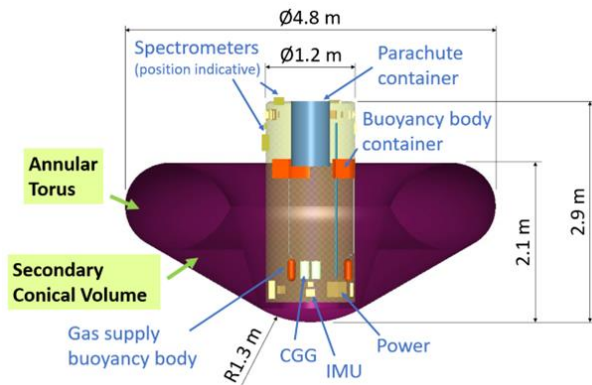

Fig. 20: IOD System IS components.

The F-TPS skirt (Fig.21) is made of different layers of materials ranging from the outer hi-performance SiC-based fabrics (Hi-Nicalon) to internal insulations layers (SigraTherm), and inner layer (Nextel). The F-TPS stack-

up has been obtained upon thermal analysis of the heat flu propagation and designed in such a way to protect the inner IS layers not to overcome the limit temperature of 300°C.

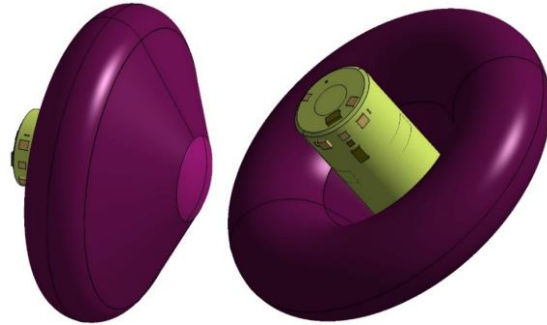

Fig. 21: IOD System F-TPS components.

The system-level work succeeded also in allocation of mass through early design and sizing, and that yielded to build the spacecraft mass budget and MCI (Fig.22).

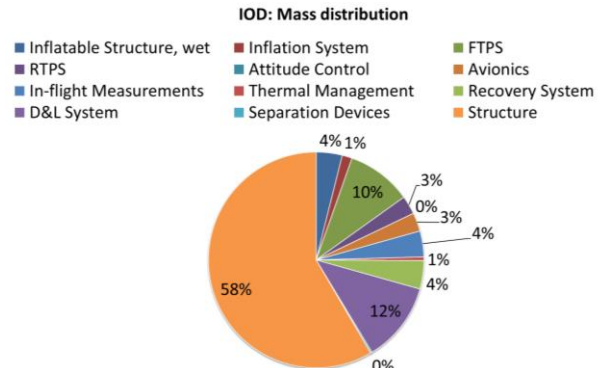

Fig. 22: IOD System mass % breakdown.

5. IOD contribution to HIAD TRL increase

The analysis of the literature allowed the EFESTO team to identify the gap with respect to most relevant experiences in the world (e.g.: the NASA IRVE legacy), therefore it remains the need for an IOD mission in order for the EFESTO technologies to be increased in TRL.

EFESTO achievements obtained so far seem to place the development status at one step prior to an “early demonstration flight”. So, the “IOD” definition for EFESTO should rather refer to an “in-flight operational demonstration” to enable testing of a full integrated system under a 3D coupling of aerodynamic, structural, pneumatic and thermal aspects.

The IOD could bring into the game the following additions:

- Verify in-flight the behaviour of an IAD system integrating F-TPS and IS, from the standpoint of deploying and inflating the aeroshell exo-atmospherically and maintaining an aero-shape during re-entry;

- allow for basic vehicle model identification (e.g.: aerodynamic, structural modes/shape deformation, pneumatic “modes”, structural loads, etc.);
- collect flight data for comparison with analysis in the frame of Computational Fluid Dynamics (CFD), Finite Elements Methods (FEM), fluid-structure interactions;
- testing re-entry survivability at meaningful heating rates;
- mature and consolidate integration solutions of an IAD w. r. t.: mechanical/pneumatic interfaces (I/F); packing/stowing, etc.

The EFESTO effort finally succeeded to assess a feasible global picture of an IOD mission to leverage on the EFESTO achievements in the field of the Inflatable Heat shields. The results can be exploited as starting point for a full-spectrum feasibility assessment and for a preliminary IOD design definition to be addressed by a future initiative.

6. EFESTO technology roadmap

To assess the technology development pushed and enabled by the EFESTO project, related missions and technologies (developed and/or under development) have been assessed with the related categorisation. It is possible to identify an increase of interest and effort in the field of hypersonic deployable decelerators and its TPS in the latest 30 years. However, before the EFESTO project there was a gap in the European effort for such technologies.

Graphically based on the 2018 global exploration roadmap [6], the EFESTO technology roadmap (Fig. 23) identifies where the project place itself with respect to other development programmes.

The EFESTO project team succeeded in:

- revamping European interest in the field of Inflatable Heat Shields
- increasing European knowledge and capability in the field at mission, system and technology level
- obtaining significant material and mechanical achievements reaching TRL 4
- defining a feasible demonstration mission

Beyond EFESTO it would be worth to:

- promote new initiatives to further mature design capabilities and progress TRL of key technologies with ground developments
- plan implementation of an in-flight verification, validation and demonstration effort to close the loop and reach higher TRL
- envisage a phase B study at European level supported by ESA, eventually in synergy with the European Commission, to develop a preliminary design definition at mission and system level

Generally, all the EFESTO development can be considered an enhancer of affordability as providing solutions more lightweight and enabling reusability, these being a principle of the sustainability, direction chosen by the space industry 4.0 [7].

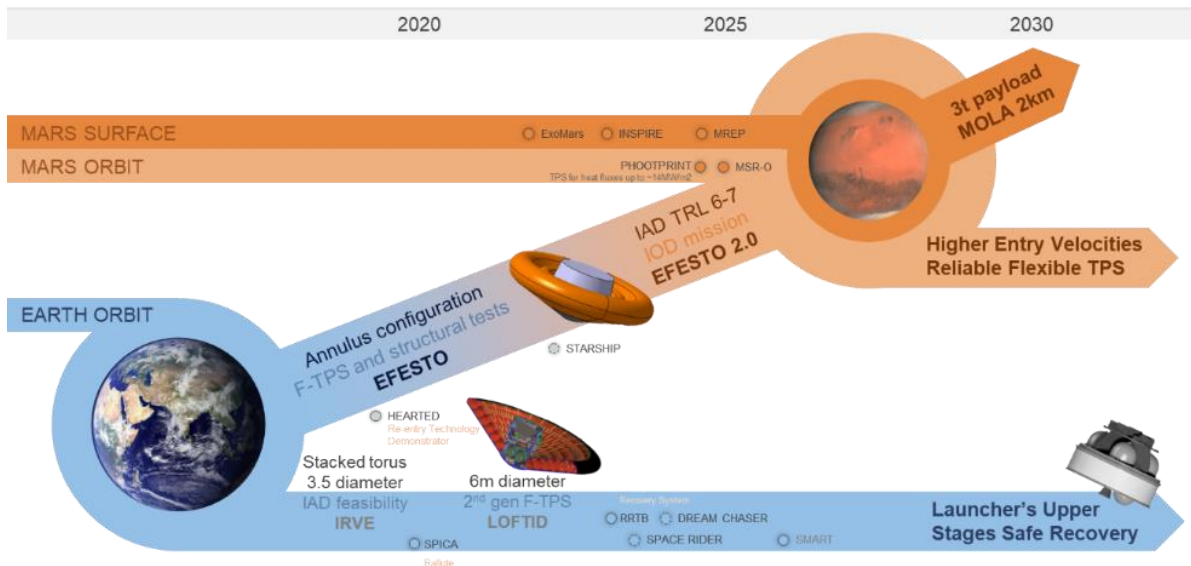

Fig. 23. EFESTO technology roadmap

7. Conclusions

EFESTO project allowed to develop and improve the European know-how in the field of HIAD systems with respect to system design and engineering, key technology design manufacturing and testing. To complete the investigation exercise on these peculiar systems further effort shall be put in place in the future in agreement with the technology roadmap introduced.

The results presented demonstrate that HIAD systems represent an enabling technology for the next class of high-mass Mars exploration missions and this technology can be key in reducing the cost of access to space through upper stage reusability. The need for advancing the European TRL of this technology, which is the primary objective of the EFESTO project, is thus confirmed and the relevance of an IOD mission that will enhance the European know-how in the field, of which the EFESTO consortium represents the core, is reinforced

8. Acknowledgments

This project has received funding from the European Union Horizon 2020 research and innovation programme under grant agreement No 821801. More information available at: <https://cordis.europa.eu/project/id/821801>
The EFESTO consortium acknowledges essential contributions from Thin Red Line Aerospace and ALI Scarl Italia concerning the IAD Demonstrator design, manufacturing, integration and testing processes.

9. References

[1] G. Guidotti, I. Pontijas Fuentes, F. Trovarelli, I Dietlein, S. Callsen, K. Bergmann, J.L.Verant, R.

Gardi, G. Gambacciani, G. Governale, “The EFESTO Project: Advanced European Re-Entry System Based on Inflatable Heat Shield”, 2nd FAR congress, Germany, 2022.

- [2] T. Schleutker, B. Esser, A. Guelhan, J.L.Verant, N. Dellinger, Y. Dauvois, Y. Prevèreaud, G. Gambacciani, G. Guidotti, G. Governale, “Flexible TPS design and testing for advanced European re-entry system based on inflatable heat shield for EFESTO project”, 2nd FAR congress, Germany, 2022.
- [3] R. Gardi, B. Tiseo, M. de Jong, F.Punzo, M.F.Miceli, C. Julien, G. Guidotti, G. Governale, P. Pasolini, “Design development and testing of the Inflatable Structure and its Demonstrator for the EFESTO project”, 2nd FAR congress, Germany, 2022.
- [4] F. Trovarelli, G. Guidotti, D. Bonetti, G. De Zaiacomo, I. Dietlein, G. Gambacciani, G. Governale, J L. Verant, “EFESTO: European research on inflatable heatshields for Mars exploration and upper stages recovery”, 18th International Planetary Probe Workshop, 2021.
- [5] M. de Jong, G. Guidotti, R. Gardi, F. Punzo, M. Miceli, P. Pasolini, D. Bonetti, “HIAD inflatable structure design and prototype development for the EFESTO project”, 18th International Planetary Probe Workshop, 2021.
- [6] ISECG, The Global Exploration Roadmap, Jan 2018.
- [7] https://www.esa.int/About_Us/Ministerial_Council_2016/What_is_space_4.0



More information are available at: <http://www.efesto-project.eu>