

Numerical Modeling of a Pyroshock Test Plate for Qualification of Space Equipment

Original

Numerical Modeling of a Pyroshock Test Plate for Qualification of Space Equipment / Viale, L., Daga, A.P., Garibaldi, L., Fasana, A.. - STAMPA. - 270:(2023), pp. 990-999. (10th European Workshop on Structural Health Monitoring, EWSHM 2022 Palermo 4 July 2022through 7 July 2022) [10.1007/978-3-031-07322-9_100].

Availability:

This version is available at: 11583/2968704 since: 2023-01-11T09:10:36Z

Publisher:

Springer Nature Switzerland AG

Published

DOI:10.1007/978-3-031-07322-9_100

Terms of use:

This article is made available under terms and conditions as specified in the corresponding bibliographic description in the repository

Publisher copyright

Springer postprint/Author's Accepted Manuscript

This version of the article has been accepted for publication, after peer review (when applicable) and is subject to Springer Nature's AM terms of use, but is not the Version of Record and does not reflect post-acceptance improvements, or any corrections. The Version of Record is available online at: http://dx.doi.org/10.1007/978-3-031-07322-9_100

(Article begins on next page)

Numerical Modeling of a Pyroshock Test Plate for Qualification of Space Equipment

Luca Viale^{1,*}, Alessandro Paolo Daga¹, Luigi Garibaldi¹ and Alessandro Fasana¹

¹ Department of Mechanical and Aerospace Engineering, Politecnico di Torino
Corso Duca degli Abruzzi 24, 5 10129 Torino, Italy

*Correspondence: luca.viale@polito.it

Abstract. Over their life, space equipment needs to withstand strong high-frequency shocks, which could cause mission and safety critical damages. In order to verify the compliance with safety standards, pyroshock tests are employed. Based on launch vehicle characteristics, the requirements for the qualification of space equipment are usually established following the NASA-STD-7003A international standards in terms of a Shock Response Spectrum (SRS) representing the damage potential of the shock. Laboratory tests should then match the actual stress conditions reached during a real launch. Historically, this was obtained by means of explosive charges (hence the name “pyroshock”). Nevertheless, to foster repeatability and safety in laboratories, hammers or bullets are commonly used in nowadays shock testing machines.

In this work, a resonant fixture test bench is considered. In this very common layout, a resonant metallic plate is interposed between the impact location and the test component so as to better simulate the shocks. The response of the resonant plate - which determines the required shock response spectrum - is currently empirically tuned by adding masses, damping, stiffness, or by varying the nature of the impact. This study aimed at developing a numerical model able to completely simulate a pyroshock test. Such a model can be used both for designing and for tuning the test bench so as to easily match different SRS requirements for different components under test. This leads to great economical advantages as can cut the calibration times leading to more efficient and effective testing.

Keywords: Numerical Modeling, Pyroshock Test, Plate Dynamics, Inverse Problem, Aerospace.

1 Introduction

In the aerospace and defense fields, pyrotechnic devices (i.e., which exploit high-energy or explosive materials) allow performing essential mechanical functions and, consequently, initiating flight sequences during missions. In fact, they allow to release the different spacecraft stages, the boosters, the cargo satellites, separate other structural subsystems and to deploy attachments of various kinds. However, the activation of explosive charges or - in general - of pyrotechnic devices causes transient mechan-

ical response of the structural elements adjacent to the energy release zone. This phenomenon is known as *pyrotechnic shock* or - more commonly - *pyroshock* and is characterized by its impulsive nature, as well as by the high-frequency response content. These characteristics ensure that pyroshocks frequently cause damages to electronic components but rarely structural failures. In fact, crystalline and ceramic materials - which typically make up optical and electronic systems - are highly sensitive to excitations in the 2-4 kHz frequencies band [1], and their damage can lead to the failure of the space mission.

The experimental simulations of the pyroshocks are, therefore, fundamental for characterizing and verifying the components. In this regard, several technical standards provide guidelines for determining test requirements. Method 517 in MIL-STD-810F [2] and the IEST RP Pyroshock Testing Technique [3] are mentioned among the best known and used standards, but in the following reference will be made to the 7003 standards defined by NASA [4]. NASA-STD-7003 divides pyroshocks in three categories according to the distance between the source and the point of interest and - consequently - basing on the measured spectral content. In particular, these three categories are defined as follows:

- *Near-field*: characterized by a significant spectral content mainly at frequencies above 10 kHz with peak accelerations above 10^5 g. Theoretically, no sensitive hardware should be located in areas close to shock at the design stage. For this reason, the requirements for simulation tests focus primarily on the following two categories.
- *Mid-field*: the frequency band affected by the mid-field pulses is between 3-10 kHz with accelerations of the magnitude order of 10^4 g, mainly caused by wave propagation and structural resonances.
- *Far-field*: structural resonances generate accelerations with peak values lower than 10^3 g and frequencies below 3 kHz.

In general, following the aforementioned guiding principles, the simulations are carried out so as to obtain a simple three-point Shock Response Spectrum (SRS) with the related tolerance limits. These three points are usually defined by the three most relevant frequencies: the minimum and maximum (respectively equal to 100 Hz and 10 kHz) and the knee frequency (between 500-1500 Hz). As shown in Figure 1, test specifications usually have amplitudes with positive slope at low frequencies, followed by a constant level at high frequencies. The amplitude values are in the order of 10^2 - 10^3 g and depend on the spacecraft construction characteristics, the type of explosions and the equipment position. The literature also defines guidelines for the choice of tolerances. In this case, reference is often made to the ESA ECSS experimental standard [5], which constrains the SRS within a tolerance of +6 dB and -3 dB with respect to the nominal spectrum. Although alternative methods have been proposed for the shock qualification of components [6], the SRS is commonly used to characterize and compare the frequency contents of pyroshock tests [7]. When no further information referring to the SRS is specified, reference is usually made to the maximum SRS, i.e., the maximum absolute response recorded with respect to a large number of systems with a Single Degree Of Freedom (SDOF), each of which has different natural frequencies and damping coefficient $\zeta_{\text{SRS}} = 0.05$.

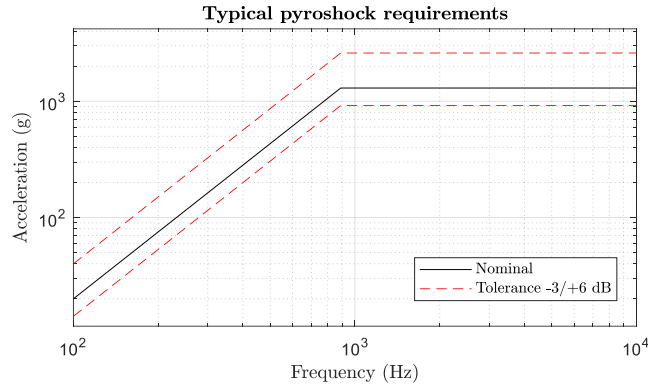

Figure 1. Typical pyroshock requirements defined following the standard guidelines and considering the spacecraft construction characteristics.

A few studies concerning both the numerical and experimental simulation of pyroshock exist in the literature. Depending on the shock type to be simulated, the test requirements and other factors, different methods and various excitation structures can be used. Resonant plates hit by a typically metallic object (e.g., pendulum, hammer, dropping mass, projectile, or piston) are the most widely used and the best performing pyroshock simulation method, compared to the more limiting electrodynamic shakers and the very same pyrotechnic devices. The resonant plates allow the object under test to be exposed to mid and far-field shocks, thus generating effects similar to the stresses caused by a pyroshock. So far, various experimental configurations of vibrating plates have been studied and used. They differ, for instance, in the dimensions, material, orientation and constraint conditions of the slab. In general, in addition to the same test bench structure and the well-known resonant plate, the other main elements constituting the experimental setup are the anvil plate, the impacting body and the object under test. In addition to presenting the design of a pyroshock test bench, in [8] the effects that the different design variables (e.g., the mass, material and geometry of the impacting body, the anvil plate material, the impact velocity and positioning, the plate constraint conditions) involve in terms of SRS are analyzed.

Until recently, many pyroshock simulation techniques required a large amount of trial-and-error to obtain the correct test conditions as well as the desired SRS profile [9,10]. In addition to the purely technical difficulties related to the plate tuning, it must further be considered that the test requirements may vary according to the characteristics of the pyroshock to simulate. The combination of these factors means that a considerable effort is necessary for the tuning and preparation of the experimental setup, leading consequently to increases in terms of downtime and costs. For these reasons, the proposed study aims at presenting a first parametric model to numerically simulate the behavior of the plate and the object under test. Therefore, this model allows both simply designing the plate - optimizing the numerous variables and meeting the SRS requirements - and quickly and accurately tuning and calibrating the entire test bench for the execution of the tests. Some studies present pyroshock test simulation models in the literature. For example, a numerical model based on NASTRAN

and DYTRAN is proposed in [11]. However, the computational effort and the running time required to process the simulation are significant, thus not allowing the iterative use for the configuration and fine-tuning of each test.

In addition to describing the proposed method, the article shows the obtained numerical results and - for this purpose - the plate designed by Sandia National Lab and described in [12] was considered. Then, a comparison with the experimental data is shown to demonstrate the method validation.

This paper is structured as follows. Section 2 describes the model with its different parameters, while Section 3 reports the results concerning both the comparison with the experimental data and the definition of the test bench configuration. Finally, Section 4 draws the conclusions.

2 Methodology

The proposed model was developed to simulate the transverse dynamic behavior of rectangular plates with variable geometry through a Multi Degree Of Freedom (MDOF) model. Since it is a two-dimensional (2D) model, the geometric parameters which could vary are the base and the height of the plate. On the other hand, the thickness solely affects the plate mass. In addition to these geometric parameters, the model allows establishing the plate material (e.g., aluminum alloys, iron alloys), setting the appropriate density and assuming a damping coefficient ζ constant in frequency (in the analysis case, $\zeta = 0.05$). Being an MDOF model, it is possible to establish the number of degrees of freedom by setting the number of nodes (ND_b and ND_h) for each plate side. Furthermore, the proposed model allows defining the position (in terms of nodes) of impulse generation, the SRS measurement, and integrating the object under test with configurable dimensions, mass and positioning.

Since it is not possible to make assumptions and approximations on the stiffness value, a Finite Element Analysis (FEA) was initially carried out using specific software (e.g., Inventor, SolidWorks) in order to determine the resonance frequencies of the relevant modes of interest, the MDOF model has been tuned accordingly with these frequencies.

It is assumed that the plate is divided into $ND_b \times ND_h$ sub-plates with constant thickness and mass equal to $1/(ND_b \times ND_h)$ of the total one. Generating a model in which each sub-plate interacts with the adjacent ones by means of a spring-damper system (with stiffness k and damping c so as to set $\zeta = 0.05$ constant in frequency), it was possible to reconstruct the matrices of stiffness K , damping C and mass M . The latter matrix takes into account both the total mass of the plate and that of the additional component under test, which has established specifications in terms of dimensions and mass. By way of example, Figure 2 highlights the nodes in which the object under test contributes as a massive element.

With the aforementioned matrices and free boundary conditions on the four edges, it was possible to carry out a modal analysis and to calculate the receptance α_{jk} with the first n modes, where j indicates the node where the impulse is generated and k the one where it is measured.

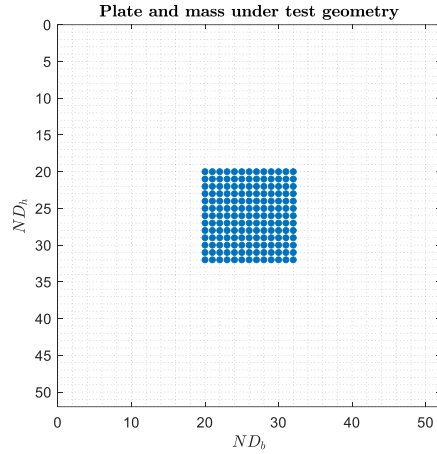

Figure 2. Plate (white) and mass under test (blue) geometry and relative positioning.

It was possible to calculate the SRS of the plate with the reported conditions, considering a frequency response for the unit impulse (by exploiting the transmissibility T of a mass-spring-damper system with $\zeta_{SRS} = 0.05$ and a natural frequency Ω_c tuned for having a frequency resolution of 1/24 octave). Figure 3 shows a first simplified model of the impact-plate-SRS mass system, where m_p is the impacting mass, m represents the whole plate, and all the different m_{SRS} stand for the SDOF systems tuned at each frequency Ω_c . This simplified model was not used for the numerical simulation, but rather the MDOF model of the plate was developed as shown in more detail in Figure 4. In [13] an analogous one-dimension MDOF model is developed.

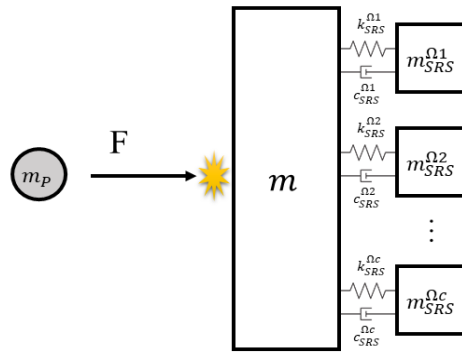

Figure 3. Model of the impact-plate-SRS mass system.

The analysis performed was carried out entirely in the frequency domain: the Inverse Fast Fourier Transform (IFFT) was used exclusively to calculate the SRS, as per its definition. Eq. (1) summarizes the mathematical passages that allow - starting from the plate receptance - obtaining the SRS requirements, as well as the necessary related momentum p .

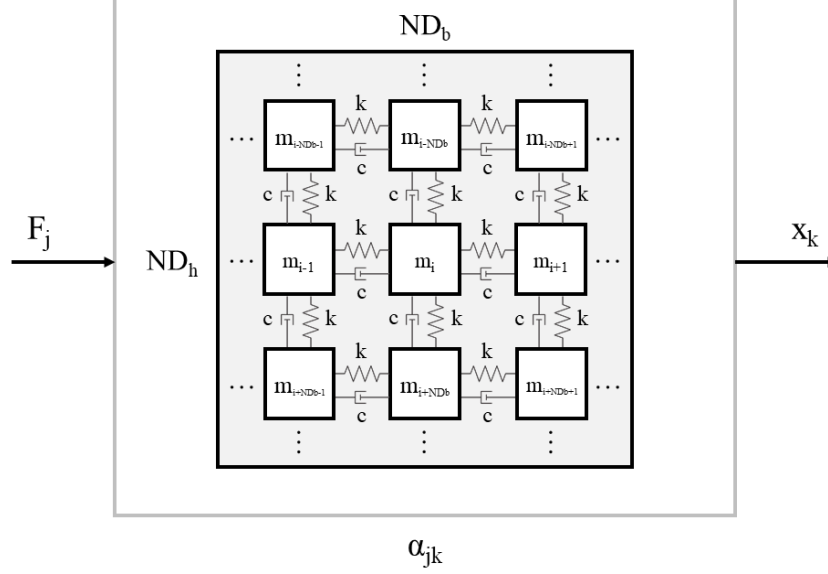

Figure 4. Scheme representing the MDOF model used to study the plate behavior, considering a force F_j in j -th node and the related displacement x_k in k -th node. The mass m_i represents the i -th sub-plate linked by a spring-damper system with the adjacent ones.

$$\ddot{x}_{SRS}(\Omega) = F(\Omega) \cdot \frac{x(\Omega)}{F(\Omega)} \cdot \frac{x_{SRS}(\Omega)}{x(\Omega)} \cdot \frac{\ddot{x}_{SRS}(\Omega)}{x_{SRS}(\Omega)} = p \cdot F_1(\Omega) \cdot \alpha_{jk}(\Omega) \cdot T(\Omega) \cdot \Omega^2 \quad (1)$$

$F(\Omega)$ is the spectrum of the used pulse which is assumed as rectangular, $F_1(\Omega)$ is the spectrum of a rectangular pulse with unitary momentum (the force value depends on the duration τ of the pulse), $x(\Omega)$ is the displacement of the plate, $x_{SRS}(\Omega)$ is the displacement of the SRS mass, $\ddot{x}_{SRS}(\Omega)$ its acceleration (in g), p is the momentum demanded to reach the level of the SRS requirements, $T(\Omega)$ is the transmissibility of each SRS system, and Ω is the system excitation frequency. Considering a collision accompanied by deformation and using the Hertzian contact theory, it is possible to derive the collision time τ as proposed in [14]:

$$\tau = 3.29 \cdot (1 - \nu^2)^{\frac{2}{5}} \left(\frac{m_p^2}{RE^2 v_p} \right)^{\frac{1}{5}} \quad (2)$$

where ν and E are respectively the Poisson's ratio and the Young's modulus of the material, m_p , R and v_p are respectively the mass, the radius and the velocity of the impacting object. It should be noted that momentum $p = m_p \cdot v_p$.

3 Results

It is possible to entirely simulate a pyroshock test thanks to the proposed numerical method. In particular, its use is twofold: it can be exploited both for the design and dimensioning of the resonant plate and the test bench, and for the tuning and calibration of each test, obtaining the measurement and impact positions, the mass and speed of the impacting body. Before proposing some possible solutions to these problems, the validation of the proposed method is demonstrated by comparison with the experimental results obtained by Sandia National Lab in [12]. Table 1 summarizes the plate characteristics and the configuration parameters of the model. Figure 5 shows how the MDOF model, properly tuned to the FEM plate, is able to faithfully reproduce the experimental results. The value of the momentum p was obtained so as to minimize the Root Mean Square Error (RMSE) between the experimental and simulated curves. Furthermore, Figure 6 shows the obtained modal shapes of the first 13 modes of the plate (the first mode has not been reported as it would concern the plate rigid translation, having imposed free boundary conditions). It is thus possible to observe that only some modes give an effective contribution as the position of the object under test may vary.

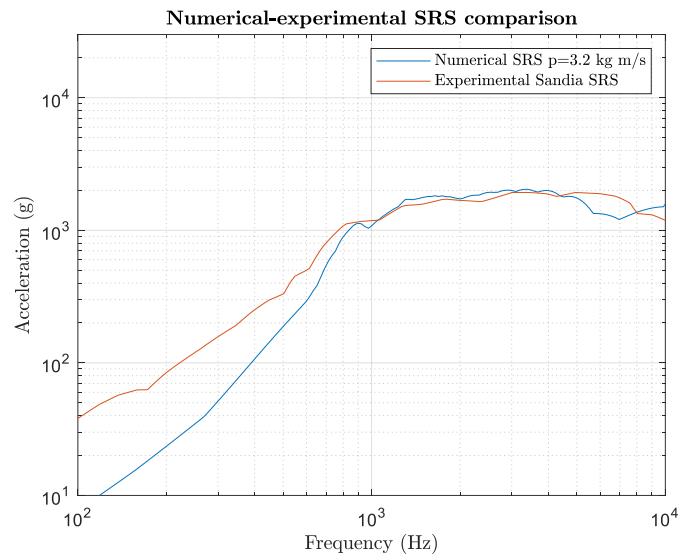

Figure 5. Comparison between the simulated plate SRS (with $M=51 \times 51=2601$ DOF and assuming momentum equal to $p = 3.2$ kg m/s) and the experimental results obtained with the Sandia reference plate.

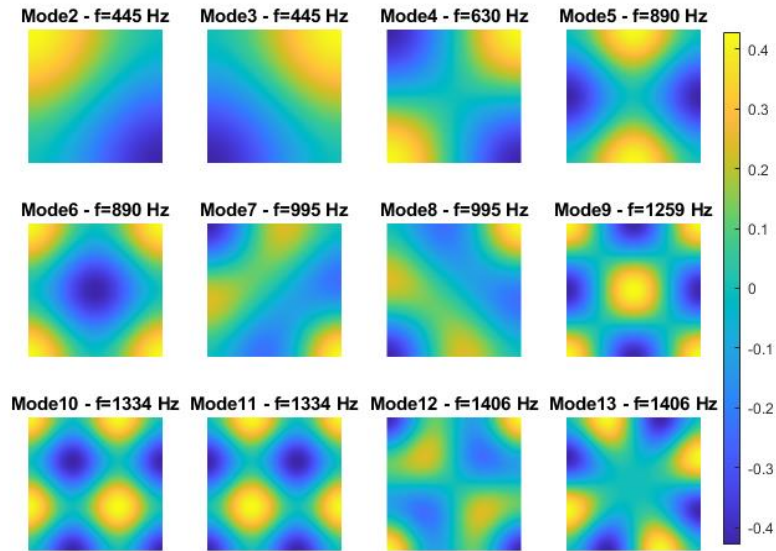

Figure 6. Modal shapes of the first 13 modes.

Table 1. Plate characteristics and model configuration parameters.

Quantity	Value	Notes
<i>Base</i>	500 mm	divided in 51 nodes
<i>Height</i>	500 mm	divided in 51 nodes
<i>Width</i>	38.1 mm	
<i>Material</i>	aluminum	$\rho = 2700 \text{ kg/m}^3$; $\zeta = 0.05$
<i>Plate mass</i>	25.72 kg	
<i>Pulse position</i>	central	
<i>Measuring position</i>	central	
<i>Mass under test</i>	0 kg	

With the tuned model verified, it is possible to obtain the results of the inverse problem. Therefore, assuming the aforementioned plate, it is possible to calculate the momentum necessary to reach the SRS requirements. Table 2 shows a possible configuration of the test bench (in the case of using a projectile as impacting mass).

Table 2. Impact mass configuration in a projectile case with momentum $p = 3.2 \text{ kg m/s}$.

Projectile-like assumptions	
Mass	0.53 kg
Velocity	6 m/s

Finally, to further show the usefulness of the proposed model, an example of inverse problem is reported. After fixing the plate dimensions, it is possible to simulate the system behavior during a component qualification test. By setting the mass and dimensions of the object under test, it is possible to obtain its optimal positioning and the new specifications of the impact to generate. Figure 7 shows the results obtained by adding a 7.5 kg object (divided into 13×13 nodes) positioned in the center of the plate.

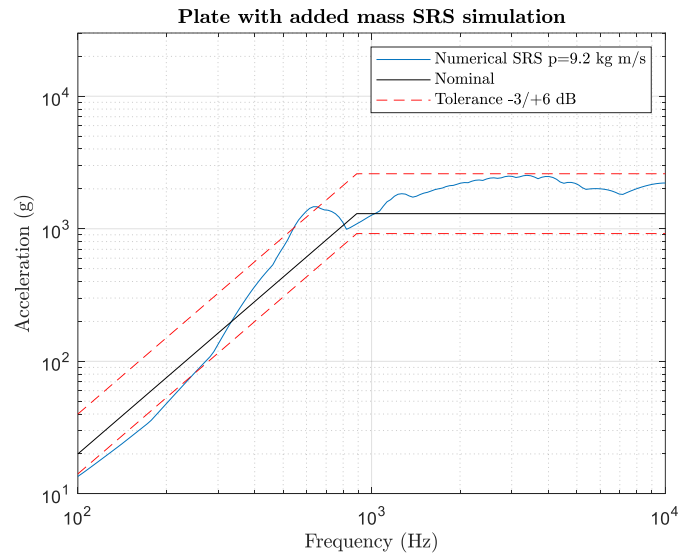

Figure 7. SRS numerical simulation of the resonant plate with the additional mass of the component under test. The momentum required to satisfy the requirements is $p = 9.2$ kg m/s.

4 Conclusions

This work has proposed a parametric MDOF model, which allows to numerically simulate a pyroshock test with good approximation. This model permits both to facilitate the test bench design and make the calibration quicker and more precise, as conditions and requirements vary. The SRS profile obtained from the simulation showed a trend similar to the experimental one, consequently validating the goodness of the proposed model. Furthermore, the proposed model does not require a high computational effort, thus making the algorithm processing faster. This permits a simple use of the model to calibrate the resonant plate per each test, according to the requirements and experimental conditions.

Finally, this work foresees future developments to further improve the model accuracy, considering a larger number of factors. In addition, the integration of an optimizer based on Genetic Algorithms (GA) is also envisaged to automatically obtain the best solutions to both problems (direct and inverse).

References

- [1] Lee J-R, Chia CC, Kong C-W. Review of pyroshock wave measurement and simulation for space systems. *Measurement* 2012;45:631–42. <https://doi.org/10.1016/j.measurement.2011.12.011>.
- [2] MIL-STD-810F. Department of Defense Test Method Standard for Environmental Engineering Considerations and Laboratory Tests Version F, US Government Printing Office 2000.
- [3] One AP. *Pyroshock Testing Techniques* 2009.
- [4] Himmelblau H. *Pyroshock Test Criteria*. NASA-STD-7003A; 2011.
- [5] ECSSSecretariat ESA, ESTEC R. ECSS-E-ST-10-03C. *Space Engineering-Testing*, ESA Publications Division, Noordwijk, The Netherlands 2012.
- [6] Sisemore C. *Defining Resonant Plate Shock Test Specifications in the Time Domain*. Sandia National Lab.(SNL-NM), Albuquerque, NM (United States); 2019.
- [7] Alexander JE. Shock response spectrum-a primer. *Sound & Vibration* 2009;43:6–15.
- [8] Martin J. *Development of a shock test facility for qualification of space equipment* 2012.
- [9] Davie NT, Bateman VI. *Pyroshock simulation for satellite components using a tunable resonant fixture, phase 1*. NASA STI/Recon Technical Report N 1992;93:22975.
- [10] Davie NT, Bateman VI. *Pyroshock simulation for satellite components using a tunable resonant fixture-phase 2*. Sandia National Labs., Albuquerque, NM (United States); 1997.
- [11] Kiryenko S, Piret G, Kasper J. *ESA/ESTEC shock bench presentation*. *Spacecraft Structures, Materials and Mechanical Testing* 2005, vol. 581, 2005.
- [12] Sisemore C, Spletzer MA. *Design of a Resonant Plate Shock Fixture to Attenuate Excessive High-Frequency Energy Inputs*. Sandia National Lab.(SNL-NM), Albuquerque, NM (United States); 2017.
- [13] Daga AP, Fasana A, Garibaldi L, Marchesiello S. *On the use of PCA for Diagnostics via Novelty Detection: interpretation, practical application notes and recommendation for use*. *PHM Society European Conference*, vol. 5, 2020, p. 13–13.
- [14] Leroy B. *Collision between two balls accompanied by deformation: a qualitative approach to Hertz's theory*. *American Journal of Physics* 1985;53:346–9.