

Influence of Random Modulated Power Converter on G3 Power Line Communication

*Original*

Influence of Random Modulated Power Converter on G3 Power Line Communication / Hamid Beshir, Abduslam; El Sayed, Waseem; Wan, Lu; Grassi, Flavia; Crovetto, PAOLO STEFANO; Liu, Xiaokang; Wu, Xinglong; Madi, Amr; Smolenski, Robert; Amedeo Pignari, Sergio. - In: APPLIED SCIENCES. - ISSN 2076-3417. - ELETTRONICO. - 12:11(2022). [10.3390/app12115550]

*Availability:*

This version is available at: 11583/2965395 since: 2022-08-23T14:17:25Z

*Publisher:*

MDPI

*Published*

DOI:10.3390/app12115550

*Terms of use:*

This article is made available under terms and conditions as specified in the corresponding bibliographic description in the repository

*Publisher copyright*

(Article begins on next page)

## Article

# Influence of Random Modulated Power Converter on G3 Power Line Communication

Abduselam Hamid Beshir <sup>1,\*</sup>, Waseem El Sayed <sup>2,3</sup>, Lu Wan <sup>1</sup>, Flavia Grassi <sup>1</sup>, Paolo Stefano Crovetto <sup>4</sup>, Xiaokang Liu <sup>1</sup>, Xinglong Wu <sup>1</sup>, Amr Madi <sup>2</sup>, Robert Smolenski <sup>2</sup> and Sergio Amedeo Pignari <sup>1,\*</sup>

<sup>1</sup> Department of Electronics, Information and Bioengineering (DEIB), Politecnico di Milano, 20133 Milan, Italy; lu.wan@polimi.it (L.W.); flavia.grassi@polimi.it (F.G.); xiaokang.liu@polimi.it (X.L.); xinglong.wu@polimi.it (X.W.)

<sup>2</sup> Institute of Automatics, Electronics and Electrical Engineering, University of Zielona Góra, 65-417 Zielona Góra, Poland; waseem.elsayed@ieee.org (W.E.S.); amr.madi@ieee.org (A.M.); r.smolenski@iee.uz.zgora.pl (R.S.)

<sup>3</sup> Marine Engineering Technology Department, College of Maritime Transport and Technology, Arab Academy for Science and Technology and Maritime Transport, Abou Keer Campus, P.O. Box 1029, Alexandria 21500, Egypt

<sup>4</sup> Department of Electronics and Telecommunications (DET), Politecnico di Torino, 10129 Turin, Italy; paolo.crovetto@polito.it

\* Correspondence: abdulselamhamid.beshir@polimi.it (A.H.B.); sergio.pignari@polimi.it (S.A.P.)

**Abstract:** Power Line Communication (PLC) technologies are being used in many applications and offer the advantage of utilizing existing power cables for both power and data transmission, thus minimizing cost and complexity. Nevertheless, PLC technology requires further investigation to solve possible co-existence issues. Indeed, recent studies confirmed that alternative modulation schemes such as Random Pulse Width Modulation (RPWM), applied to switching-mode power converters to minimize conducted emissions, detrimentally interfere with the PLC system. This paper presents an experimental test campaign aimed at investigating the effects of RPWM on the G3-PLC system, with the final goal of understanding the conditions under which RPWM schemes can be considered as an effective alternative to conventional Pulse Width Modulation (PWM) in applications involving PLC systems. In details, the effects of different RPWM parameters such as switching frequency, modulation index, and Random Number Update Rate (RNUR) on the G3-PLC is investigated. In addition, different RPWM schemes such as Random Frequency Modulation (RFM) and Random Pulse Position Modulation (RPPM) are compared in terms of performance so as to highlight which RPWM is best suited to assure coexistence with PLC systems. The impact of RPWM on the communication channel is evaluated in terms of Frame Error Rate (FER), Channel Capacity, and Channel Capacity Loss metrics. Experimental results confirmed that randomly modulated converters with switching frequencies near the G3-PLC bandwidth cause more significant disturbance and possible coexistence issues than the switching frequencies out of this range. Results also show that the modulation index and the RNUR of RPWM have a direct effect on the communication channel. Moreover, a trade-off between Electromagnetic Interference (EMI) reduction and coexistence issues is observed: RFM, which is very effective for EMI reduction, is found to be very disruptive for G3-PLC, compared to alternative random modulation techniques such as RPPM.

**Keywords:** conducted emission (CE); Electromagnetic Compatibility (EMC); Electromagnetic Interference (EMI); Frame Error Rate (FER); Power Line Communication (PLC)



**Citation:** Beshir, A.H.; El Sayed, W.; Wan, L.; Grassi, F.; Crovetto, P.S.; Liu, X.; Wu, X.; Madi, A.; Smolenski, R.; Pignari, S.A. Influence of Random Modulated Power Converter on G3 Power Line Communication. *Appl. Sci.* **2022**, *12*, 5550. <https://doi.org/10.3390/app12115550>

Academic Editors: Zbigniew Kaczmarczyk, Pooya Davari and Zbigniew Rymarski

Received: 7 May 2022  
Accepted: 29 May 2022  
Published: 30 May 2022

**Publisher's Note:** MDPI stays neutral with regard to jurisdictional claims in published maps and institutional affiliations.



**Copyright:** © 2022 by the authors. Licensee MDPI, Basel, Switzerland. This article is an open access article distributed under the terms and conditions of the Creative Commons Attribution (CC BY) license (<https://creativecommons.org/licenses/by/4.0/>).

## 1. Introduction

Modern society is becoming increasingly interconnected, and the electric power grid is providing, besides energy from the sources to the loads, a main path for communication systems. Although, in many applications, separate lines are used for power delivery

and data communication, in recent installations they have been merged by resorting to Power Line Communication (PLC) technology [1–3]. Transmitting power and data through a single interconnect is highly desirable in all those fields in which reduction of cost, mass, and weight is the target. Therefore, PLC is attracting increasing interest in different applications, e.g., Smart Grid (SG), Advanced Meter Infrastructure, home automation, and electric vehicles [4–7].

G3-PLC is a widespread communication protocol in many PLC applications, such as in the SG framework. However, recent research results put in evidence that it may suffer from potential coexistence issues associated with the power converter modulation scheme being used. In particular, alternative Pulse Width Modulation (PWM) schemes such as Random Pulse Width Modulation (RPWM), which are largely adopted as a cost-effective alternative to traditional EMI filters to reduce the Conducted Emissions (CE) from power converters, have been found to interfere with the PLC [8–11].

The effects of power converter modulation schemes on PLC systems are an open research area, and enough research has not yet been conducted. There are contributions discussing the comparison between conventional PWM and RPWM effects on the PLC system. For instance, in [12], the comparison between the deterministic and random modulation effects on the narrow-band G3-PLC performance in terms of Frame Error Rate (FER) is presented. In that work, only one type of RPWM scheme, i.e., Random Frequency Modulation (RFM), was considered, and it was found that the RFM results in a higher FER than the deterministic modulation in a specific switching frequency range (50–75 kHz) near the center frequency of the G3-PLC (63 kHz). In [13], the influence of deterministic and random modulation on the transmission errors of a serial communication systems is compared using a mathematical model, where no significant differences between the two modulation schemes were observed. Additionally, the influence of a random frequency modulated SiC-based buck converter on the G3-PLC Channel Capacity and Channel Capacity Loss is investigated in [14], where it is shown that RFM impairs the G3-PLC channel performance.

In other contributions, the interference between randomly modulated converters and other communication protocols is studied. For instance, in [15], the effects of random frequency modulated power converters on the low frequency digital communication systems were studied, and it was proven that RPWM does not have a significant effect on digital communication systems. In general, only specific random modulation schemes (mainly RFM) were investigated in the literature, and further investigations on other random modulation strategies are required. More recently, the effects of Random Pulse Position (RPPM) on the PLC system are compared with conventional PWM in [16]. However, the analysis was carried out based on simulations only, and experimental verification is needed to draw general conclusions.

Additional investigations are required to determine which random modulation scheme is most suitable for power converters in applications involving PLC. Furthermore, there are also many parameters that influence random modulation schemes, such as the switching frequency of the RPWM, the modulation index, and the Random Number Update Rate (RNUR). Hence, more analysis is required to identify constraints on these parameters, assuring coexistence with PLC. For instance, the switching frequency of the randomly modulated power converter is not constant, i.e., it depends on the specific application, and it is very difficult to draw general conclusions about coexistence by considering specific switching frequencies only. Furthermore, the modulation index specifies by how much the pulse position of the RPPM should vary, and it surely plays a significant role on the coexistence. The RNUR determines how fast the pulse position of RPPM should change, and it obviously also affects the operation of the RPPM.

In line with these objectives, this work is aimed at investigating the effects of the RPPM on the G3-PLC system and at comparing the results with previous experimental findings obtained with other modulation strategies (such as the RFM) to understand which modulation scheme could better assure coexistence. To this end, an experimental test

campaign aimed at examining the effects of the main parameters that affect the RPPM, such as the switching frequency, modulation index, and the RNUR, on the performance of G3-PLC is carried out. The performance of the G3-PLC is assessed by considering the FER, the Channel Capacity, and the Channel Capacity Loss.

The remaining part of the manuscript is organized as follows. Section 2 introduces the details of Random Modulation. The description of the G3-PLC and the experimental test setup is presented in Sections 3 and 4, respectively. The obtained results are then presented and discussed in Section 5. Finally, in Section 6, some conclusions are drawn.

**2. Random Pulse Position Modulation**

In RPWM, one of the switching parameters of the PWM signal, such as switching period, pulse position, and pulse width, are varied randomly in order to spread the noise exiting power converters. Therefore, RPWM can be classified as Random Frequency Modulation (RFM), Random Pulse Position Modulation (RPPM), and Random Duty-Cycle Modulation (RDCM), depending on the parameter, which is made random [17]. Figure 1 shows the RPWM signal, where ‘T’ is switching period, ‘Δ’ is the pulse position, and ‘d’ denotes pulse width.

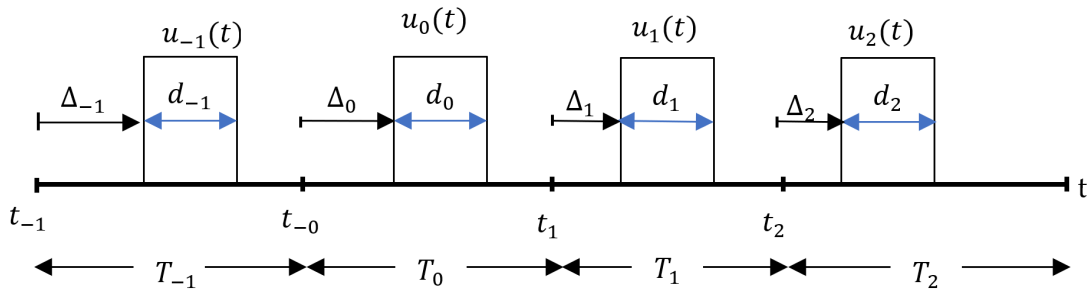


Figure 1. Random switching signal.

In order to investigate the properties of RPWM, it is important to consider the Power Spectral Density (PSD) (in particular for RPPM). For conventional PWM, the PSD can be directly determined from the Fourier Series expansion of the PWM signal (1).

$$S(f) = \sum_{n=-\infty}^{\infty} |a_n|^2 \delta(f - nf_1) \tag{1}$$

or indirectly, by using the autocorrelation/PSD relationship [18–20]:

$$S(f) = \int_{-\infty}^{\infty} R(\tau) e^{-i\omega\tau} d\tau \tag{2}$$

where  $S(f)$  is the PSD of the PWM signal,  $|a_n|$  is the magnitude of the Fourier Series coefficients,  $f_1$  is the switching frequency, and  $R(\tau)$  is the autocorrelation of the switching signal, respectively.

However, it is not straightforward to apply the above formulas to find the PSD of RPWM signals, because they are random and can be described only by a probabilistic level using the theory of stochastic processes such as Wide-Sense Stationary (WSS) random processes.

The PSD of a RPPM is derived in [20] by assuming the constant switching period and pulse width of the RPWM shown in Figure 1.

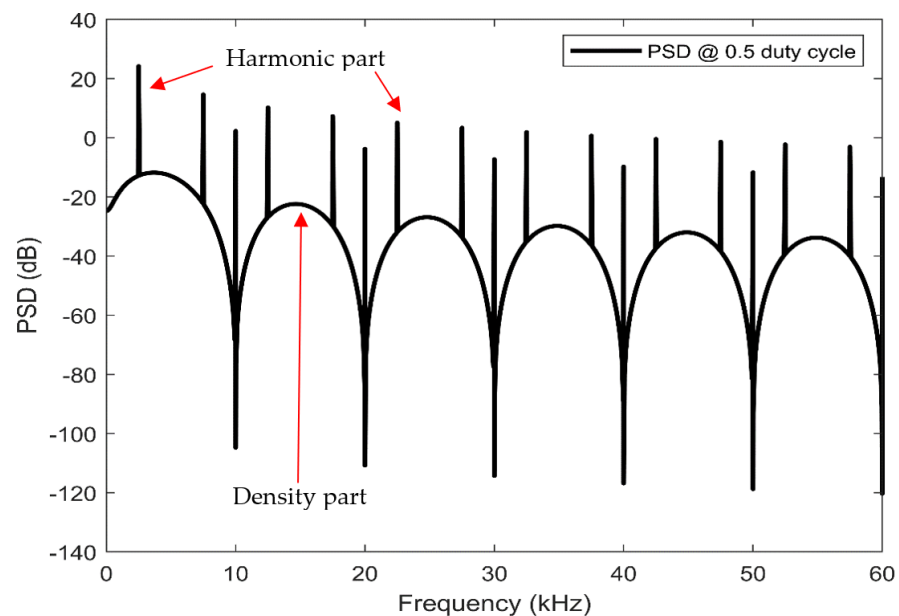
$$S(f) = \frac{1}{T} |U(f; d)|^2 \left[ 1 - |E\{e^{-i\omega\Delta}\}|^2 + \frac{1}{T} |E\{e^{-i\omega\Delta}\}|^2 \sum_{n=-\infty}^{\infty} \delta\left(f - \frac{n}{T}\right) \right] \tag{3}$$

where  $U(f; d)$  is the Fourier transform of the sampling pulse  $u(t)$ :

$$u(t) = \begin{cases} 1, & \text{for } 0 \leq t \leq d \\ 0, & \text{otherwise} \end{cases} \quad (4)$$

$E\{e^{-j\omega\Delta}\}$  is the expectation of the probability density function of the random pulse position, which depends on the distribution of the random number, and  $\omega = 2\pi f$ .

As an example, the PSD of RPPM with 5 kHz switching frequency and 0.5 duty ratio is shown in Figure 2. In this case, a uniformly distributed random number is used to vary the random pulse position. Of course, the shape of the spectrum may change if the distribution of the random number changes, e.g., if a normal distribution is used. However, the spectrum always exhibits both the density and the harmonic part, unlike other modulation schemes. For instance, the RFM spectrum only exhibits the density part [20]. This makes RPPM less effective compared to RFM in minimizing the CE of power converters. Nevertheless, this property will play a significant role in making RPPM more compatible than RFM with communications systems.



**Figure 2.** PSD of the switching signal with uniformly distributed random pulse position.

### 3. Overview of G3-PLC

Existing PLC technologies can be categorized, depending on the bandwidth, into: Ultra Narrowband PLC (UNB-PLC), Narrowband PLC (NB-PLC), and Broadband PLC (BPL). UNB-PLC refers to systems using very narrow bandwidth for data transmission in the frequency range below 3 kHz and is limited to data rates of a few hundreds of bps. NB-PLC refers to systems that work with medium data rates in frequency interval between 3 and 500 kHz. This frequency range includes the European CENELEC bands, the US FCC band, the Chinese band, and the Japanese ARIB band, as summarized in Table 1. Finally, BPL encompasses a large variety of systems that aim at high data rates, operating in the frequency range from 1 MHz up to 250 MHz [21,22].

G3-PLC belongs to the category of NB-PLC and is developed by the G3-PLC Alliance. G3-PLC exploits the Orthogonal Frequency Division Multiplexing (OFDM) modulation technique, which enables faster and more cost-efficient data transfer over existing power lines. G3-PLC can be used either on the low frequency CENELEC A band or in the high frequency band (150–500 kHz), covering the frequency bands reported in Table 1 [23,24].

The G3-PLC selected for this activity works in the low frequency CENELEC A band, with specific frequency between 35 kHz and 91 kHz (see Table 2 for details).

**Table 1.** Summary of available NB-PLC frequency bands in different regions of the world.

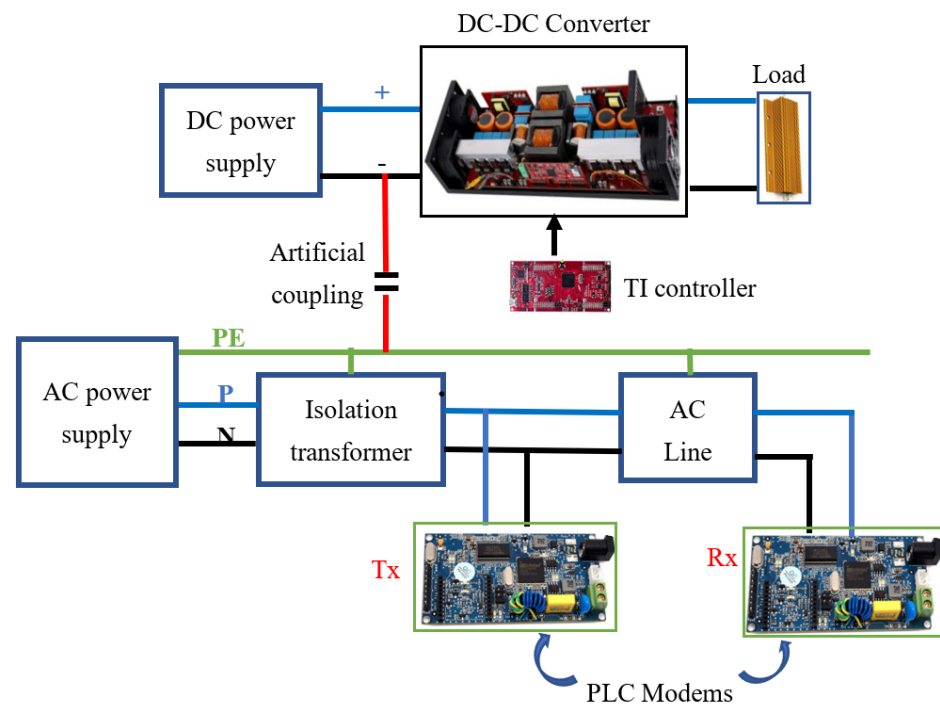
Region	Organization	Frequency Band (kHz)
EU	CENELEC A	3–95
	CENELEC B	95–125
	CENELEC C	125–140
	CENELEC D	140–148.5
USA	FCC	10–490
CHINA	EPRI	3–500
JAPAN	ARIB	10–450

**Table 2.** Specifications of the G3-PLC considered in this work.

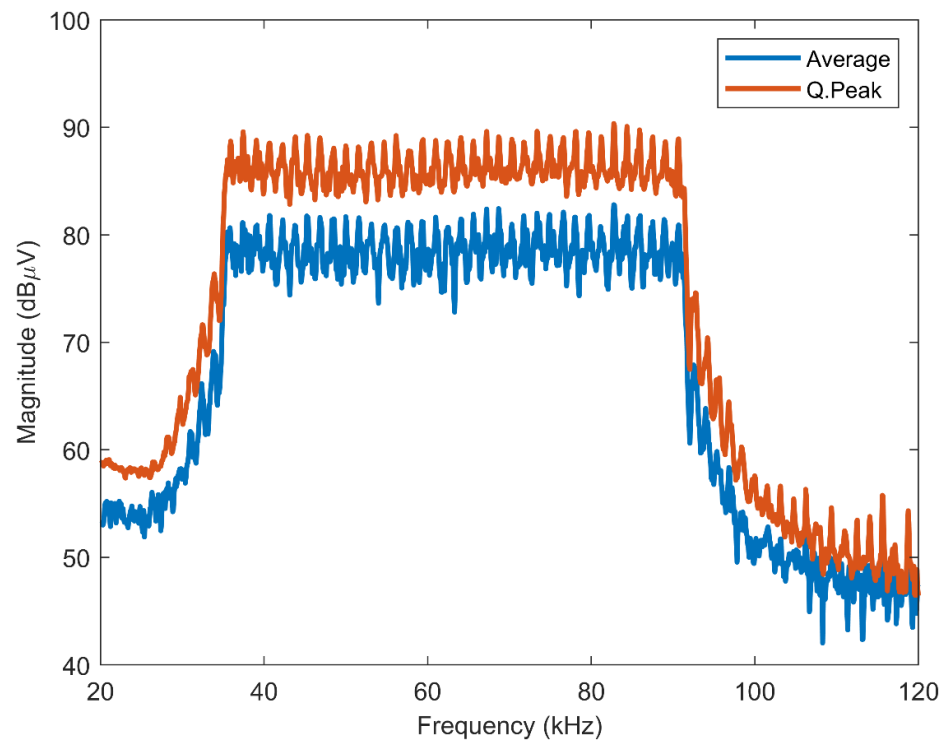
Layer	Feature	
PHY	Modulation	OFDM
	No. of sub carriers	36
	Frequency Band	CENELEC A (35–91 kHz)
	Sub carrier modulation	DBPSK
	Max data rate	up to 34 kbps
	Sent frames	3000
	Time between frames	100 ms

#### 4. Experimental Test Setup

A principle drawing of the test bench is shown in Figure 3. Two G3-PLC modems are used as transmitter and receiver, in the frequency band 35–91 kHz (see spectra in Figure 4), and are connected by a 42-m-long 230 V AC cable to transmit the communication signal between the two AC line terminals. An isolation transformer is used to separate the AC line from the grid. The AC line is coupled to the random modulated DC-DC converter through a coupling capacitor of 10 nF. In this work, a three-phase inverter is used, and one of its legs is used as a buck DC-DC converter (step-down 50 V DC source to 25 V with a duty cycle of 0.5). The converter has a maximum DC link voltage capacity of 450 V with a 2200  $\mu$ F DC link capacitor. Six IXGH40N60C2D1 IGBTs are deployed in this specific converter circuit. The output of the DC-DC converter is connected to a variable resistor load fixed at 8  $\Omega$ .

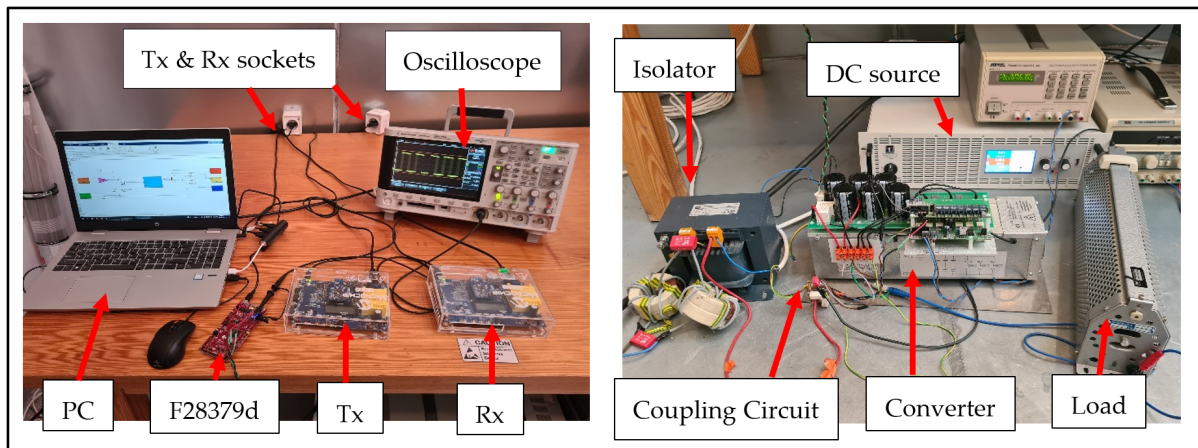


**Figure 3.** Schematics of the experimental test bench with the G3-PLC system coupled to the DC-DC converter through a coupling capacitor.



**Figure 4.** Frequency spectrum of the exploited G3-PLC signal.

PWM/RPPM can be easily implemented using a microcontroller and SIMULINK. Hence, the code for a specific modulation technique is generated using SIMULINK and deployed to the F28379D launchpad for real time operation (see Appendix A). A picture of the experimental test setup is shown in Figure 5.



**Figure 5.** Experimental test bench.

## 5. Results and Discussion

The performance of the G3-PLC is assessed by considering the FER, the Channel Capacity, and the Channel Capacity Loss metrics. The FER indicates the percentage of data frames correctly received over the total data frames sent through the communication system, and it can be determined as:

$$FER(\%) = \frac{(Sent\ frames - Received\ frames)}{(Sent\ frames)} \times 100 \quad (5)$$

The Channel Capacity,  $C$ , indicates the maximum bits of data that the communication system can transmit in the unit time [25], and is defined as:

$$C = \int_{f_1}^{f_2} \log_2 \left( 1 + \frac{S(f)}{N(f)} \right) df \tag{6}$$

where  $f_1$  and  $f_2$  are the lower and upper frequency bands of the G3-PLC,  $S(f)$  is the PSD of the G3-PLC, and  $N(f)$  is the PSD of the noise, which encompasses two contributions:

$$N(f) = N_0(f) + N_{EMI}(f) \tag{7}$$

where  $N_0(f)$  denotes the PSD of the background noise and  $N_{EMI}(f)$  denotes the PSD of the noise from the DC-DC converter. Eventually, the Channel Capacity Loss is defined as:

$$C_{Loss}(\%) = \frac{(C_0 - C_{G3})}{C_0} \times 100 \tag{8}$$

where  $C_{G3}$  and  $C_0$  denote the Channel Capacity of the G3-PLC with and without the noise from the DC-DC converter ( $N_{EMI}$ ).

5.1. Effects of the Converter Switching Frequency

This section presents experimental results showing the effects of the switching frequency of a randomly modulated power converter on the G3-PLC system. Hence, different switching frequencies from 10 kHz to 100 kHz are considered for this analysis.

Figure 6 shows the FER calculated from 3000 frames of data transmitted through the G3-PLC when different switching frequencies are applied to the DC-DC converter resorting to RPPM. The input of the DC-DC converter is fixed to 50 V. The FER is significantly higher in the G3-PLC bandwidth (when the switching frequency of the DC-DC converter is in the range of 35–91 kHz), with a maximum value of around 60 kHz (i.e., the center frequency of the PLC bandwidth). However, the FER is not significant where the switching frequency of the DC-DC converter is out of the bandwidth of the G3-PLC. This result allows draw the conclusion that RPPM could only influence the G3-PLC when the switching frequency of the power converter is in the bandwidth of the G3-PLC system.

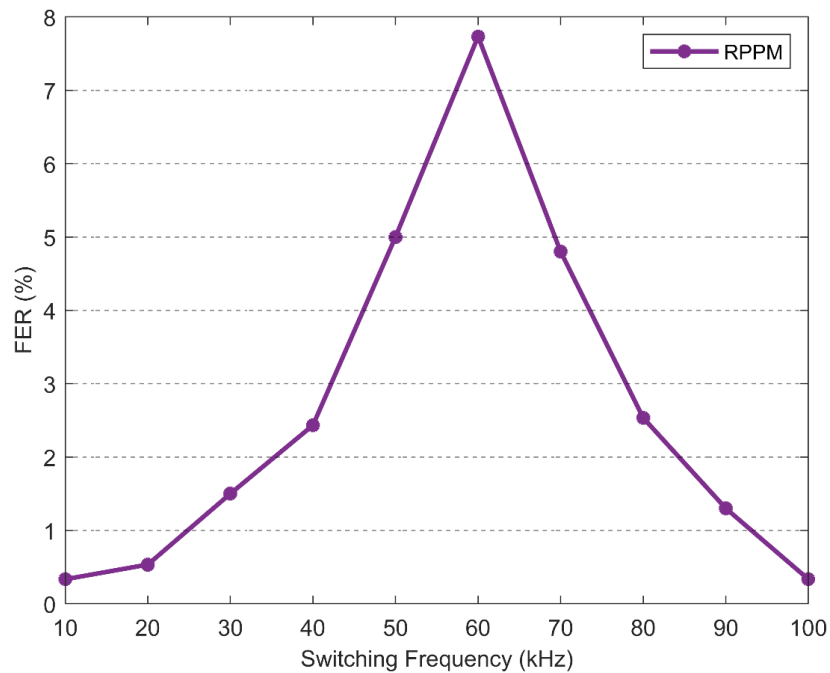
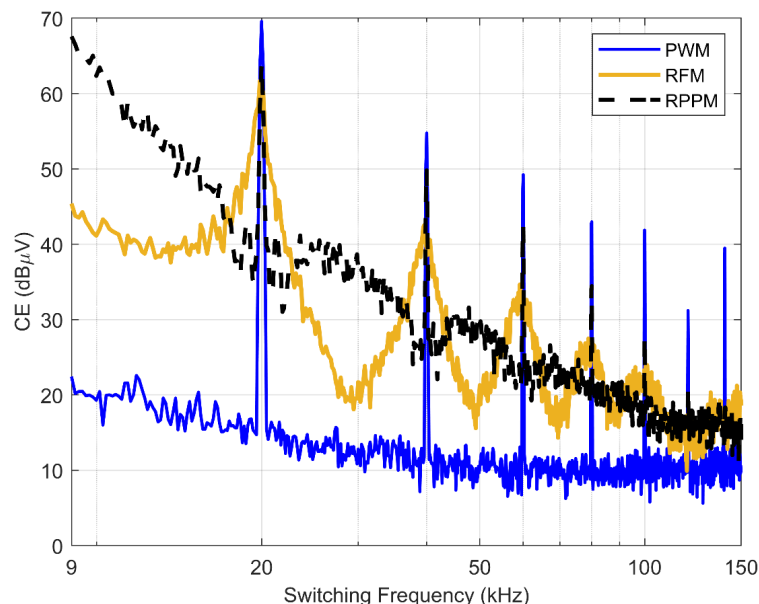


Figure 6. FER of the G3 PLC vs. switching frequency of the DC-DC converter modulated with RPPM.

A similar analysis involving RFM was carried out in [14], with the same input voltage of the DC-DC converter (50 V), and switching frequency varied from 50 to 75 kHz. Some of the results obtained in [14] are summarized in Table 3. The comparison allows appreciation of the fact that RFM (with 15–30% modulation index) causes significantly larger FER (more than 40%) compared to RPPM, with a maximum FER of 8% obtained at 20% modulation index (which is the maximum possible pulse position variation, as defined in (9)) around the intermediate switching frequency (60 kHz). Even with lower modulation indexes, RFM causes higher FER than RPPM. This is because the bandwidth of the noise generated by a DC-DC converter with RFM is wider (i.e., the noise is more spread) than with RPPM. This can be easily appreciated in Figure 7, where the CE exiting the same DC-DC converter driven by different modulation schemes (PWM, RFM, and RPPM at the 20 kHz switching frequency) are compared. The comparison unveils that even if RFM is more effective than RPPM for EMI reduction, RPPM offers significant advantages in terms of coexistence with communication systems. Of course, better performance of RFM can be obtained by adjusting the working parameters, i.e., by reducing the modulation index of RFM it is possible to have lower interference to the G3-PLC, but with lower CE reduction. This corroborates the conclusion that choosing the right modulation scheme is to be intended as a trade-off between EMI reduction and the coexistence issue.

**Table 3.** Comparison of the performance of G3-PLC assessed with RFM and RPPM applied to the DC-DC converter [14].

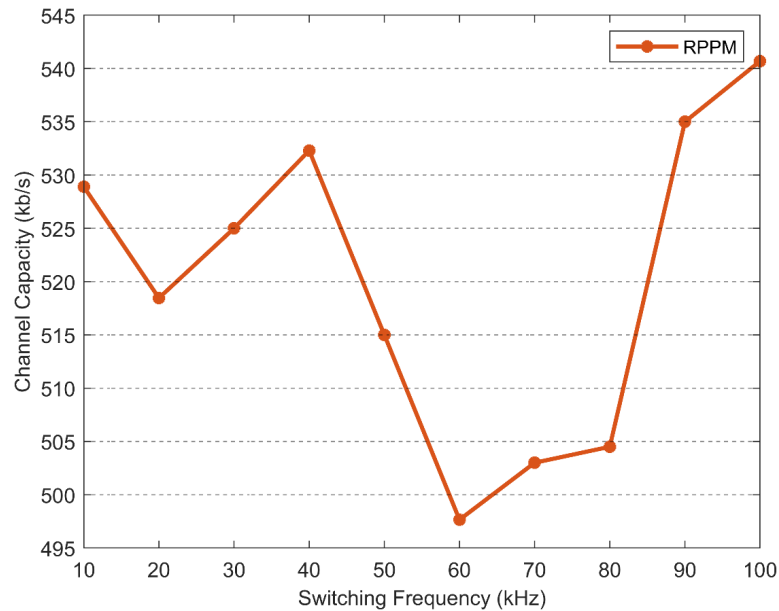
Frequency (kHz)	G3-PLC Performance					
	FER (%)		Channel Capacity (kb/s)		Channel Capacity Loss (%)	
	RFM	RPPM	RFM	RPPM	RFM	RPPM
60–63	50	8	390	498	48	18
50	8	5	460	515	40	16
75	4	3.5	370	503	50	17



**Figure 7.** Comparison of the CE exiting the same DC-DC converter driven by different modulation schemes.

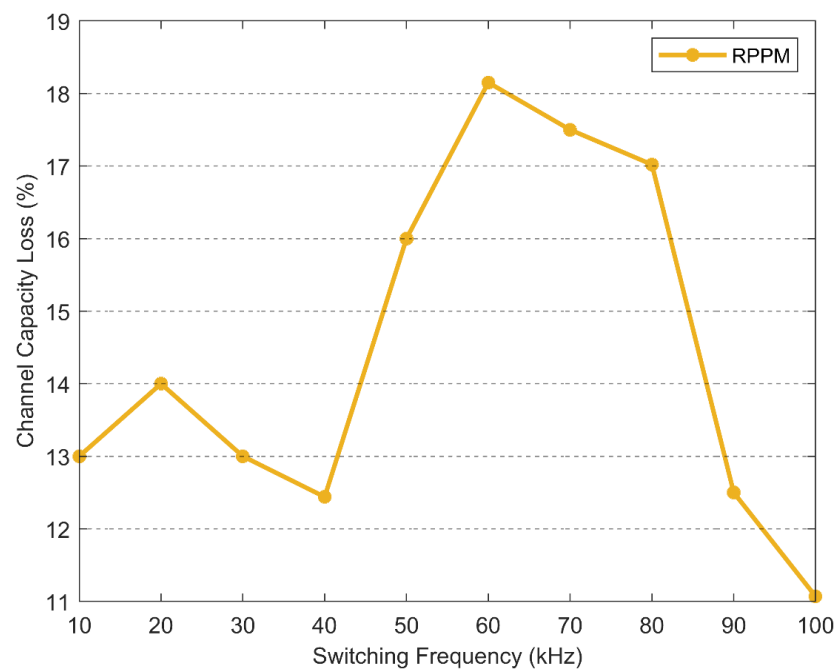
This conclusion is also confirmed when the Channel Capacity is considered. As depicted in Figure 8, the Channel Capacity of the G3-PLC reduces when the switching frequency of the converter is near the intermediate frequency of the G3-PLC system. However, for switching frequencies out of the bandwidth of the G3-PLC, the Channel Capacity is

not significantly affected. The worst Channel Capacity in the case of RPPM obtained is at switching frequencies around 60–63 kHz (498 kb/s) and results to be significantly higher than the minimum Channel Capacity obtained in [14] with the DC-DC converter driven by the RFM (390 kb/s at the spreading factor ‘ $\alpha = 30\%$ ’ and 63 kHz switching frequency).



**Figure 8.** Channel Capacity of the G3-PLC with different switching frequencies applied to the RPPM modulated DC-DC converter.

These observations are also confirmed in terms of Channel Capacity Loss. Indeed, Figure 9 shows that the G3-PLC Channel Capacity Loss takes maximum value (18%) at 60 kHz, which results to be significantly lower than the maximum Channel Capacity Loss (48%) observed in [14] for RFM (with spreading factor ‘ $\alpha = 30\%$ ’).



**Figure 9.** Channel Capacity Loss of the G3-PLC with different switching frequencies applied to the RPPM-modulated DC-DC converter.

### 5.2. Effects of Random Number Update Rate and Modulation Index

In this section, the effects of the RNUR and the modulation index of a randomly modulated power converter on the G3-PLC system are investigated.

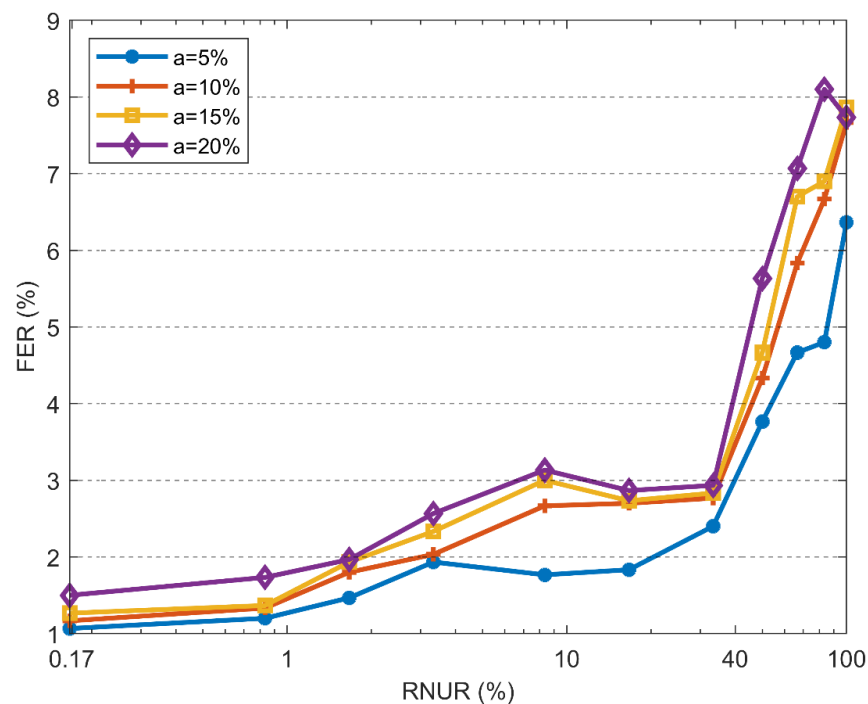
The RNUR of the random number (see Appendix A) plays a significant role on signal transmission because, with the higher RNUR of the random number, the pulse position of the RPWM changes rapidly.

The modulation index determines how much the pulse position could be varied with respect to the switching period. CE reduction is proportional to the modulation index because higher value result in higher reduction of the CE peak. Indeed, the maximum pulse position variation,  $\Delta_{max}$ , should be:

$$\Delta_{max} \leq (T - d) \quad (9)$$

Based on the results obtained in Section 5.1, to analyze the effects of the RNUR of the random number and the modulation index, three switching frequencies are chosen, in which one is around the intermediate frequency of the G3-PLC (60 kHz) where maximum disturbance due to random modulation is registered (see Section 5.1) and the other two are out of the frequency band of the G3-PLC (10 kHz and 100 kHz). A range of RNUR and modulation index values are considered to assess the performance of the G3-PLC.

Figure 10 shows the FER obtained when the switching frequency of the randomly modulated converter is 60 kHz, and the RNUR and the modulation index take values in the intervals 0.16–100% and 5–20%, respectively. The obtained result shows that the FER is directly proportional to both the RNUR and the modulation index. The FER increases when the RNUR and the modulation index increase. This result further confirms that there is a trade-off between EMI reduction and coexistence, i.e., increasing the modulation index helps in reducing the peaks of the converter CE (see Figure 11). However, it causes more disturbance to the G3-PLC.



**Figure 10.** FER of the G3 PLC measured with different values of RNUR and modulation index of the RPPM modulated DC-DC converter at 60 kHz switching frequency.

The Channel Capacity of the G3-PLC with respect to the RNUR and the modulation index is depicted in Figure 12. The Channel Capacity exhibits significant reduction when both the RNUR and the modulation index are increased. The reduction with the RNUR

is significant for large values of the modulation index. Conversely, for small modulation indexes, limited variations are observed. These results are also confirmed in terms of Channel Capacity Loss, as shown in Figure 13. Normally, the Channel Capacity Loss also increases with an increase in both the RNUR and the modulation index.

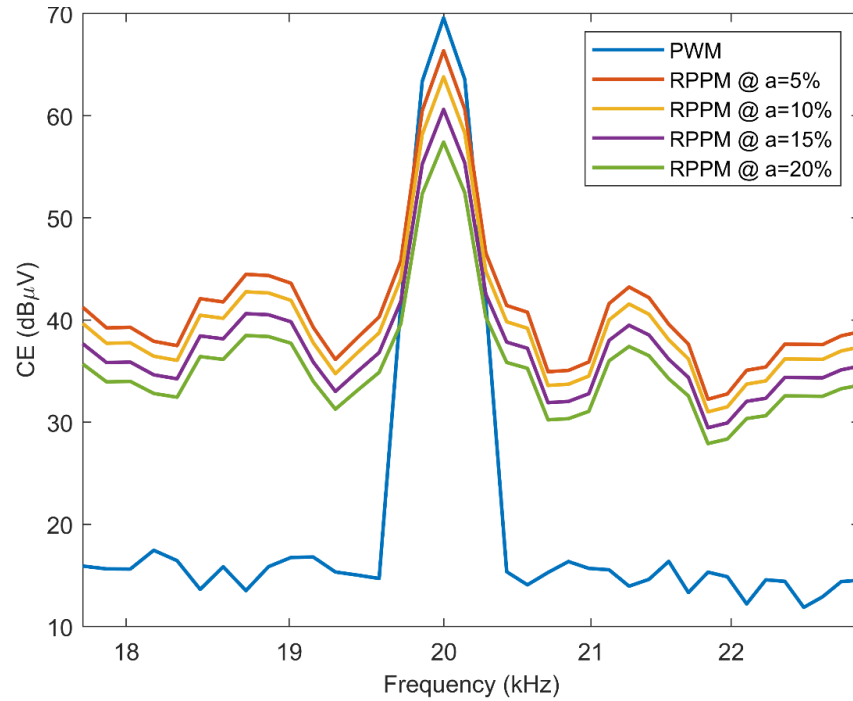


Figure 11. CE of the DC-DC converter measured with different values of the modulation index at 20 kHz switching frequency and at 33% RNUR.

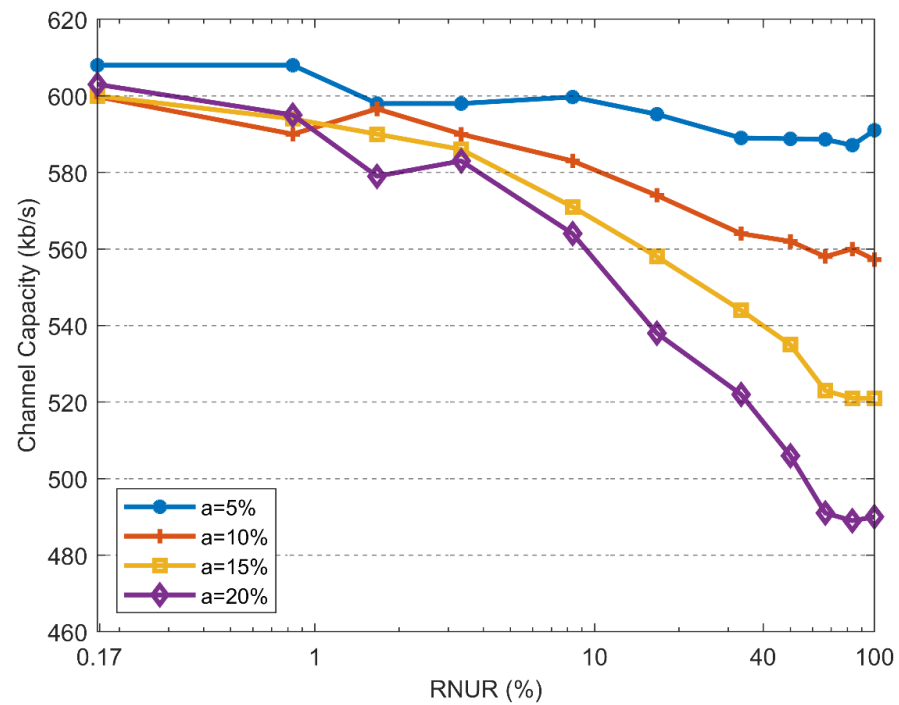
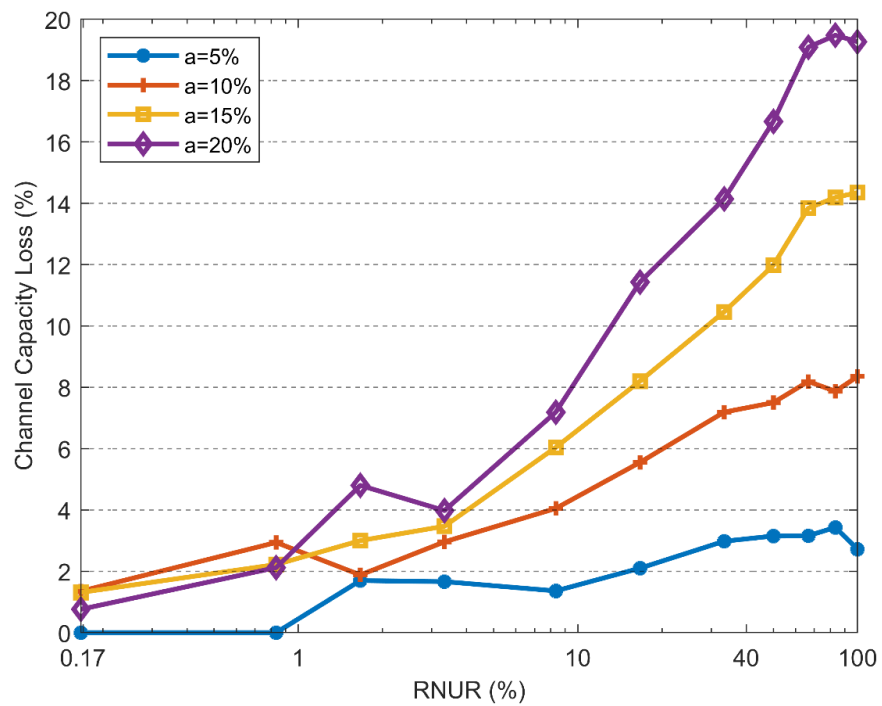
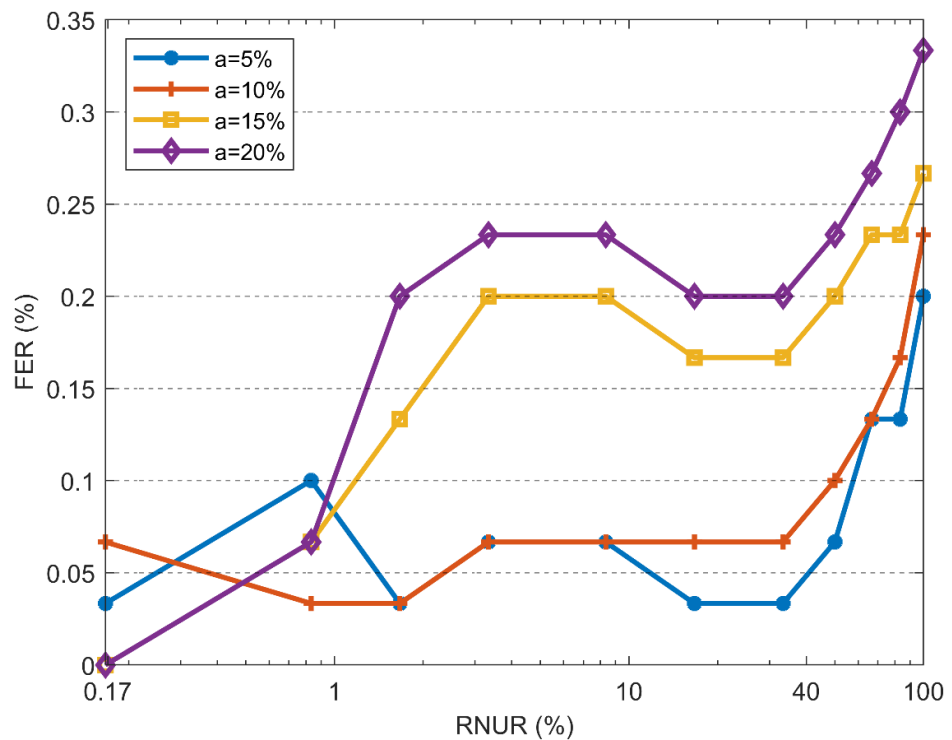


Figure 12. Channel Capacity of the G3 PLC measured with different values of the RNUR and the modulation index of the RPPM modulated DC-DC converter at 60 kHz switching frequency.

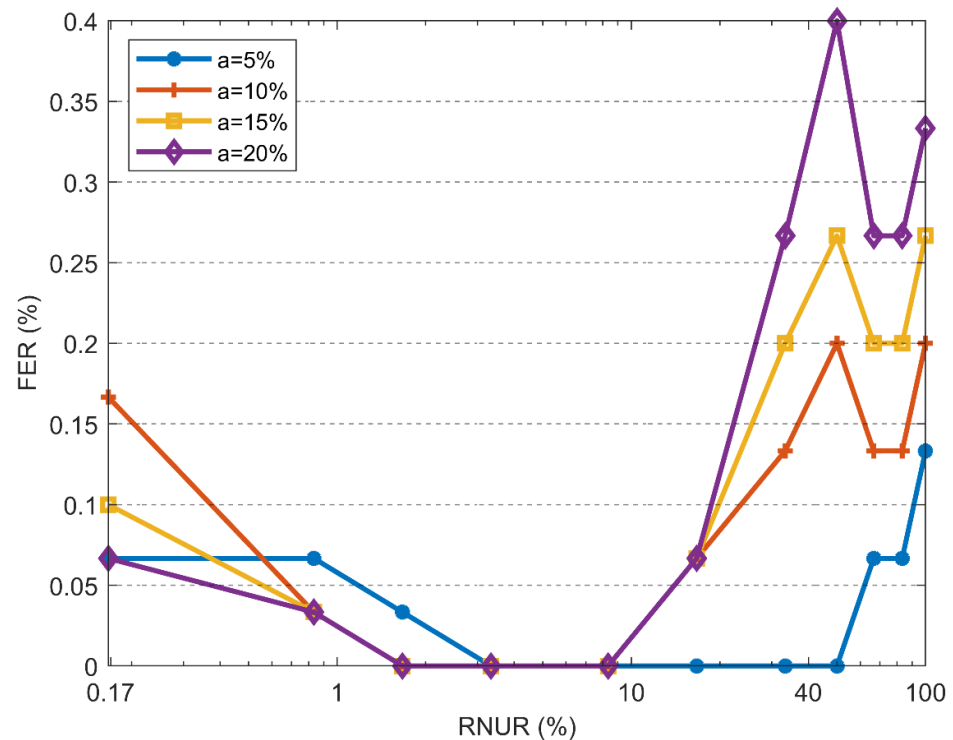


**Figure 13.** Channel Capacity Loss of the G3 PLC calculated with different values of the RNUR and the modulation index of the RPPM modulated DC-DC converter at 60 kHz switching frequency.

The performance of the G3-PLC for switching frequencies outside the PLC bandwidth are shown in Figures 14 and 15, respectively, confirming an increase in the FER when both the RNUR and the modulation index increase. However, the amount of variation in Figures 14 and 15 is insignificant compared to the results in Figure 10.



**Figure 14.** FER of the G3 PLC measured with different values of the RNUR and the modulation index of the RPPM modulated DC-DC converter at 10 kHz switching frequency.



**Figure 15.** FER of the G3 PLC measured with different values of the RNUR and the modulation index of the RPPM modulated DC-DC converter at 100 kHz switching frequency.

Therefore, it is possible to conclude that the RNUR and the modulation index of a randomly modulated power converter play a significant role in affecting the G3-PLC only when the switching frequency of the power converter overlaps with the bandwidth of the G3-PLC and is negligible for switching frequencies out of the bandwidth of the G3-PLC. This conclusion is confirmed also in terms of Channel Capacity and Channel Capacity Loss, whose plots are omitted for the sake of brevity.

## 6. Conclusions

In this paper, the coexistence between power and data lines in G3-PLC systems in the presence of randomly modulated power converters has been investigated. More specifically, among the available RPWM schemes, this work focused on RPPM. The effects of different parameters of an RPWM-scheme driving power converter (switching frequency, modulation index, and RNUR) on the G3-PLC are assessed by experiments. Communication performance is evaluated in terms of FER, Channel Capacity, and Channel Capacity Loss. The obtained results have confirmed that switching frequencies close to the bandwidth of the G3-PLC causes interference in the PLC system more than those out of the frequency bandwidth. The comparison versus similar results obtained by considering other RPWM techniques has showed that there is a trade-off between CE reduction and coexistence with communication systems. Namely, even if RPPM is not as effective as other schemes (as, for instance, RFM) in reducing the CE exiting the converter, this modulation scheme outperforms RFM in terms of coexistence with communication systems. Moreover, the effects of other RPWM parameters, such as the RNUR and the modulation index, on the PLC system have been experimentally examined to draw general conclusions on the effectiveness of RPWM in assuring coexistence. Results showed that the RNUR and the modulation index of RPPM have a direct effect on the communication channel. Indeed, the performance of the G3-PLC degrades with the increase in the RNUR and the modulation index. However, this is true only when the switching frequency of the randomly modulated converter overlaps with the bandwidth of the G3-PLC. Otherwise the effect is almost negligible.

Based on the experimental analysis, it is possible to draw two main conclusions. First, a randomly modulated power converter may deteriorate PLC performance when the converter switching frequency is near the bandwidth of the communication channel. The interference can be avoided or reduced to a minimum by choosing different/non overlapping frequency bands for the converters and/or the PLC systems. Another conclusion is that, among the available RPWM schemes, RPPM is less detrimental than RFM. Obviously, RFM may also result in less interference to the PLC if a lower modulation index is chosen, but with compromising CE reduction.

**Author Contributions:** Conceptualization, A.H.B., W.E.S., F.G. and P.S.C.; methodology, A.H.B., F.G., P.S.C. and W.E.S.; validation, A.H.B., W.E.S., L.W., F.G., P.S.C., A.M., X.L. and X.W.; formal analysis, A.H.B., W.E.S., L.W., F.G., P.S.C., X.L. and X.W.; investigation, A.H.B., W.E.S., F.G. and P.S.C.; resources, F.G., R.S. and S.A.P.; data curation, A.H.B. and W.E.S.; writing—original draft preparation, A.H.B. and F.G.; writing—review and editing, A.H.B., W.E.S., L.W., F.G., P.S.C., A.M., X.L., X.W., R.S. and S.A.P.; visualization, F.G., W.E.S. and P.S.C.; supervision, F.G., P.S.C., R.S. and S.A.P.; project administration, F.G.; funding acquisition, F.G. All authors have read and agreed to the published version of the manuscript.

**Funding:** This project has received funding from the European Union’s Horizon 2020 research and innovation program under the Marie Skłodowska-Curie grant agreement No. 812753.

**Informed Consent Statement:** Not applicable.

**Data Availability Statement:** Not applicable.

**Conflicts of Interest:** The authors declare no conflict of interest.

## Appendix A

RPPM can be generated using a C2000 TI microcontroller and MATLAB SIMULINK. For conventional PWM, the ePWM module in SIMULINK can be programmed as follows, and the details can be inferred from [26,27]:

$$TBPRD = TPWM / 2TBCLK \quad (A1)$$

and

$$CMPA = (1 - D) \times TBPRD \quad (A2)$$

where TBCLK is the Time-Base Clock, TBPRD is the Time-Base Period; TPWM is the period of the PWM, and CMPA and CMPB are the references-comparing A and B values.

However, the implementation of RPPM is somewhat more complex. In this case, controlling the CMPA and CMPB reference values according to (A3) and (A4) is required.

$$CMPB' = CMPB + \Delta CMPB \times RAND \quad (A3)$$

and

$$CMPA = 2 \times TBPRD - CMPB' - (D \times 2 \times TBPRD) \quad (A4)$$

where RAND is a pseudo-random number between 1 and  $-1$ , CMPB' is the random CMPB value, D is the duty cycle, and  $\Delta CMPB$  is the change in CMPB reference. The randomization factor,  $\alpha$ , or modulation index can be expressed as:

$$\alpha = \Delta CMPB / TBPRD \quad (A5)$$

Note that the UP/Down counter should be selected where CMPB UP is 'Set' and CMPA DOWN is 'Clear' for this specific RPPM set up. The random PWM starts when the counter counts up and reaches the CMPB reference and stops when the counter counts down and reaches the CMPA value. The SIMULINK model implemented for the specific RPPM considered in this paper is shown in Figure A1.

The Uniform Random Number block generates uniformly distributed random numbers over an interval between 1 and  $-1$ . The time interval between samples is the sampling time ( $T_s$ ).

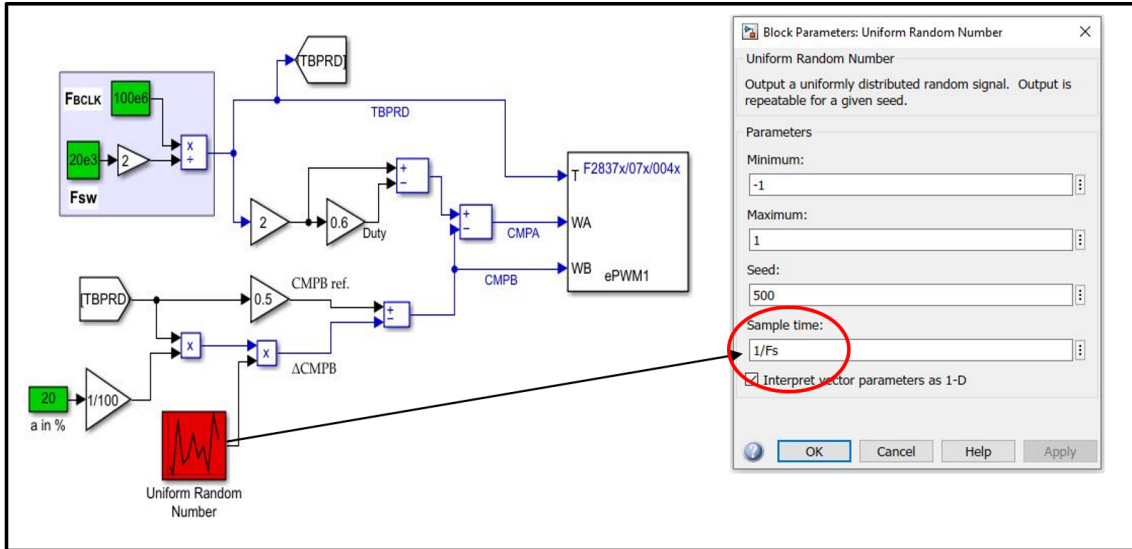


Figure A1. SIMULINK schematics of the implemented RPPM.

Random Number Repetition (RNR) is the number of periods of the RPWM within the same random number. RNP can be expressed as:

$$RNR = \frac{T_s}{TRPWM} \tag{A6}$$

where  $T_s$  is the sampling time of the random number generator SIMULINK block (see Figure A1) and  $TRPWM$  is the period of the RPWM signal. For example, in Figure A2, the pulse position changes after two consecutive periods of the RPWM signal ( $RNR = 2$ ). In general, the higher the RNR, the lower the pulse position variation.

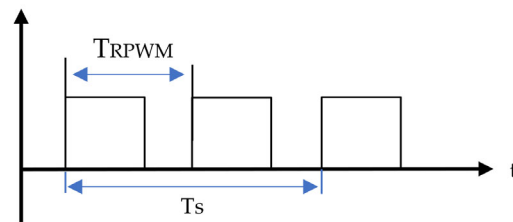


Figure A2. The RPWM signal.

The Random Number Update Rate (RNUR) is the rate of the switching period over one sampling time,  $T_s$ , and can be expressed as:

$$RNUR = \frac{TRPWM}{T_s} \tag{A7}$$

To obtain the pulse position variation of the RPWM signal, the sampling time,  $T_s$ , should be greater than or equal to the period of the RPWM. Therefore, the value of  $RNUR$  is  $\leq 1$ . In general, the higher the  $RNUR$ , the more pulse position variation repetitions of the RPWM signal.  $RNUR$  can also be expressed in percentage as:

$$RNUR = \frac{TRPWM}{T_s} \times 100 \tag{A8}$$

## References

1. Ancillotti, E.; Bruno, R.; Conti, M. The role of communication systems in smart grids: Architectures, technical solutions and research challenges. *Comput. Commun.* **2013**, *36*, 1665–1697. [CrossRef]
2. Kabalci, Y. A survey on smart metering and smart grid communication. *Renew. Sustain. Energy Rev.* **2016**, *57*, 302–318. [CrossRef]
3. Uribe-Pérez, N.; Angulo, I.; De la Vega, D.; Arzuaga, T.; Fernández, I.; Arrinda, A. Smart Grid Applications for a Practical Implementation of IP over Narrowband Power Line Communications. *Energies* **2017**, *10*, 1782. [CrossRef]
4. Sendin, A.; Simon, J.; Urrutia, I.; Berganza, I. PLC deployment and architecture for Smart Grid applications in Iberdrola. In Proceedings of the 18th IEEE International Symposium on Power Line Communications and Its Applications, Glasgow, UK, 30 March–2 April 2014; pp. 173–178.
5. Khan, M.S.; Ahmed, T.; Aziz, I.; Alam, F.B.; Bhuiya, M.S.U.; Alam, M.J.; Chakma, R.; Mahtab, S.S. PLC Based Energy-Efficient Home Automation System with Smart Task Scheduling. In Proceedings of the 2019 IEEE Sustainable Power and Energy Conference (iSPEC), Beijing, China, 21–23 November 2019; pp. 35–38.
6. Ngcobo, T.; Ghayoor, F. Study the Topology Effect on a G3-PLC based AMI Network. In Proceedings of the 2019 Southern African Universities Power Engineering Conference/Robotics and Mechatronics/Pattern Recognition Association of South Africa (SAUPEC/RobMech/PRASA), Bloemfontein, South Africa, 28–30 January 2019; pp. 629–633.
7. Barmada, S.; Raugi, M.; Tucci, M.; Maryanka, Y.; Amrani, O. PLC systems for electric vehicles and Smart Grid applications. In Proceedings of the 2013 IEEE 17th International Symposium on Power Line Communications and Its Applications, Johannesburg, South Africa, 24–27 March 2013; pp. 23–28.
8. El Sayed, W.; Loschi, H.; Smolenski, R.; Lezynski, P.; Lok, C.L. Performance Evaluation of the Effect of Power Converters Modulation on Power line Communication. In Proceedings of the Sterowaniew Energoelektronicei Napedzie Elektrycznym (SENE), Łódź, Poland, 20–22 November 2019.
9. Pareschi, F.; Rovatti, R.; Setti, G. EMI Reduction via Spread Spectrum in DC/DC Converters: State of the Art, Optimization, and Tradeoffs. *IEEE Access* **2015**, *3*, 2857–2874. [CrossRef]
10. Tse, K.K.; Chung, H.S.; Huo, S.Y.; So, H.C. Analysis and spectral characteristics of a Spread-Spectrum technique for conducted EMI suppression. *IEEE Trans. Power Electron.* **2000**, *15*, 399–410. [CrossRef]
11. Kumar, A.C.B.; Narayanan, G. Variable switching frequency PWM Technique for Induction Motor Drive to Spread Acoustic Noise Spectrum with reduced current ripple. *IEEE Trans. Ind. Appl.* **2016**, *52*, 3927–3938. [CrossRef]
12. Sayed, W.E.; Lezynski, P.; Smolenski, R.; Madi, A.; Pazera, M.; Kempski, A. Deterministic vs. *Random Modulated Interference on G3 Power Line Communication*. *Energies* **2021**, *14*, 3257. [CrossRef]
13. Niewiadomski, K.; Smolenski, R.; Lezynski, P.K.; Bojarski, J.; Thomas, D.W.P.; Blaabjerg, F. Comparative Analysis of Deterministic and Random Modulations Based on Mathematical Models of Transmission Errors in Series Communication. *IEEE Trans. Power Electron.* **2022**. [CrossRef]
14. Sayed, W.E.; Lezynski, P.; Smolenski, R.; Moonen, N.; Crovetto, P.; Thomas, D.W.P. The Effect of EMI Generated from Spread Spectrum-Modulated SiC-Based Buck Converter on the G3-PLC Channel. *Electronics* **2021**, *10*, 1416. [CrossRef]
15. Musolino, F.; Crovetto, P.S. Interference of Spread-Spectrum Switching-Mode Power Converters and Low-Frequency Digital Lines. In Proceedings of the 2018 IEEE International Symposium on Circuits and Systems (ISCAS), Florence, Italy, 27–30 May 2018; pp. 1–5. [CrossRef]
16. Beshir, A.H.; Wan, L.; Grassi, F.; Crovetto, P.S.; Liu, X.; Wu, X.; El Sayed, W.; Spadacini, G.; Pignari, S.A. Electromagnetic Interference of Power Converter with Random Modulation on the Power Line Communication System. *Electronics* **2021**, *10*, 2979. [CrossRef]
17. Trzynadlowski, A.M.; Blaabjerg, F.; Pedersen, J.K.; Kirilin, R.L.; Legowski, S. Random pulse width modulation techniques for converter-fed drive systems—a review. *IEEE Trans. Ind. Appl.* **1994**, *30*, 1166–1175. [CrossRef]
18. Stankovic, A.M.; Verghese, G.C.; Perreault, D.J. Analysis and synthesis of randomized modulation schemes for power converters. *IEEE Trans. Power Electron.* **1995**, *10*, 680–693. [CrossRef]
19. Stanković, A.M.; Lev-Hari, H. Randomized modulation in power electronic converters. *Proc. IEEE* **2002**, *90*, 782–799. [CrossRef]
20. Bech, M.M. Analysis of Random Pulse-Width Modulation Techniques for Power Electronic Converters. Ph.D. Thesis, Aalborg University, Aalborg, Denmark, 2000. Available online: [https://vbn.aau.dk/ws/portalfiles/portal/316407375/michael\\_m\\_bech.pdf](https://vbn.aau.dk/ws/portalfiles/portal/316407375/michael_m_bech.pdf) (accessed on 15 October 2021).
21. Lopez, G.; Matanza, J.; De La Vega, D.; Castro, M.; Arrinda, A.; Moreno, J.I.; Sendin, A. The role of power line communications in the smart grid revisited: Applications challenges and research initiatives. *IEEE Access* **2019**, *7*, 117346–117368. [CrossRef]
22. Lavenu, C.; Chauvenet, C.; Treffiletti, P.; Varesio, M.; Hueske, K. Standardization Challenges, Opportunities and Recent Evolutions for the G3-PLC Technology. *Energies* **2021**, *14*, 1937. [CrossRef]
23. G3-PLC User Guidelines. Available online: <https://g3-plc.com/g3-plc/specifications-user-guidelines/> (accessed on 25 October 2021).
24. Razazian, K.; Umari, M.; Kamalizad, A.; Loginov, V.; Navid, M. G3-PLC specification for powerline communication: Overview, system simulation and field trial results. In Proceedings of the ISPLC2010, Rio de Janeiro, Brazil, 28–31 March 2010; pp. 311–318. [CrossRef]
25. Musolino, F.; Crovetto, P.S. Interference of Spread-Spectrum Modulated Disturbances on Digital Communication Channels. *IEEE Access* **2019**, *7*, 158969–158980. [CrossRef]

- 
26. Santra, S.B.; Bhattacharya, K.; Chudhury, T.R.; Chatterjee, D. Generation of PWM Schemes for Power Electronic Converters. In Proceedings of the 2018 20th National Power Systems Conference (NPSC), Tiruchirappalli, India, 14–16 December 2018; pp. 1–6. [[CrossRef](#)]
  27. Datasheet TMS320F28379D Texas Instruments. Available online: <http://www.ti.com/lit/ds/symlink/tms320f28374d.pdf> (accessed on 28 July 2021).