

Multi-objective Optimization Methods for Passive and Active Devices in mm-Wave 5G Networks

Original

Multi-objective Optimization Methods for Passive and Active Devices in mm-Wave 5G Networks / Kouhalvandi, L., Matekovits, L. (POLITO SPRINGER SERIES). - In: Printed Antennas for 5G Networks / Matekovits L., Kanaujia B. K., Kishor J., Gupta S. K.. - STAMPA. - [s.l.] : Springer Science and Business Media Deutschland GmbH, 2022. - ISBN 978-3-030-87604-3. - pp. 337-371 [10.1007/978-3-030-87605-0_12]

Availability:

This version is available at: 11583/2962335 since: 2022-05-13T19:13:05Z

Publisher:

Springer Science and Business Media Deutschland GmbH

Published

DOI:10.1007/978-3-030-87605-0_12

Terms of use:

This article is made available under terms and conditions as specified in the corresponding bibliographic description in the repository

Publisher copyright

Springer postprint/Author's Accepted Manuscript (book chapters)

This is a post-peer-review, pre-copyedit version of a book chapter published in Printed Antennas for 5G Networks. The final authenticated version is available online at: http://dx.doi.org/10.1007/978-3-030-87605-0_12

(Article begins on next page)

Multi-objective Optimization Methods for Passive and Active Devices in mm-Wave 5G Networks

Lida Kouhalvandi^{1,2+}[0000-0003-0693-4114] and Ladislau Matekovits^{2,3,4#}[0000-0003-0946-9561]

¹ Electronics and Communication Engineering Department, Istanbul Technical University, 34467, Istanbul, Turkey

² Department of Electronics and Telecommunications, Politecnico di Torino, 10129 Torino, Italy

³ Faculty of Electronics and Telecommunications, Politehnica University Timisoara, 300223 Timisoara, Romania

⁴ Istituto di Elettronica e di Ingegneria dell'Informazione e delle Telecomunicazioni, National Research Council, 10129 Turin, Italy

kouhalvandi@itu.edu.tr⁺, ladislau.matekovits@polito.it[#]

Abstract. Due to the exponential growth of data communications, millimeter -wave (mm-Wave) new radio specification becomes key enablers for fifth generation (5G) communication systems. However in the mm-Wave band frequency, the propagation loss is intensively large and cannot cover all the determined specifications. To tackle this drawback, the transceiver parts must sense the high radiated output power from power amplifiers. Hence by using high performance wideband antennas, the amplifiers can facilitate massive multiple-input multiple-output (MIMO) 5G systems. The figure of merit (FoM) of an amplifier is determined by the output power that must be challenged by other design specifications as: power gain, drain efficiency, and linearity. Therefore, powerful multi-objective optimization methods are required for welcoming appointed passive (antennas) and active (power amplifiers) characteristics in the determined frequency band. On the other side, high performance antennas in the 5G networks are also needed that can be designed using potent optimization methods. In this chapter, we provide collection of various optimization methods which have been recently applied for designing and optimizing high performance high power amplifiers and antennas. Hence, any designer can access to the nominated algorithms and can select the ones that are suitable for their problems.

Keywords: Algorithm · Antenna · Fifth generation (5G) · Multi-objective optimization · Printed antennas · Power amplifier (PA).

1 Introduction

Fifth generation (5G) communication systems are growing rapidly in modern devices due to the necessity for multi-gigabit per second (Gb/s) cellular connectivity [1]. For 5G applications, the international telecommunication union (ITU)

has determined at least 500 MHz bandwidth and wideband spectrum-efficient modulations (like 64- and 256-quadrature amplitude modulation (QAM)) [2]. Generally, the millimeter-wave (mm-Wave) bands for developing 5G are around 28, 39, and 45 GHz that are leading to increase requirements for higher data rates.

The mm-Wave technology requires high performance 5G antennas and wide-band multiple-input and multiple-output (MIMO) technology for constructing ultradense networks. In these networks, the amount of output power (P_L) can have significant influences on achieving suitable isotropic radiated power. Hence for supporting future 5G networks, power amplifiers (PAs) play an important role in arranging the P_L response. This specification influences other PA characteristics as efficiency, bandwidth, power gain, and linearity (i.e., amplitude modulated (AM) and phase modulated (PM) signals). Designing high performance PAs with the nominated specifications is not straightforward and requires powerful effort and experiences. Conventional electronic design automation (EDA) tools such as ADS, AWR, and HSS [3] are useful software including some optimization methods. These methods are appropriate for optimizing linear and nonlinear circuits; however, when the dimensional of data is becoming huge and the complexity of circuit is increasing additional optimization methods are required [3].

The PAs have nonlinear behavior in the operation frequency band because of included transistors such as gallium nitride (GaN) high-electron-mobility transistor (HEMT), gallium arsenide (GaAs) HEMT, and LDMOS (laterally-diffused metal-oxide semiconductor) transistors. These nonlinearities occur due to the design architecture and also due to the harmonic effects of used transistors. Concurrently, optimizing nonlinear functions such as P_L , power gain (G_p), drain efficiency (η_D), and also adjacent channel power ratio (ACPR) specifications are not straightforward and requires multi-objective optimization methods. If a satisfied P_L is achieved from PAs, in the general configuration of communication systems flexible joint communication can be appeared resulting in enabling MIMO 5G systems.

Beside of optimizing PAs, designing high performance antennas is an essential necessity. Therefore, multi-objective optimization methods are required to challenge and deal with the large amount of data generated during the design of microwave circuits to satisfy the input constrains and design goals [4]. By paying attention to the limitations in the multiple features and the existed configurations, multi-objective optimization methods are growing exponential to improve especial characteristics in communication systems. Generally, the optimization attempts to find an optimal solution that makes the problem as effective as possible. Hence, multi-objective optimization determines the best solution among various objectives and constraints.

This chapter provides an overview over the recently employed optimization methods for designing and optimizing high performance PAs and antennas that can generate high output power and high flat gain, respectively. Additionally, various optimization methods for simultaneously optimizing PA's design specifications have also been described in detail by defining the theory and real

implementation of each method. Any researcher, by considering his/her system configurations, can decide the best and suitable optimization method(s) to reach the desired goals.

This chapter is organized as follows: Section 2 is devoted to explain the background of optimization methods and their importance in the communication systems. Section 3 provides the purpose and motivation of optimization methods in microwave designs. Various employed optimization algorithms in the design of power amplifiers and antennas are summarized in Sec. 4. Finally, Sec. 5 concludes this chapter.

2 Background

In the recent years, modern wireless communication systems include 5G antennas face with drawbacks related to transferring data among various components. As described in Section 1, employing high performance high power amplifiers in communication systems is critical since the output power of any PA directly influences the radiation through 5G antennas. Therefore, designing and optimizing PAs that result in satisfied design specifications in terms of P_L , G_p , η_D , and linearity are essential and important. The PAs include active components such as GaN and GaAs HEMTs with passive components in the input matching network (MN), output MN, and also in the biasing networks as shown in Fig. 1. The performance of PA depends on the quality factor (Q) of included components, circuit topology, and harmonic effects of used transistors.

Commercial electronic design automation (EDA) software tools such as ADS and AWR, are beneficial in microwave circuit optimizations. However, in RF and microwave field the space of design parameters is huge and these tools cannot fulfill all the requirements. On the other hand, optimizing concurrently the design specifications of PAs and antennas, is not straightforward and EDA tools can not support all stipulations. Generally, these optimizations are performed manually by designers and the circuit designs depend mostly on the engineer's experience.

In summary, the need of advanced multi-objective optimization methods becomes essential today and designers present modern algorithms for designing high performance PAs and antennas that various design specifications are trading-off among each other.

3 Target and motivation of optimization methods in the microwave field

As explained above, the optimization methods play significant roles in the engineering and assist engineers to design and optimize high performance circuits. This section provides transparent explanations about the definition, general structures of various optimization methods, and the motivation of using these methods in power amplifier and antenna designs.

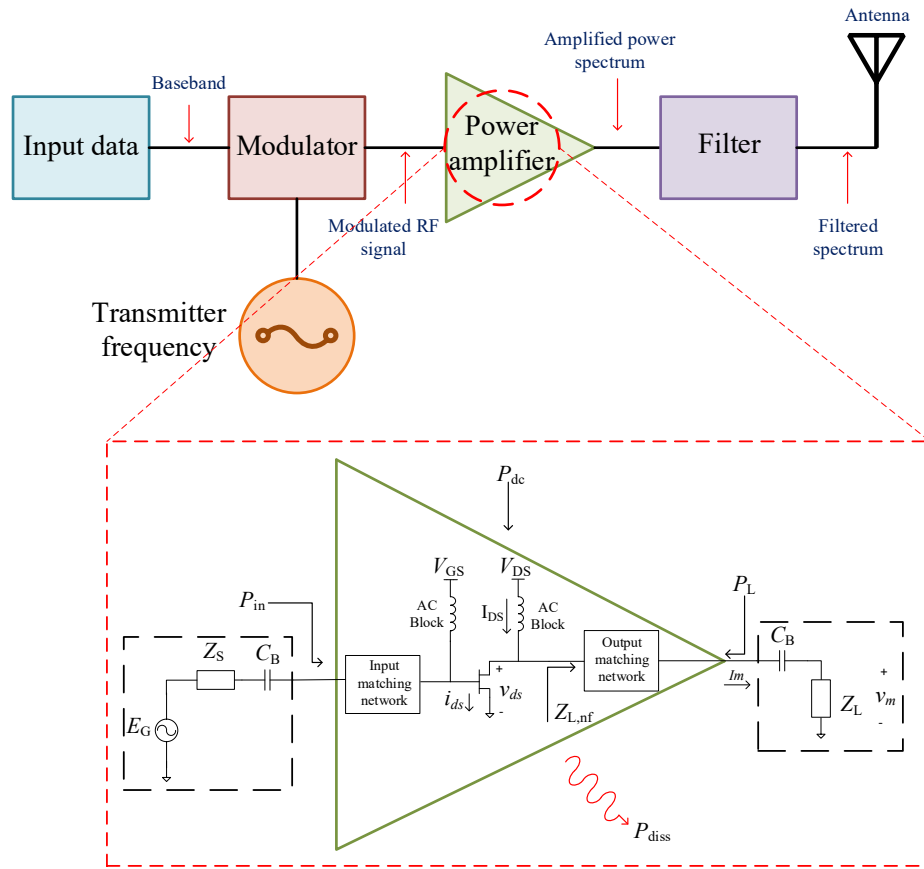

Fig. 1. The general structure of communication systems includes a power amplifier and an antenna.

3.1 Definition of optimization

The difference between the technological design process and the engineering design process is the optimization process. Mathematically, the optimization term refers to procedures for finding the optimal solutions of functions in various conditions, here described as systems and circuits. The optimal values of single/multiple functions with various variables are determined by considering the set of constrains. Herein, mathematical models are employed to help engineers predicting design parameters and are used for minimizing design cost with maximizing system performance. In configuring systems and networks, the initial guess of design parameters are determined then parameter values are optimized with respect to the interrelationships between various specifications.

Any optimization process can be either applied to a single-objective or a multi-objective function. Generally, the mathematical formulation for optimization problems can be defined as (1),

$$\left\{ \begin{array}{l} \text{minimize } f(x); \quad f(x) \in R^m \\ \text{subject to } g(x) \leq 0; \quad g(x) \in R^k \\ x \in \Omega \end{array} \right\} \quad (1)$$

where the general description for the defined parameters in (1) are as follows:

- f_x : Vector with m objective functions;
- g_x : Vector with k constraints;
- x : Vector with n design variables on the search space Ω .

The quantity m represents that the function is either single-objective or multi-objective optimization: $m=1$ and $m>1$ define single-objective and multi-objective optimizations, respectively.

3.2 Configuration of optimization

Providing accurate flowchart and structure for designing and optimizing any circuit and system is one of the critical steps. Based on this, designers attempt to find the best optimization solvers that can find the response to their problems easily. Engineers firstly find various design solutions and then select which of the methods will provide the best results for their circuits. After picking the best solution, optimization methods and algorithms are performed for achieving the optimal solution.

In the engineering domain, the optimization process is mainly applied for three targets namely: size optimization, shape optimization, and topology optimization. Firstly, any designer must determine that for what purpose the optimization is performed (i.e., size, shape, and/or topology). Then, the design parameters are selected and the optimization algorithms are determined based on the complexity of the problems at system level design. Finally, the identified algorithms are employed for achieving satisfied design specifications with the best parameter values. Figure 2 shows the general optimization flow in the engineering field. Simply, the optimization process is a systematic process where design constraints and criteria are applied to achieve the optimal solutions in terms of various specifications such as productivity, strength, and utilization.

3.3 Need of optimization process

Optimization methods are useful from various perspectives as: developing effectiveness, improving quality, and reducing design cost. Typically, algorithms estimate the direction of improvement and can decide the optimum conditions for the performed process. The most accurate responses and solutions can be achieved by employing mathematical knowledge to properly select the right model and the most appropriate optimization tool to reduce as much as possible the required number of iterations.

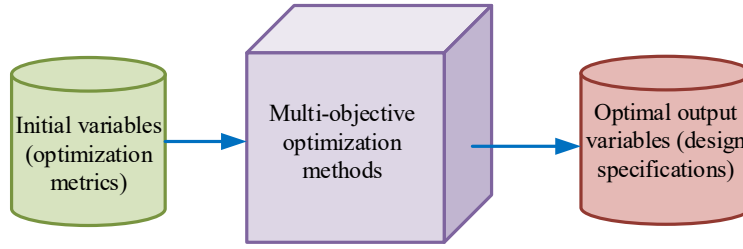

Fig. 2. General structure of optimization process.

3.4 Use of power amplifiers and antennas in the communication systems

As Fig. 1 shows, the communication systems involve two important structures namely as: power amplifier (active device) and antenna (passive device). This section provides the general explanations regarding the design and optimization of amplifiers and antennas.

High performance power amplifier design and optimization

Tuning harmonic impedances can improve the efficiency performance of various classes of PAs. To generate 100% efficiency, voltage and current waveforms must not be overlapped as Fig. 3 depicts. The maximum efficiency is generated when there is no knee voltage (V_k) at different harmonics; hence, the power is not wasted as heat. Ideally and theoretically, the efficiency in class-F, F^{-1} , J, and E is 100% and in other types as in class-A, AB, B, and C efficiency can be achieved as 50%, 50-78%, 78.5%, >78.5%, respectively [5].

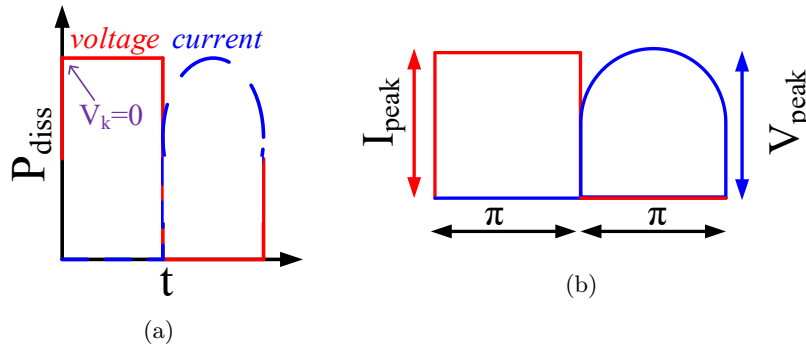

Fig. 3. a) Ideal waveforms for PAs; b) Peak magnitudes of current and voltage with rectangular current and half-sinusoidal voltage.

The general equation for drain efficiency (η_D (%)) is shown in (2). As Fig. 3.b shows, the η_D can be 100% when the fundamental voltage and current have

peak magnitudes. Herein, the maximum efficiency occurs for $\frac{I_{peak}}{I_{DC}} = \frac{4}{\pi}$ and $\frac{V_{peak}}{V_{DC}} = \frac{\pi}{2}$ drain (or collector) in (2).

$$\eta = \frac{1}{2} \frac{V_{peak}}{V_{DC}} \quad (2)$$

As shown in Fig. 1, the parameters that influence η_D are drain voltage (v_{ds}) and drain current (i_{ds}). In terms of power, equation (2) can be formulated as (3)

$$\eta_D = \frac{P_{L,1f}}{P_{DC}} \quad (3)$$

where

$$P_{DC} = P_{diss} + P_{L,1f} + \sum_{n=2}^{\infty} P_{L,nf} = \frac{1}{T} \int_0^T v_{ds}(t) \cdot i_{ds}(t) dt + P_{L,1f} + \sum_{n=2}^{\infty} P_{L,nf} \quad (4)$$

For (4) the general descriptions are as: $P_{L,1f}$ is the output power at the fundamental frequency while $P_{L,nf}$ represents output powers at different harmonics n . Hence as much as dissipated heat power (p_{diss}) is reduced, $P_{L,nf}$ is increased and the drain efficiency can be enhanced.

Afterwards, the G_p can be explained as (5) where the P_L is the power delivered to a load and P_{in} is the available power of the generator. Therefore, by increasing P_L the gain performance is increased as well.

$$G_P = \frac{P_L}{P_{in}} \quad (5)$$

In PA designs, it is also desired to minimize phase distortion (AM/PM). Therefore, various studies are presented around enhancing linearity without worsening other design specifications such as efficiency and power gain [6,7]. As reported in [8], the phase distortion depends on the variation of device's input impedance. Figure 4 shows the simplified PA after applying Miller approximation [9].

In the equivalent circuit of PA, the input MN is presented with the impedance of $Z_S = R_S + jX_S$, the output MN is explained by

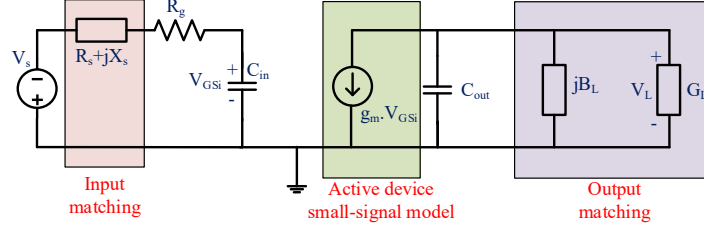

Fig. 4. Simplified power amplifier. V_s : Signal source, R_g : Input resistance, C_{in} : Input capacitor, C_{out} : Output capacitor.

admittance of $Y_L = G_L + jB_L$, and the active device is simplified by $g_m \cdot V_{GSi}$. The expressions of C_{in} and C_{out} are presented in (6)-(7).

$$C_{in} = C_{gs} + C_{gd} \cdot (1 + g_m/G_L) \quad (6)$$

$$C_{out} = C_{ds} + C_{gd} \cdot (1 + G_L/g_m) \quad (7)$$

Hence, the voltage amplification can be expressed as (8), and the phase of the output voltage is described in (9).

$$A_v = V_L/V_{GSi} = -g_m/G_L \quad (8)$$

$$\angle V_L = \tan^{-1}\left(\frac{R_s + R_g}{X_s - \frac{1}{\omega C_{in}}}\right) \quad (9)$$

By considering eq. (9), it can be realized that the linearity, or in other words the phase distortion, of PAs depends on the nonlinear parameters g_m , C_{gd} , C_{gs} , C_{ds} , and also on the output conductance (G_L).

High performance antenna design and optimization

In the field of communication the printed antenna is known as a microstrip antenna where during the fabrication usually photolithographic techniques is employed on a printed circuit board (PCB). Recently, researchers attempt to design and optimize printed antennas in the application of 5G and future sixth generation (6G) technologies since they are:

- Inexpensive in fabrication;
- Suitable to be used in the ultra high frequency (UHF);

- Powerful in a directive gain;
- Appropriate to result in high flat gain in single antenna and also array configurations;
- Flexible in an array form and able to be a phased array of antenna that includes beam-forming ability.

When designing antennas, optimization methods generally target size optimization, shape optimization, and/or topology optimization. These optimizations are performed to optimize the dimensions, shapes or geometry of the antenna structures, respectively. Therefore, it is necessary to determine suitable optimization approaches for one or all of the intentions that lead to improve output responses. Over the past decade, various optimization methods have been applied to optimize and design printed and patched antennas.

In [10], time-to-market solution for reducing the production time in patch antenna designs is presented which is based on the inkjet printing to fabricate emitters. Respectively, in another work ([11]) an optimization method is presented for employing it in the inkjet printing of RF structures. This procedure is applied by using one typical cardboard paper material as a substrate and a silver nanoparticle ink as the conductor which results in implementing microwave circuits on ultra-low-cost highly fibrous substrates. The antenna's geometries with layer thickness are optimized in [12] where in detail, the control of the conductor thickness with the concentrating ink only by using coplanar waveguide (CPW) and two antennas, are discussed. It is proved that by applying the presented method with one layer, the antenna can be printed and satisfactory output performance can be achieved.

4 Practical application of optimization algorithms in the design of high performance power amplifiers and antennas

The following description provides in detailed presentation of the various applied optimization methods for designing high performance power amplifiers and antennas that are suitable for 5G networks.

4.1 Bottom-Up Optimization (BUO)

The bottom-up optimization (BUO) method is the process of piecing the system into sub-blocks, similarly to domain decomposition.

In this method, the system and circuit are decomposed into several hierarchical levels. The optimization process starts with the lowest level and the decomposed levels are increased sequentially and hierarchically. This method continues increasing until achieving either the system-level or circuit-level with suitable output performance.

System-level: This methodology has been recently applied in various RF circuits. Typically, multi-objective optimization algorithms are used and the information is passed to the upper level. With this methodology, the designers can be sure that all the circuits have been considered at all levels and there would be no necessity for redesigning cycles. In [13], the BUO algorithm has been applied for two-level hierarchical design and in [14] this method is employed for splitting hierarchy to circuit design levels (i.e., system-circuit-device) as Fig. 5.a shows. Also, this method has been applied for optimizing an antenna array by starting with the single antenna [15]. As Fig. 5.b shows, the number of single antennas is increasing sequentially and the distance between single antennas is optimizing concurrently up to obtaining desired output performance.

Circuit-level: The BUO method has also been applied for optimizing circuit-level designs. The MNs are the essential parts of PAs that can be constituted using passive reactive components such as inductance (L), capacitor (C), and also lossless transmission lines (TLs) in both input and output MNs. The conventional method of designing PAs is tuning the harmonic impedances that can create difficulties for designers to handle high-dimensional data. To tackle this problem, the BUO methodology has been successfully applied recently for designing and optimizing a class-AB amplifier [16] where this algorithm is employed by getting benefit of two LC networks that are normalized to 50Ω on the Smith chart (see Fig. 6.a.). Figure 6.b presents the general structure of the optimized PA and the included MNs in the input and output MN sides. Designing the PA starts with two LC networks: one in the input MN and one LC in the output MN. Then on both sides, concurrently the number of LC units are increasing up to achieving desired output performance.

This BUO algorithm has been also recently employed for designing and optimizing a single microstrip antenna as Fig. 7 presents. This methodology is applied by sequentially increasing the number of TLs and altering the configuration of TLs [17]. The algorithm for designing a single microstrip antenna starts with one TL and

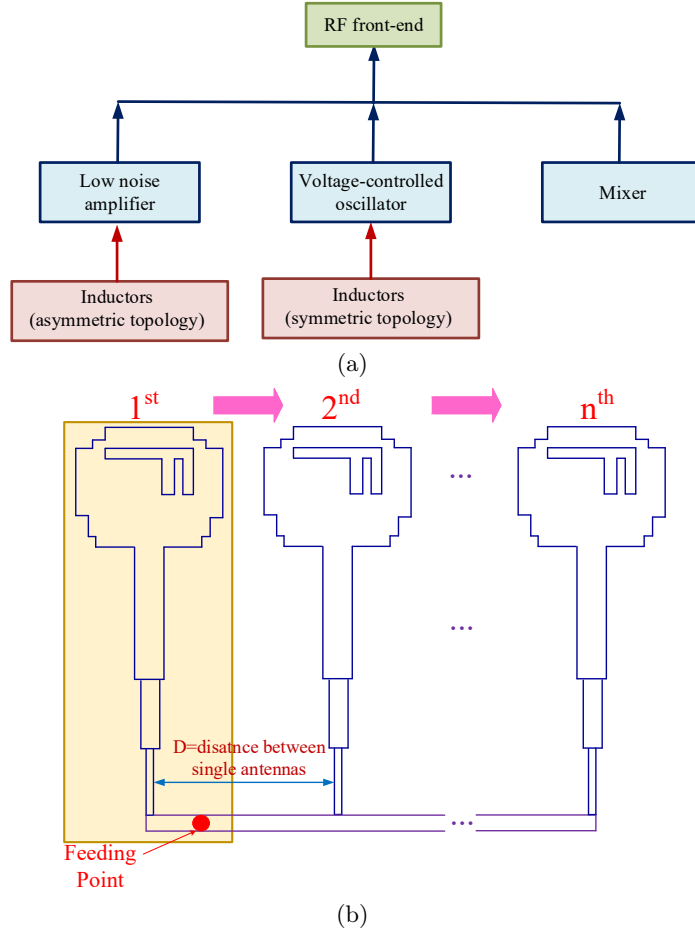

Fig. 5. System-level optimization using the BUO method; a) RF front-end system [LNA (low noise amplifier), VCO (voltage-controlled oscillator)] [14], b) antenna array design [15].

then the number of TLs are improved incrementally. It considers the generated output performances and it stops automatically when the required specifications as gain and bandwidth are obtained.

4.2 Top-Down Optimization (TDO)

Opposite to the BUO algorithm, the top-down optimization (TDO) method is the process of decomposing the system/circuit into sub-blocks. Figure 8 presents the general structure of two optimization methods (i.e., BUO and TDO methods) that are operating in con-

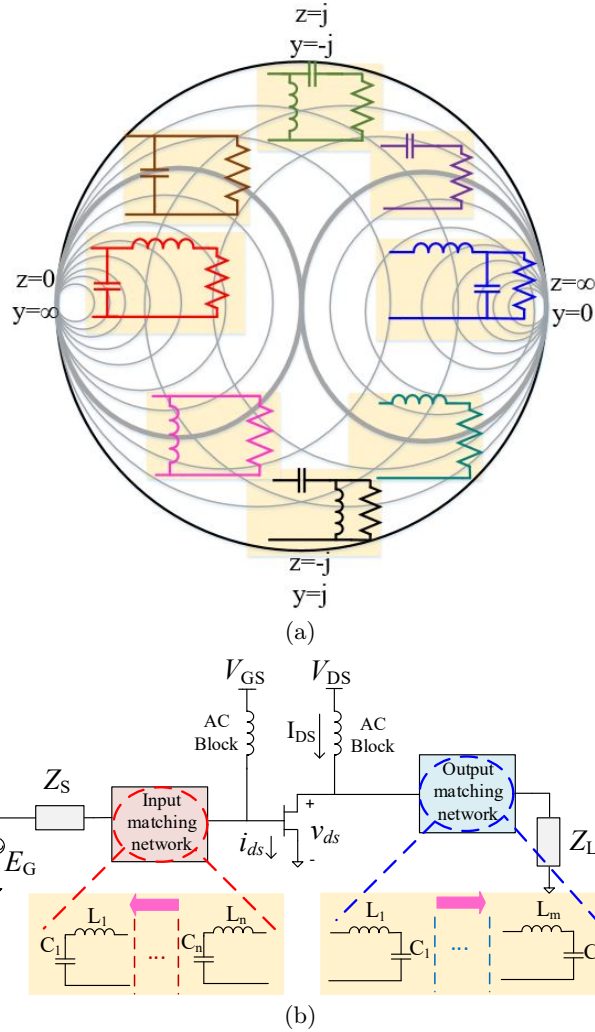

Fig. 6. BUO for optimizing PAs (circuit-level); a) various MN typologies in a normalized Smith chart, b) general PA structure includes MNs where the number of MNs are increasing sequentially [16].

trast. In the TDO method, the whole system is analyzed and formulated, then each sub-blocks is considered and optimized regarding the required specifications. This method starts with the complete whole design and breaks it down to small pieces.

In [18], this method has been applied for designing PAs with distributed elements. In this method, firstly a PA with lumped elements (LEs) using BUO is designed then the LE amplifier, is converted

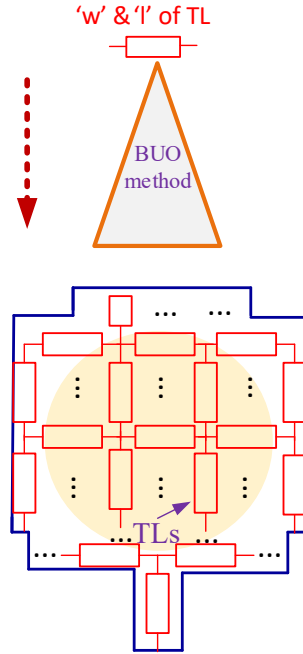

Fig. 7. The practical implementation of BUO method in designing a single antenna (circuit-level) [17].

to the PA with TLs by employing the TDO algorithm. The detail descriptions for employing this optimization has been presented in Algorithm 1. The TDO method leads to generate the post-layout structure by applying the fabrication rules and constraints.

Algorithm 1 Top-down optimization for designing and optimizing a PA

- 1:** Design a PA with lumped elements using BUO method;
 - 2:** Decompose the MNs into unit cells that include one inductance and one capacitor;
 - 3:** For each unit cell, examine and replace with with TLs;
 - 4:** Evaluate the performance of added TLs through the Gaussian process (GP);
 - 5:** From the various TL cell configurations, select the one that has maximum a posteriori (MAP).
-

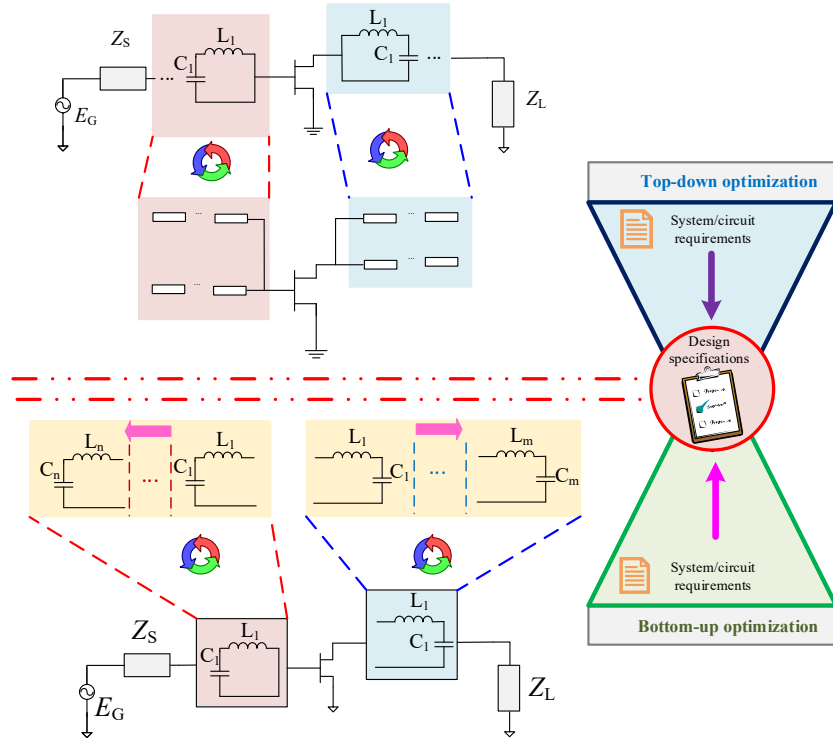

Fig. 8. General structure of top-down optimization versus bottom-up optimization in optimizing PAs [18].

4.3 Bayesian optimization (BO)

The Bayesian optimization (BO) is the method of optimizing single-objective or multi-objective functions that include continuous domains. The BO method is the common optimization method used in machine learning (ML). It is a black box optimization where for the defined input parameter (x) the output response ($f(x)$) is predicted with the BO method as Fig. 9 shows. This optimization constructs a surrogate for the objectives using Gaussian process (GP) regression. The BO method aims to solve the problem of ($max/min f(x)$) where the GP provides a Bayesian posterior probability distribution. When any f is created in a new point, the posterior distribution is updated as well. The acquisition function provides the new value with respect to the current posterior distribution. The general flowchart is shown in Fig. 10. This optimization method provides better convergence rates in comparison with the conventional methods used in the electronics design automation (EDA) tool [19].

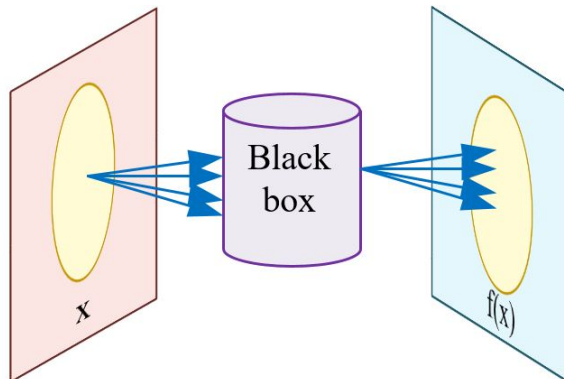

Fig. 9. Black box BO optimization.

In the BO method, firstly suitable training, validation, and testing data are created. Then GP model is built using the maximum a posteriori (MAP) metric as (10),

$$\omega_{MAP} = \underset{\omega}{\operatorname{argmax}} \prod_{i=1}^n \rho(y_i | f(x_i; \omega)) \rho(\omega) \quad (10)$$

where $\rho(\omega)$ is the prior probability with the weighting vector: $\omega = (\omega_1, \omega_2, \dots, \omega_m)$. x is the input data and y is the predicted output response.

After achieving the required MAP, the $x_t = \underset{x}{\operatorname{argmax}} [EI(x)PI(x)]$ is selected where acquisition functions are as following: EI is the expected improvement and PI is the probability of improvement. Please refer to [20] to the expanded formulations of these terms. Then the new output response is predicted using the Gaussian distribution as defined in (11-12) with a kernel function of $K(x, x')$, a mean $m(x)$, and a standard deviation $\sigma(x)$. The general GP model with training data (i.e., $D_0 = \{x_i, y_i\}$) is shown in Fig. 11. Finally, if the required specifications are not obtained then the GP model is updated.

$$m(x_{n+1}) = K^T [K + \sigma_n^2 I]^{-1} Y \quad (11)$$

$$\sigma^2(x_{n+1}) = K(x_{n+1}, x_{n+1}) - K^T [K + \sigma_n^2 I]^{-1} K \quad (12)$$

This method has been used in designing and optimizing various antennas [21,22,23,24]. In [21] based on the BO method, the uncertainty quantification (UQ) drawback in the antenna designs is

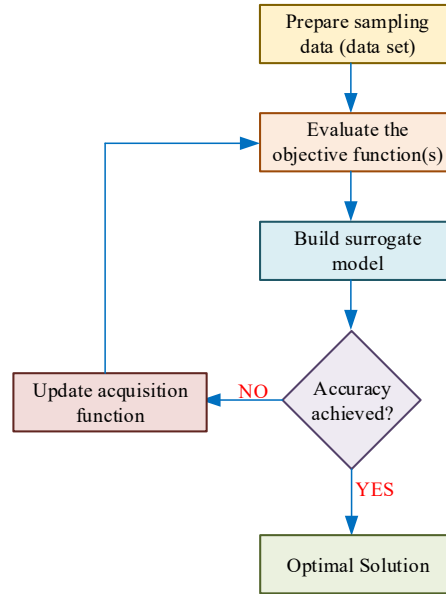

Fig. 10. General flowchart of the BO method.

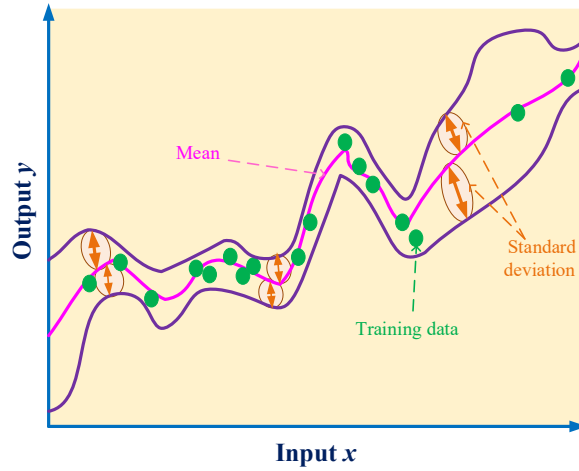

Fig. 11. The GP model for the given input data and the predicted output response.

solved that results in an accurate characterization of nonsmooth behaviours. As another application of this method in [25], by employing the BO method the design of simulation-driven antenna is accelerated. In the presented method, an updated version of EI acquisition function is described where the updated responses are considered using parallel computation. Like the previous BO based strategy

in [23], computational efficiency planar antenna design is described where an accurate antenna model is achieved using a reduced training sets.

Recently, sparse arrays in the near-field region have got the attention of researchers as they can be used in various industrial and biomedical applications. Hence for achieving high performance outcomes, larger apertures are required. This specification can be achieved when the number of elements are increasing; however this conventional method is costly. The study in [22] presents an optimization-oriented method with the aid of Bayesian compressive sensing and convex optimizations for solving the problem of near-field sparse array synthesis (see Fig. 12). As presented in Fig. 12, the reference pattern is sampled by the equations presented in (13) where the reference patterns are radiated by N candidate elements. The detailed parameter descriptions for (13) are as following: T is a truncation angle, K is the divided angle of solution space, and z provides the distance between the array aperture and the focal plane. Hence, the presented method in [22] provides the suitable truncation of the synthesis plane which lacks in the traditional methods.

$$\left\{ \begin{array}{l} x_k = z \times \tan\left(\frac{2T(k \bmod K_x)}{K_x - 1} - T\right) \\ y_k = z \times \tan\left(\frac{2T\lfloor \frac{k}{K_x} \rfloor}{K_y - 1} - T\right) \\ z_k = z \end{array} \right. \quad (13)$$

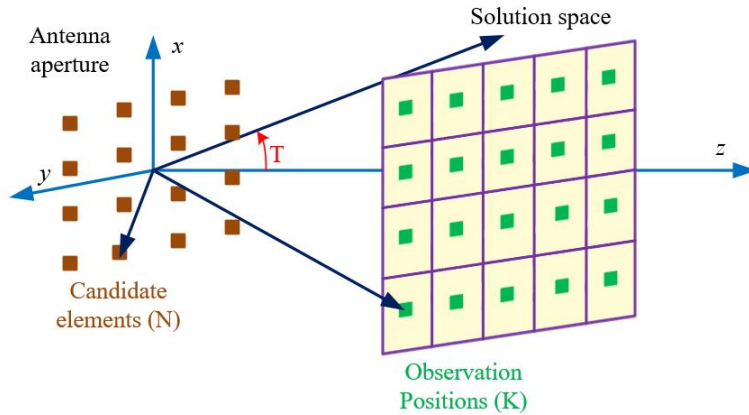

Fig. 12. Near-field focus problem [22].

Moreover, the number of antenna elements for designing the flat gain antenna array can be determined successfully by using the BO method [24] where the process is done automatically.

This useful optimization method can be used in designing high performance PAs as well and recently this method has shown its susceptibility and capability in various designs like one-stage PA and Doherty PA. Preparing post-layout scheme for any system design is not straightforward and requires additional efforts. Hence, an powerful optimization is required for providing the ready-to-fabricate layout which results in high performance PA characteristics. In [26], BO method is employed as an optimization tool for converting the PA with lumped elements to the PA with distributed elements which automatically optimizes the PA and generates the layout. The related optimization flowchart is shown in Fig. 13. The presented method in [26] is described in Algorithm 2, where all steps of the optimization is processing automatically.

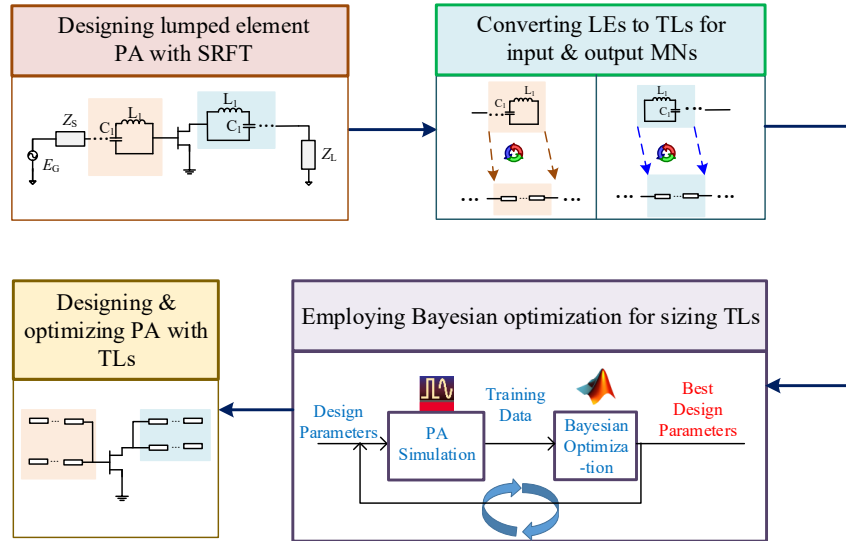

Fig. 13. Automated PA optimization with the BO method [26].

Algorithm 2 Converting lumped element PA to the PA with distributed elements based on the BO method

- 1:** Extract gate and drain impedances of used transistor;
- 2:** Import the achieved impedances to the simplified real frequency technique (SRFT) [27];
- 3:** Combine the obtained input MN and output MN from the SRFT and construct the PA;
- 4:** Convert each LE unit includes one capacitor and one inductance, to its TL model and provide sequential input and output MNs including TLs;
- 5:** Run BO method for predicting suitable design parameters of TLs (i.e., width and length of TLs). The objective functions are the real and imaginary responses of lumped element MNs;
- 6:** Apply presented method in [28] that automatically increases and decreases the component values (i.e., random optimization) as a final polishing stage.

In the following, other common optimizations that have recently been employed for designing printed antennas are reported that are divided into three sections namely as: *i*) optimizations based on animals, plants or insect behaviors, *ii*) optimizations based on human treatments, and *iii*) optimizations based on the evolution process.

4.4 Optimizations based on animals, plants or insect behaviours

This section provides an overview over the various intelligent methods that are used for optimizing antennas by using the behavior of animals, plants, or insects. Short descriptions of some of the most widespread methods and the considered applications are as follow:

Particle swarm optimization (PSO)

The PSO is based on the stochastic optimization technique and finds the optimal solution using the random iteration [29]. This optimization includes simple and quick algorithms and outperforms the design geometry and configuration with a slow convergence. This method has recently been employed for designing and optimizing in-homogeneous lens antenna, slot antenna, hemispherical antenna, band-gap resonator antenna, antenna array, and also for beam-forming network [30,31,32,33,34,35,36].

Ant colony optimization (ACO)

The ACO method is an effective method for determining the best path on a weighted graph by moving on the graph. In this method, among the various points, the ants are selecting the shortest path for moving to the determined destination as Fig. 14 shows. This method is based on the swarm intelligence techniques and it is effective in solving combinational optimization problems. It uses the behaviour of ants while searching for the food and storing the food in the nests.

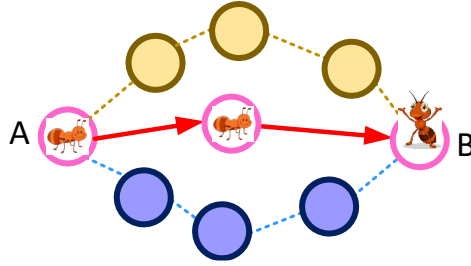

Fig. 14. Basic idea of ACO method in the graph; choosing the shortest path by ants.

In [37,38], the ACO method is employed for designing 3-D frequency selective structures (FSSs) and patch antenna arrays, respectively. In [37], the multi-objective lazy ant colony optimization (MOLACO) algorithm is applied for providing rapid and more accurate retrieval of S-parameters.

Artificial bee colony algorithm (ABC)

The ABC method is based on the swarm intelligence and is influenced by the behavior of honey bees [39]. The bees in the colony continuously fly until achieving the best solution in the multidimensional solution space. Recently, this method has been employed for solving electromagnetic problems, optimizing antenna size, gain, and also conjugate matching [40]. For illustrating an application of the ABC method, Fig. 15 presents the outcome of a practical implementation of this algorithm in designing spiral shaped antenna before and after the optimization.

Artificial plant optimization algorithm (APOA)

Plants have a nervous system that becomes suitable for solving large combinatorial problems. This method is inspired from the

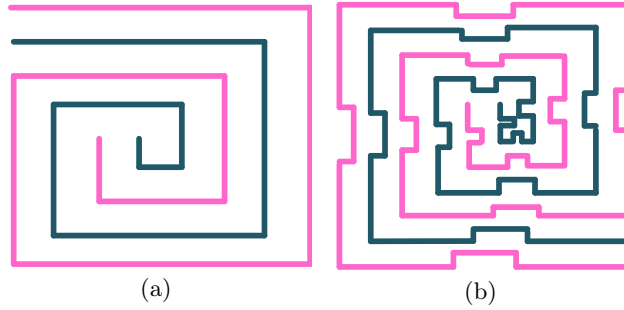

Fig. 15. Optimizing spiral antenna using ABC method [41]; a) before optimization, b) after optimization.

growth behaviour of plants and includes the photosynthesis and phototropism mechanism [42].

For designing a printed Yagi antenna, in [43] invasive weed optimization (IWO) is employed that is a population-based evolutionary optimization algorithm inspired by the behaviour of weed colonies. This method is a close-loop optimization and it is suitable for shape and structure optimization. In another study ([44]), IWO method is employed for optimizing the spacing between the elements leading to provide suitable radiation patterns.

Chicken swarm optimization (CSO)

The CSO method is a bioinspired algorithm that patterns the hierarchical order in the chicken swarm by considering the chicken's swarm behaviour [45].

This method has an easy implementation and it has a satisfied performance in reducing the sidelobe of antennas [46,47,48,49]. As a practical application, Fig. 16 presents the implementation of this algorithm for three types of antennas in order to provide the better beam pattern optimized outcomes [47]. In this method, suppressing the maximum sidelobe level for linear antenna array, circular antenna array, and random antenna array is investigated.

Bacterial foraging optimization (BFO)

The BFO algorithm is inspired from the social foraging behaviour of escherichia coli bacteria, and mimics the bacteria forage over a landscape of nutrients [50,51]. This method has been successfully

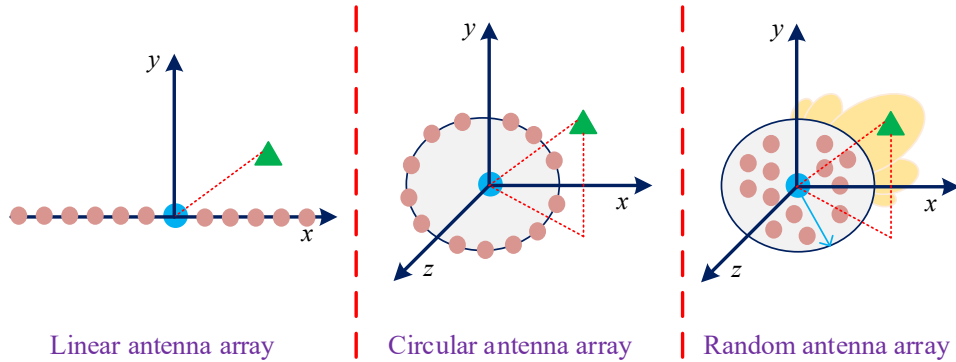

Fig. 16. Employed CSO method in [47] for optimizing different antenna arrays.

applied in various problems and it shows effectiveness in many microwave designs. In [52], this algorithm is applied for MIMO system designs and it tackles the problem of a combinatorial non-convex optimization.

Other optimization methods

There are some other optimization methods as: firefly algorithm (FA) [53,54], fruit fly optimization algorithm (FOA) [55,56], grey wolf optimizer (GWO) [57], shuffled frog leaping algorithm (SFLA) [58], cuckoo search algorithm (CSA) [59,60], biogeography based optimization (BBO) [61], and bat algorithm (BA) [62]. These algorithms are recently applied for designing and optimizing antennas and demonstrate their validity by providing satisfactory output performances [63].

4.5 Optimizations based on human treatments

In this section, we will provide various optimization methods that are inspired from the behaviour and treatment of humans. Some subsets of this kind of optimizations are namely as: harmony search (HS) algorithm, teaching learning based optimization (TLBO), and also social emotional optimization algorithm (SEOA).

Harmony search (HS) algorithm

This optimization is based on the musical harmony and creates music with the combination of sounds generated from various music instruments.

This optimization is employed in various applications like: reducing side-lobe and side-band in timed antenna array [64], determining the optimal element positions in the annular sectors [65], and also optimizing the linear aperiodic arrays with a minimum peak side-lobe level [66].

Teaching learning based optimization (TLBO) and Social emotional optimization algorithm (SEOA)

The basic definition of teaching learning based optimization (TLBO) method is the influence of a teacher on learners [67]. In [68] and [69], this method is employed for reducing power consumption in MIMO systems and for determining the slot shape with diode location in the ground plane of antennas, respectively.

The social emotional optimization algorithm (SEOA) is an intelligent algorithm that simulates the human social behaviours. In this method, each point presents one person and the total points build the social status of society. In [70], this method is employed for considering the antenna selection and power allocation design in the massive MIMO networks. This method becomes effective in promoting energy conservation and in provision of satisfied quality of service (QoS) in the whole 5G networks.

4.6 Optimizations based on the evolution algorithm (EA)

The evolutionary algorithm (EA) is one of the branch of evolutionary computation and uses the mechanisms inspired by biological evolution. This method is generally applied for optimizing antennas and are divided into four subsections as genetic algorithm (GA), differential evolution (DE) algorithm, memetic algorithm (MA), and artificial intelligence (AI).

Genetic algorithm (GA)

The genetic algorithm (GA) is the random-based evolutionary algorithm that randomly changes the current points up to achieving the suitable output performance. Figure 17 presents the overview process of the GA method that is based on the chromosome of the population. This method consists of phases as: initialization of population, fitness function, selection, reproduction, and convergence.

The initialization of population is the coding part that is the collection of parameters and variables. By determining the fitness values, fitness function calculates how good the solution is. Selection is responsible for determining the region where optimal solution can be found. Reproduction provides the evolution process up to finding optimal response. Finally, convergence includes some rules that inform when the optimization process can stop.

The GA method is popular among the RF designers and they have employed this method in various antenna designs. In [71], this method is employed in the design of antenna array for minimizing the peak side lobe level. Also, this method is applied for optimizing sparse array in [72,73].

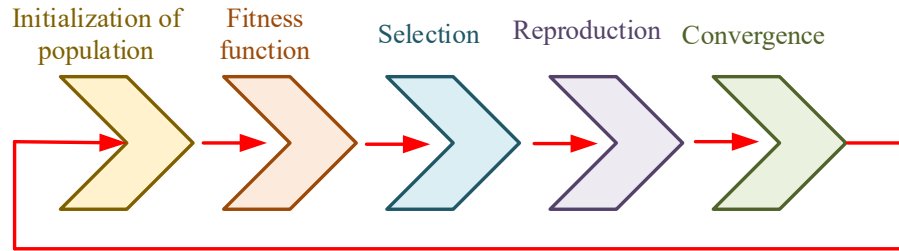

Fig. 17. The general process of GA method.

Differential evolution (DE)

The differential evolution (DE) method can solve the optimization problem by iteratively improving a candidate solution; it belongs to the stochastic population-based evolutionary method. This algorithm is able to explore the large design spaces in a short time with few assumptions and would solve a wide range of optimization problems in an approximate way. For the continuous optimization problems, this algorithm is beneficial and recently it is used in both scientists and engineering professionals.

This method like GA method has been applied for various modifications that are aim to improve the performance of various antennas and systems [74,75].

Memetic algorithm (MA)

The Memetic algorithm (MA) is the extension of the GA method and it gets benefit of the local search technique for reducing the likelihood. This method is a hybrid optimization that is combining a global search evolutionary algorithm with a local search method. The global search can provide good initial solutions, and the local search algorithm helps the optimization to find the specific region with fewer evaluations [76]. As a practical utilization, in [77] this method is employed for designing and optimizing microstrip array antenna that is constructed by a planar layout of elements, coaxial feeders, and circular feed points.

Intelligent techniques include artificial intelligent (AI), machine learning (ML), neural network (NN), and deep learning (DL)

As Fig. 18 shows, the artificial intelligence (AI) includes machine learning (ML), neural network (NN), and also deep learning (DL). The AI is a program that can sense, reason, act, and adapt. In other words, AI is the technique of enabling machines to mimic human intelligence.

The ML includes typical algorithms such as BO method (detailed description of BO method is described in Sec. (4.3)). This type of method learns from the data and incorporates math and statistics for predicting the output responses of entered input data. The implemented algorithms require data to be trained in order to model any circuit/design and make prediction for any future data with minimum difference from the actual values. The more data, the best estimation and modeling can be achieved. What makes the ML interesting in the electronic designs, is providing an automated environment. Shortly, ML models are optimization algorithms and in case, the design is modelled correctly with this learning type, the error-function (i.e., loss-function) is reduced. As shown in Fig. 19, ML is divided into various subsections namely as: supervised learning, unsupervised learning, and reinforcement learning. In supervised learning, ML optimizes the weights of the cost function and maps the relationships between input and output data. In reverse, unsupervised learning is not supporting and is not giving the labels of the dataset at the output. Thus, this type of learning is underlying the hidden patterns in the input, and it is clustering the included elements of the input dataset. Additionally, reinforcement learning,

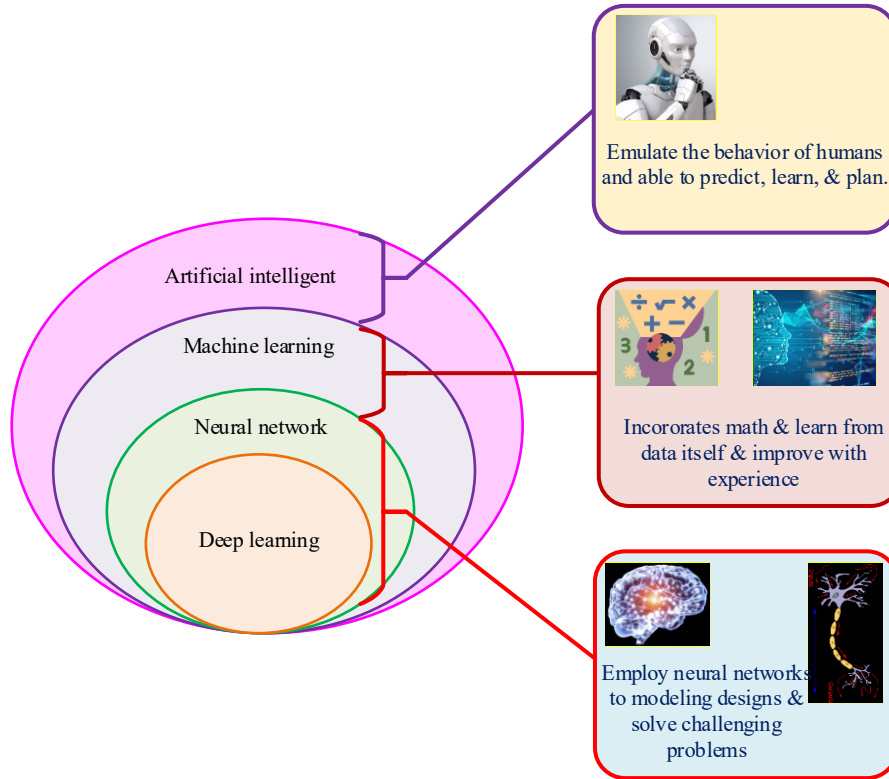

Fig. 18. Various techniques to mimic the human intelligence.

like supervised learning, can create the relation between input and output data but it includes reward function while this mechanism does not exist in supervised and unsupervised leanings.

Shallow neural network (SNN) and deep neural network (DNN) are networks where neurons are connected to each other and each neuron includes a weighted sum of the inputs and one activation function.

Generally, the activation function can be sigmoid function, rectified linear unit (RELU), threshold, or softmax. Also, depending on the type of applied NN, the loss function can be varied. The main employed algorithms for NNs can be feed-forward propagation or backward-propagation where the first algorithm determines the output as a function of inputs and the second algorithm calculates the weights to minimize the error between the predicted output response and the actual value.

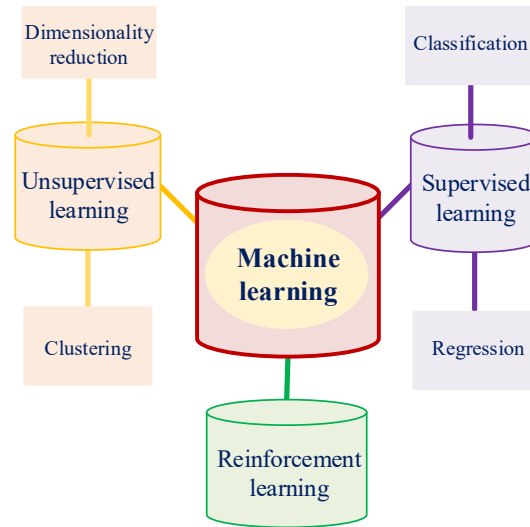

Fig. 19. Subsections of the ML.

As another subset of AI, DL is recently developed in engineering fields where it is based of the artificial NNs. It can predict the unknown output responses for the determined input data by using the feed-forward and back-propagation algorithms.

DNNs include a multi-layered structure in opposite of SNNs where one hidden layer exists. As Fig. 20 depicts, the clear advantages of DL over the ML is needlessness of the so-called '*Feature Extraction*'. In DNNs, the feature extraction is employed in the hidden layers and training process is performed and completed without manual effort. The feature extraction is somehow complex process that needs the information of the problem domain. This step requires several iterations in order to achieve optimal output response. Therefore, in DNNs, the hidden layers by themselves can learn an implicit representation from the data set. For training any DNN, large amount of data is required; hence, by increasing the number of data, the NNs are trained and constructed more accurately. Therefore, the performance of DNN is more accurate that the SNNs.

In summary, there are two main differences between ML and DL, that are: *i*) In ML all the data requirements are labeled and the features are known; however, in DL the data is unlabeled and DL is trained intelligent in predicting the imported data, *ii*) the domain

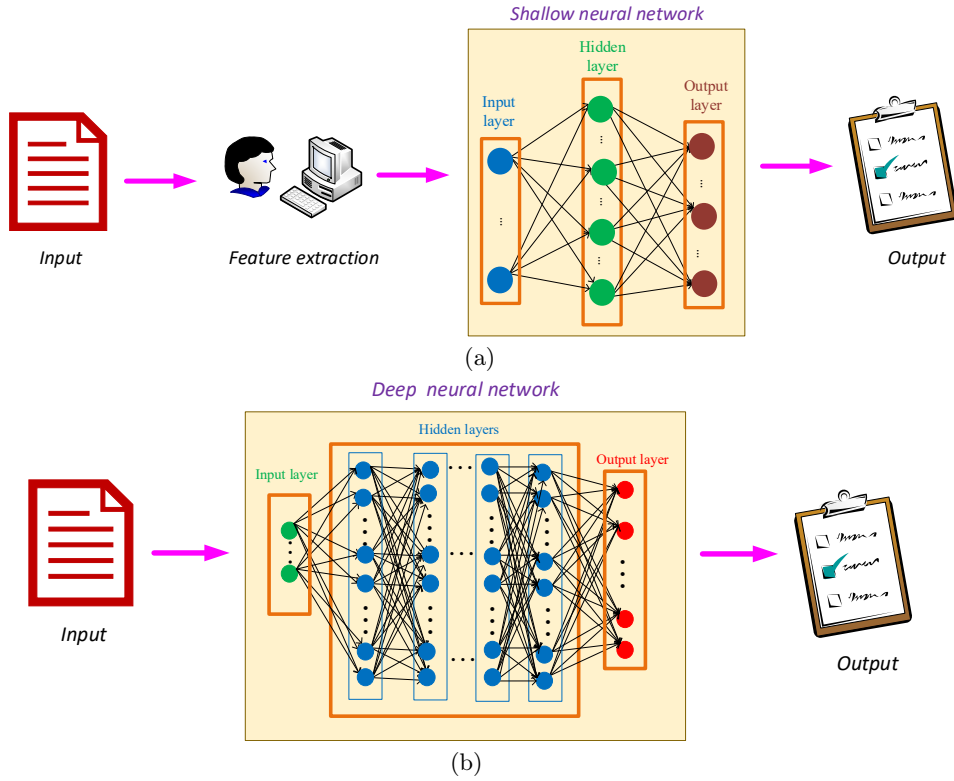

Fig. 20. a) Machine learning includes SNN, and b) Deep learning involves DNN.

used of DL is large and it can be suitable for other applications such as image, video, and audio.

Application of AI, ML, NN, and DL in PA designs and optimizations

For creating AI, there are various approaches as: artificial neural network (ANN), recurrent neural network (RNN), convolutional neural network (CNN), DNN, and deep belief network (DBN) [78]. As described in Sec. 4.6, AI learns from the perceived environment and gets benefit of large amount of datasets generated from communication and wireless systems. This filed of knowledge is beneficial in solving complex problems of wireless communication systems and RF designs like network management, decision making, and resource optimization. The use of this science in power amplifiers are described as follow:

The PAs are the circuits which include high dimensional variables and due to the nonlinear behavior of used transistors, providing the optimization goals is not straightforward. Hence, recently ANNs have got the attention of researchers for finding satisfactory solutions in the microwave circuit optimizations. In this section, some of the recently optimized PAs using SNN and DNN are described in detail.

In [79], a two-step automated methodology for designing and optimizing a PA using the SNN is presented. In the first step of optimization, the SNN is modeled for the designed PA with lumped elements. Then in the second phase, the PA includes Tls is optimized using the trained SNN model of the first step. Figure 21 presents the overall flowchart which leads to generate a PA's layout.

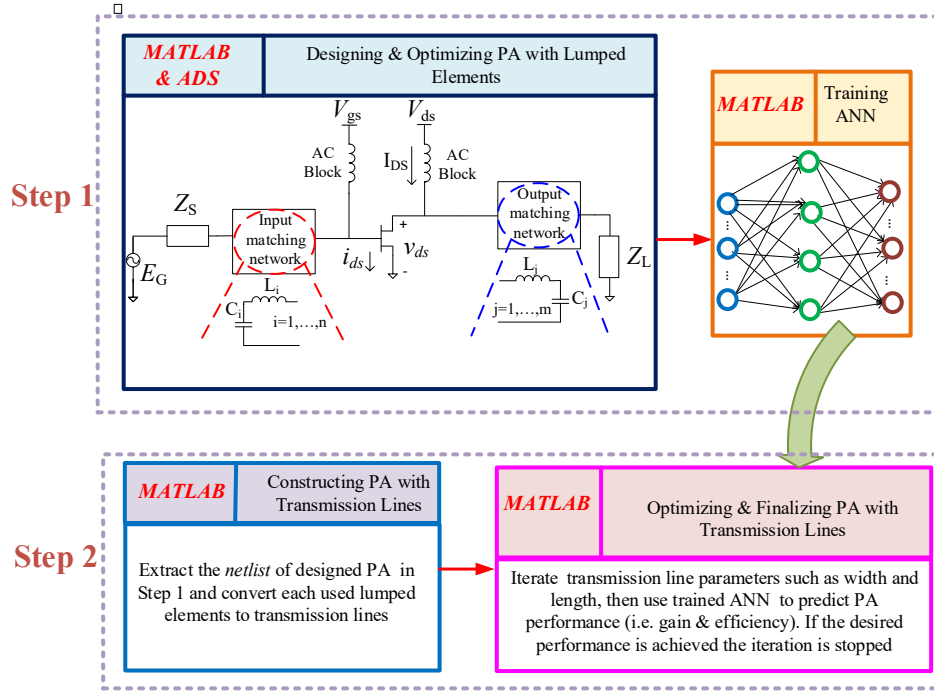

Fig. 21. Automatically converting the PA with LEs to the PA with Tls using the SNN [79].

In [4] based on the supervised learning, one classification DNN and one regression DNN are used sequentially for optimizing high performance PA designs. Algorithm 3 explains in detail the employed

steps for the black-box optimization where the transistor model is selected; a suitable PA layout for fabrication can be achieved (see Fig. 22). Please refer to [4] for getting detailed information about the employed optimization method.

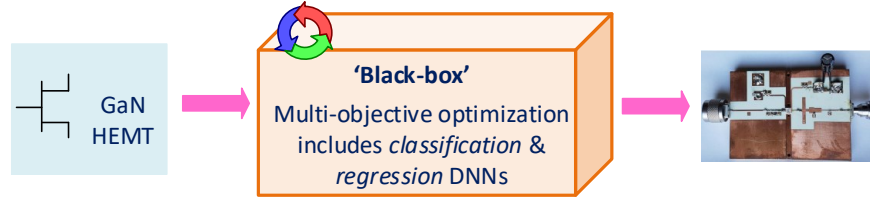

Fig. 22. Automated design of PA using advanced black-box optimization [4].

Algorithm 3 Automated high performance PA optimization using DNNs

- 1:** Extract transistor's characteristics in terms of P_L , G_p , and η_D that have been presented in the data sheet of transistor as well;
 - 2:** Employ classification DNN for predicting the best PA structure with LEs among various obtained PAs from the SRFT method;
 - 3:** Apply S-parameter simulation for converting LE power amplifier to the PA with TLs;
 - 4:** Implement multi-objective optimization for optimizing P_L , G_p , and η_D specifications;
 - 5:** Employ regression DNN for optimizing TLs' parameters and predicting the best values of included components and finally generating the layout with the design parameters.
-

Application of AI, ML, NN, and DL in antenna designs and optimizations

Recently, researchers get benefit of AI techniques and EA in designing various circuits. These methods have got the attention of designers due to the large advances in communication technologies that in turn requires the ability to deal with large amount of data. AI-enabled methodologies as ML and DL have been used variously in 5G wireless communications, massive MIMO, beam-forming, and various antennas designs.

Generally, MIMO systems are used for improving the communication performance in both sender and receiver sides by installing multiple antennas (see Fig. 23.a). Therefore, the complexity in the MIMO systems is huge and multi-objective optimizations based on AI are needed to provide an accurate channel estimation with optimized weights of antenna elements. Figure 23.b presents the structure of MIMO systems include pilots where the system has a base station (BS) with many antennas that serve user terminals [80].

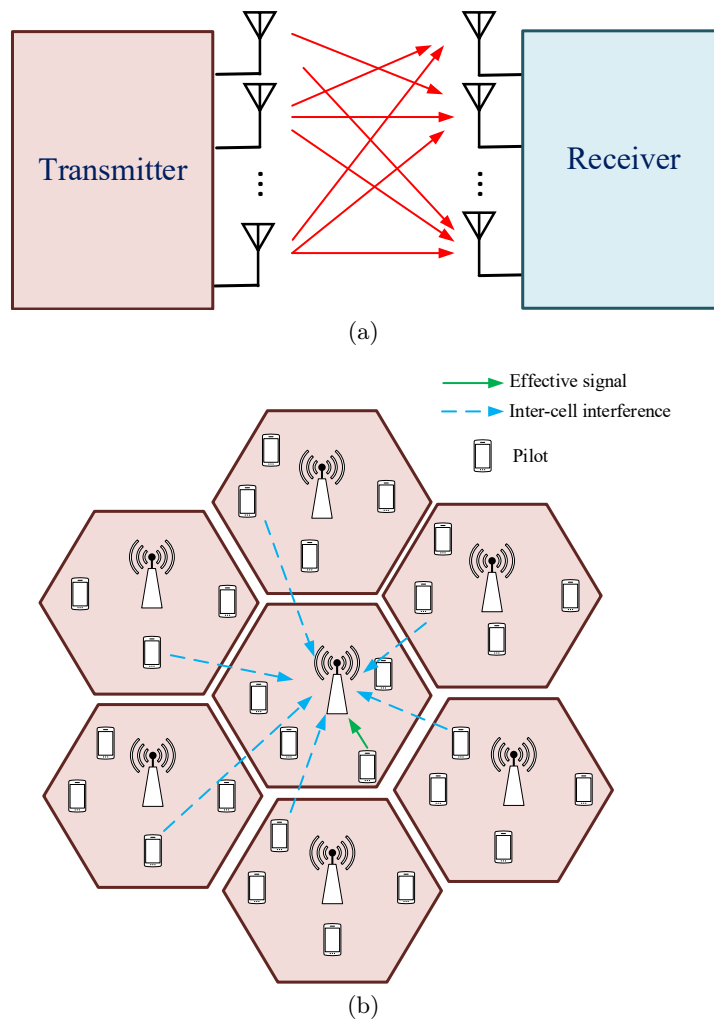

Fig. 23. a) The general structure of MIMO system includes transmitter and receiver; b) massive MIMO system model includes pilots [80].

As the communication technology is improving, transmission and reception of signal power may face with high problems. One of the feature of 5G wireless networks is the massive MIMO that paves the way of future 6G networks. Transferring from MIMO to massive MIMO requires many service antennas that are fully connected to each other. These antennas are placed over the active terminals, and in both sides of receiver and transmitter. Massive MIMOs are typically based on time division duplex (TDD); however, the frequency division duplex (FDD) provides more interest of researchers due to its improved coverage and minimized interference. In the FDD mode, the downlink and uplink channels are divided in frequency. Figure 24 shows the downlink training process with the pilot transmission [81].

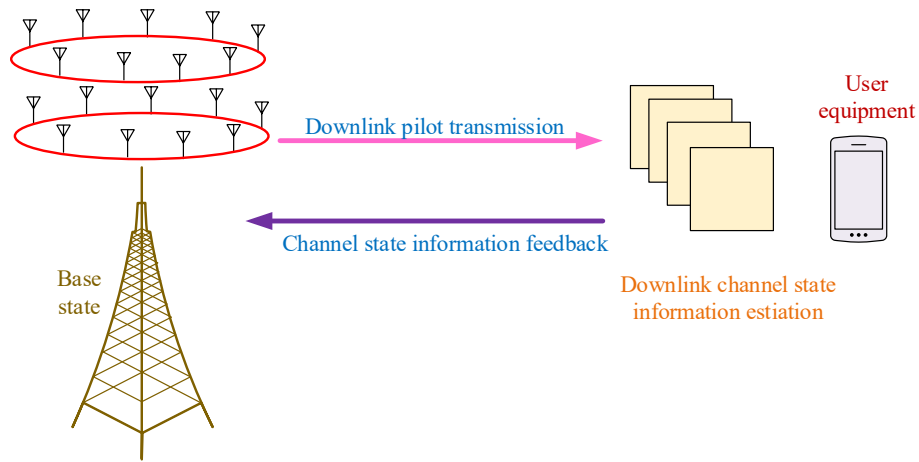

Fig. 24. Downlink training process in the massive MIMO systems [81].

Recently, designers employ AI methods for solving the symbol detection problems for mapping channels in the space [82] and also providing satisfactory power allocation in massive MIMO systems [83]. For improving the performance of massive MIMOs, DL methods can be employed for the pilot contamination drawbacks. Figure 25 presents the use of DNN for reducing the pilot contamination by learning the relationship between the input feature and output labels [84].

The DNNs would be used to model the correlation between pilot assignment and the users' location pattern. For the depicted DNN in Fig. 25, the input feature can be location, channel quality, and inter-cell interference of users. The employed algorithms in DNN can be deep multilayer perceptron (MLP), convolutional neural network (CNN), recurrent neural network (RNN), and long short-term memory (LSTM). The corresponding output features would be the labels determine pilot assignment and users with pilot selections.

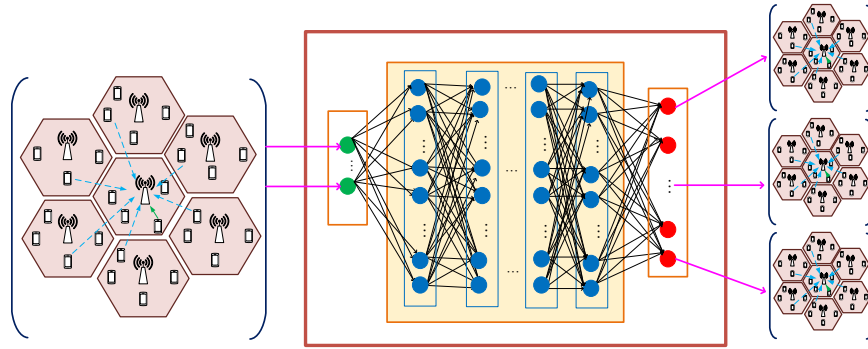

Fig. 25. The application of DNN for the pilot assignment [84].

In summary, the application of AI methods for the massive MIMO are as following:

- Pre-processing in wireless communication;
- Modulation recognition;
- Beam selection;
- Channel estimation;
- Antenna selection.

5 Conclusion

The next-generation networks (5G, 6G) will provide strong breakthrough advancement with respect to the previous technologies and it is expected they will support various new services based on advanced communication technologies such high data rate can offer. In the design of high performance circuits and systems, finding coherent solutions for the determined problems is critical and optimal solutions are mainly sought by modifiable and perceptive algorithms. Global optimizations are required to optimize expensive

objective functions and to accommodate the requirements of communication systems. Accordingly, highly accurate transfer functions between input and output ports must be modeled to optimize communication parameters. Advanced optimization methods can construct the transfer functions adaptively and accommodate diverse requirements, such as power consumption, latency, energy, secure two-way communications, speed, and connectivity.

The power amplifiers are the very significant devices in the communications systems where output power of the PAs can influence on the quality of transmitted signal. Therefore, advanced optimization methods are required for achieving optimal performances that are challenging between various specifications such as efficiency, linearity, gain, and output power. Additionally, installing high performance antennas in the communication systems plays an important role. For this case we overview recently reported flexible optimization methods that are employed in optimizing power amplifiers and antennas, lead to achieve high performance output results.

Herein, relevant questions over various optimization methods are stipulated such as: what are the conceptual and structural viewpoints of reported optimization methods? Can the methods offer industrially acceptable solutions? What are the potential applications of each method? These queries are addressed by conducting a detailed and precise literature survey on diverse optimization methods employed in power amplifiers and also antenna designs. A detailed theoretical description for many methods is prepared to elucidate future research directions for optimizing specific characteristics with multi-objective optimizations. This leads to monolithic connection and processes a reliable connection through the mobility of UEs within the cells.

References

1. M. Ikram, N. Nguyen-Trong, and A. M. Abbosh, "Common-aperture sub-6 ghz and millimeter-wave 5g antenna system," *IEEE Access*, vol. 8, pp. 199 415–199 423, 2020.
2. "ITU-T: Setting the standard," <https://www.itu.int/en/mediacentre/backgrounders/Pages/itu-t-setting-the-standard.aspx>, accessed: 2020-12-12.
3. P. Chen, J. Xia, B. M. Merrick, and T. J. Brazil, "Multiobjective bayesian optimization for active load modulation in a broadband 20-w gan doherty power amplifier design," *IEEE Transactions on Microwave Theory and Techniques*, vol. 65, no. 3, pp. 860–871, 2017.
4. L. Kouhalvandi, O. Ceylan, and S. Ozoguz, "Automated deep neural learning-based optimization for high performance high power amplifier designs," *IEEE Transac-*

- tions on Circuits and Systems I: Regular Papers, vol. 67, no. 12, pp. 4420–4433, 2020.
5. B. Kim, “Chapter 2 - power amplifier fundamentals,” in *RF and mm-Wave Power Generation in Silicon*, H. Wang and K. Sengupta, Eds. Oxford: Academic Press, 2016, pp. 17–58. [Online]. Available: <https://www.sciencedirect.com/science/article/pii/B9780124080522000025>
 6. P. M. Lavrador, T. R. Cunha, P. M. Cabral, and J. Pedro, “The linearity-efficiency compromise,” *IEEE Microwave Magazine*, vol. 11, no. 5, pp. 44–58, 2010.
 7. G. Luong, E. Kerhervé, J. Pham, and P. Medrel, “A 2.5-ghz multimode broadband bias-segmented power amplifier with linearity-efficiency tradeoff,” *IEEE Microwave and Wireless Components Letters*, vol. 28, no. 11, pp. 1038–1040, 2018.
 8. L. C. Nunes, P. M. Cabral, and J. C. Pedro, “Am/am and am/pm distortion generation mechanisms in silicon ldmos and gan hemt based rf power amplifiers,” *IEEE Transactions on Microwave Theory and Techniques*, vol. 62, no. 4, pp. 799–809, 2014.
 9. L. Piazzon, R. Giofrè, R. Quaglia, V. Camarchia, M. Pirola, P. Colantonio, F. Giannini, and G. Ghione, “Effect of load modulation on phase distortion in dohertry power amplifiers,” *IEEE Microwave and Wireless Components Letters*, vol. 24, no. 7, pp. 505–507, 2014.
 10. G. L. Goh, J. Ma, K. L. F. Chua, A. Shweta, W. Y. Yeong, and Y. P. Zhang, “Inkjet-printed patch antenna emitter for wireless communication application,” *Virtual and Physical Prototyping*, vol. 11, no. 4, pp. 289–294, 2016. [Online]. Available: <https://doi.org/10.1080/17452759.2016.1229802>
 11. H. Saghlatoon, L. Sydänheimo, L. Ukkonen, and M. Tentzeris, “Optimization of inkjet printing of patch antennas on low-cost fibrous substrates,” *IEEE Antennas and Wireless Propagation Letters*, vol. 13, pp. 915–918, 2014.
 12. V. Pynttari, E. Halonen, H. Sillanpää, M. Mantysalo, and R. Mäkinen, “Rf design for inkjet technology: Antenna geometries and layer thickness optimization,” *IEEE Antennas and Wireless Propagation Letters*, vol. 11, pp. 188–191, 2012.
 13. T. Eeckelaert, R. Schoofs, G. Gielen, M. Steyaert, and W. Sansen, “An efficient methodology for hierarchical synthesis of mixed-signal systems with fully integrated building block topology selection,” in *2007 Design, Automation Test in Europe Conference Exhibition*, 2007, pp. 1–6.
 14. F. Passos, E. Roca, J. Sieiro, R. Fiorelli, R. Castro-López, J. M. López-Villegas, and F. V. Fernández, “A multilevel bottom-up optimization methodology for the automated synthesis of rf systems,” *IEEE Transactions on Computer-Aided Design of Integrated Circuits and Systems*, vol. 39, no. 3, pp. 560–571, 2020.
 15. F. Mir, L. Matekovits, L. Kouhalvandi, and E. O. Gunes, “Optimization for wide-band linear array antenna through bottom-up method,” in *2020 IEEE International Conference on Electrical Engineering and Photonics (EExPolytech)*, 2020, pp. 51–54.
 16. L. Kouhalvandi, O. Ceylan, and S. Ozoguz, “Automated matching network modeling and optimization for power amplifier designs,” in *2019 11th International Conference on Electrical and Electronics Engineering (ELECO)*, 2019, pp. 510–513.
 17. F. Mir, L. Kouhalvandi, L. Matekovits, and E. O. Gunes, “Electromagnetic bottom-up optimization for automated antenna designs,” in *2020 IEEE Asia-Pacific Microwave Conference (APMC)*, 2020, pp. 792–794.
 18. L. Kouhalvandi, O. Ceylan, and S. Ozoguz, “Automated top-down pruning optimization approach in rf power amplifier designs,” *Analog Integrated Circuits*

- and *Signal Processing*, Oct 2020. [Online]. Available: <https://doi.org/10.1007/s10470-020-01730-w>
19. S. J. Park, B. Bae, J. Kim, and M. Swaminathan, "Application of machine learning for optimization of 3-d integrated circuits and systems," *IEEE Transactions on Very Large Scale Integration (VLSI) Systems*, vol. 25, no. 6, pp. 1856–1865, 2017.
 20. A. I. Forrester and A. J. Keane, "Recent advances in surrogate-based optimization," *Progress in Aerospace Sciences*, vol. 45, no. 1, pp. 50 – 79, 2009. [Online]. Available: <http://www.sciencedirect.com/science/article/pii/S0376042108000766>
 21. D. Kan, D. Spina, S. De Ridder, F. Grassi, H. Rogier, and D. V. Ginste, "A machine-learning-based epistemic modeling framework for textile antenna design," *IEEE Antennas and Wireless Propagation Letters*, vol. 18, no. 11, pp. 2292–2296, 2019.
 22. Z. X. Huang and Y. J. Cheng, "Near-field pattern synthesis for sparse focusing antenna arrays based on bayesian compressive sensing and convex optimization," *IEEE Transactions on Antennas and Propagation*, vol. 66, no. 10, pp. 5249–5257, 2018.
 23. J. P. Jacobs, S. Koziel, and S. Ogurtsov, "Computationally efficient multi-fidelity bayesian support vector regression modeling of planar antenna input characteristics," *IEEE Transactions on Antennas and Propagation*, vol. 61, no. 2, pp. 980–984, 2013.
 24. C. Chan and P. M. Goggans, "Using bayesian inference for linear antenna array design," *IEEE Transactions on Antennas and Propagation*, vol. 59, no. 9, pp. 3211–3217, 2011.
 25. J. Zhou, Z. Yang, Y. Si, L. Kang, H. Li, M. Wang, and Z. Zhang, "A trust-region parallel bayesian optimization method for simulation-driven antenna design," *IEEE Transactions on Antennas and Propagation*, pp. 1–1, 2020.
 26. L. Kouhalvandi, O. Ceylan, and S. Ozoguz, "Automated rf power amplifier optimization and design: From lumped elements to distributed elements," in *2019 27th Telecommunications Forum (TELFOR)*, 2019, pp. 1–4.
 27. S. Yarman, "Design of ultra wideband power transfer networks," *New York, NY, USA: Wiley*, 2010.
 28. L. Kouhalvandi, O. Ceylan, and H. B. Yagci, "Power amplifier design optimization with simultaneous cooperation of eda tool and numeric analyzer," in *2018 18th Mediterranean Microwave Symposium (MMS)*, 2018, pp. 202–205.
 29. D. Wang, D. Tan, and L. Liu, "Particle swarm optimization algorithm: an overview," *Soft Computing*, vol. 22, no. 2, pp. 387–408, Jan 2018. [Online]. Available: <https://doi.org/10.1007/s00500-016-2474-6>
 30. J. Budhu and Y. Rahmat-Samii, "A novel and systematic approach to inhomogeneous dielectric lens design based on curved ray geometrical optics and particle swarm optimization," *IEEE Transactions on Antennas and Propagation*, vol. 67, no. 6, pp. 3657–3669, 2019.
 31. C. Jarufe, R. Rodriguez, V. Tapia, P. Astudillo, D. Monasterio, R. Molina, F. P. Mena, N. Reyes, and L. Bronfman, "Optimized corrugated tapered slot antenna for mm-wave applications," *IEEE Transactions on Antennas and Propagation*, vol. 66, no. 3, pp. 1227–1235, 2018.
 32. M. Tang, X. Chen, M. Li, and R. W. Ziolkowski, "Particle swarm optimized, 3-d-printed, wideband, compact hemispherical antenna," *IEEE Antennas and Wireless Propagation Letters*, vol. 17, no. 11, pp. 2031–2035, 2018.
 33. A. Lalbakhsh, M. U. Afzal, and K. P. Esselle, "Multiobjective particle swarm optimization to design a time-delay equalizer metasurface for an electromagnetic band-gap resonator antenna," *IEEE Antennas and Wireless Propagation Letters*, vol. 16, pp. 912–915, 2017.

34. V. D. Pegorara Souto, R. D. Souza, B. F. Uchôa-Filho, A. Li, and Y. Li, "Beam-forming optimization for intelligent reflecting surfaces without csi," *IEEE Wireless Communications Letters*, vol. 9, no. 9, pp. 1476–1480, 2020.
35. L. Song, W. Gao, C. O. Chui, and Y. Rahmat-Samii, "Wideband frequency re-configurable patch antenna with switchable slots based on liquid metal and 3-d printed microfluidics," *IEEE Transactions on Antennas and Propagation*, vol. 67, no. 5, pp. 2886–2895, 2019.
36. Z. Qu, S. Qu, Z. Zhang, S. Yang, and C. H. Chan, "Wide-angle scanning lens fed by small-scale antenna array for 5g in millimeter-wave band," *IEEE Transactions on Antennas and Propagation*, vol. 68, no. 5, pp. 3635–3643, 2020.
37. D. Z. Zhu, M. D. Gregory, P. L. Werner, and D. H. Werner, "Fabrication and characterization of multiband polarization independent 3-d-printed frequency selective structures with ultrawide fields of view," *IEEE Transactions on Antennas and Propagation*, vol. 66, no. 11, pp. 6096–6105, 2018.
38. E. Rajo-Iglesias, Quevedo-Teruel, and L. Inclan-Sanchez, "Mutual coupling reduction in patch antenna arrays by using a planar ebg structure and a multilayer dielectric substrate," *IEEE Transactions on Antennas and Propagation*, vol. 56, no. 6, pp. 1648–1655, 2008.
39. K. Diwold, M. Beekman, and M. Middendorf, *Honeybee Optimisation – An Overview and a New Bee Inspired Optimisation Scheme*. Berlin, Heidelberg: Springer Berlin Heidelberg, 2011, pp. 295–327. [Online]. Available: https://doi.org/10.1007/978-3-642-17390-5_13
40. S. K. Goudos, K. Siakavara, and J. N. Sahalos, "Novel spiral antenna design using artificial bee colony optimization for uhf rfid applications," *IEEE Antennas and Wireless Propagation Letters*, vol. 13, pp. 528–531, 2014.
41. —, "Novel spiral antennas design using swarm intelligence for passive uhf rfid tags," in *2013 7th European Conference on Antennas and Propagation (EuCAP)*, 2013, pp. 3223–3227.
42. S. Akyol and B. Alatas, "Plant intelligence based metaheuristic optimization algorithms," *Artificial Intelligence Review*, vol. 47, no. 4, pp. 417–462, Apr 2017. [Online]. Available: <https://doi.org/10.1007/s10462-016-9486-6>
43. S. H. Sedighy, A. R. Mallahzadeh, M. Soleimani, and J. Rashed-Mohassel, "Optimization of printed yagi antenna using invasive weed optimization (iwo)," *IEEE Antennas and Wireless Propagation Letters*, vol. 9, pp. 1275–1278, 2010.
44. S. Pal, A. Basak, S. Das, and A. Abraham, "Linear antenna array synthesis with invasive weed optimization algorithm," in *2009 International Conference of Soft Computing and Pattern Recognition*, 2009, pp. 161–166.
45. A. I. Hafez, H. M. Zawbaa, E. Emary, H. A. Mahmoud, and A. E. Hassanien, "An innovative approach for feature selection based on chicken swarm optimization," in *2015 7th International Conference of Soft Computing and Pattern Recognition (SoCPaR)*, 2015, pp. 19–24.
46. G. Shen, Y. Liu, G. Sun, T. Zheng, X. Zhou, and A. Wang, "Suppressing sidelobe level of the planar antenna array in wireless power transmission," *IEEE Access*, vol. 7, pp. 6958–6970, 2019.
47. S. Liang, Z. Fang, G. Sun, Y. Liu, G. Qu, and Y. Zhang, "Sidelobe reductions of antenna arrays via an improved chicken swarm optimization approach," *IEEE Access*, vol. 8, pp. 37 664–37 683, 2020.
48. S. Liang, Z. Fang, G. Sun, Y. Liu, X. Zhao, G. Qu, Y. Zhang, and V. C. M. Leung, "Jssa: Joint sidelobe suppression approach for collaborative beamforming in wireless sensor networks," *IEEE Access*, vol. 7, pp. 151 803–151 817, 2019.

49. G. Sun, Y. Liu, S. Liang, Z. Chen, A. Wang, Q. Ju, and Y. Zhang, "A sidelobe and energy optimization array node selection algorithm for collaborative beamforming in wireless sensor networks," *IEEE Access*, vol. 6, pp. 2515–2530, 2018.
50. A. K. Jain, S. C. Srivastava, S. N. Singh, and L. Srivastava, "Bacteria foraging optimization based bidding strategy under transmission congestion," *IEEE Systems Journal*, vol. 9, no. 1, pp. 141–151, 2015.
51. B. B. Mangaraj, S. K. Mohanty, and S. Hota, "Performance evaluation of two popular antennas designed using a bacteria foraging algorithm," *Engineering Science and Technology, an International Journal*, vol. 19, no. 4, pp. 1788 – 1800, 2016. [Online]. Available: <http://www.sciencedirect.com/science/article/pii/S2215098616304256>
52. F. Li, W. Ji, S. Tan, Y. Xie, X. Guo, H. Liu, and Y. Yao, "Quantum bacterial foraging optimization: From theory to mimo system designs," *IEEE Open Journal of the Communications Society*, vol. 1, pp. 1632–1646, 2020.
53. P. Baumgartner, T. Bauernfeind, O. Bíró, A. Hackl, C. Magele, W. Renhart, and R. Torchio, "Multi-objective optimization of yagi–uda antenna applying enhanced firefly algorithm with adaptive cost function," *IEEE Transactions on Magnetics*, vol. 54, no. 3, pp. 1–4, 2018.
54. T. Bauernfeind, P. Baumgartner, O. Bíró, A. Hackl, C. Magele, W. Renhart, and R. Torchio, "Multi-objective synthesis of nfc-transponder systems based on peec method," *IEEE Transactions on Magnetics*, vol. 54, no. 3, pp. 1–4, 2018.
55. A. Darvish and A. Ebrahimzadeh, "Improved fruit-fly optimization algorithm and its applications in antenna arrays synthesis," *IEEE Transactions on Antennas and Propagation*, vol. 66, no. 4, pp. 1756–1766, 2018.
56. W. Li, Y. Zhang, and X. Shi, "Advanced fruit fly optimization algorithm and its application to irregular subarray phased array antenna synthesis," *IEEE Access*, vol. 7, pp. 165 583–165 596, 2019.
57. S. K. Goudos, T. V. Yioultis, A. D. Boursianis, K. E. Psannis, and K. Siakavara, "Application of new hybrid jaya grey wolf optimizer to antenna design for 5g communications systems," *IEEE Access*, vol. 7, pp. 71 061–71 071, 2019.
58. A. Boursianis, K. Patakakis, S. K. Goudos, M. Salucci, and A. Massa, "Phased antenna array design using shuffled frog-leaping algorithm," in *2018 IEEE International Symposium on Antennas and Propagation USNC/URSI National Radio Science Meeting*, 2018, pp. 1845–1846.
59. R. Wang and Y. Jiao, "Synthesis of sparse linear arrays with reduced excitation control numbers using a hybrid cuckoo search algorithm with convex programming," *IEEE Antennas and Wireless Propagation Letters*, vol. 19, no. 3, pp. 428–432, 2020.
60. G. Sun, Y. Liu, Z. Chen, S. Liang, A. Wang, and Y. Zhang, "Radiation beam pattern synthesis of concentric circular antenna arrays using hybrid approach based on cuckoo search," *IEEE Transactions on Antennas and Propagation*, vol. 66, no. 9, pp. 4563–4576, 2018.
61. A. Deb, J. S. Roy, and B. Gupta, "A differential evolution performance comparison: Comparing how various differential evolution algorithms perform in designing microstrip antennas and arrays," *IEEE Antennas and Propagation Magazine*, vol. 60, no. 1, pp. 51–61, 2018.
62. Z. Shao, L. Qiu, and Y. P. Zhang, "Design of wideband differentially fed multilayer stacked patch antennas based on bat algorithm," *IEEE Antennas and Wireless Propagation Letters*, vol. 19, no. 7, pp. 1172–1176, 2020.
63. S. Vakilinia, H. Elbizaee, and B. Heidarpour, "Keep pets and elephants away: Dynamic process location management in 5g zoo," in *2017 IEEE 86th Vehicular Technology Conference (VTC-Fall)*, 2017, pp. 1–7.

64. A. Chakraborty, G. Ram, and D. Mandal, "Optimal pulse shifting in timed antenna array for simultaneous reduction of sidelobe and sideband level," *IEEE Access*, vol. 8, pp. 131 063–131 075, 2020.
65. R. Wang and Y. Jiao, "Synthesis of wideband rotationally symmetric sparse circular arrays with multiple constraints," *IEEE Antennas and Wireless Propagation Letters*, vol. 18, no. 5, pp. 821–825, 2019.
66. F. Zhang, W. Jia, and M. Yao, "Linear aperiodic array synthesis using differential evolution algorithm," *IEEE Antennas and Wireless Propagation Letters*, vol. 12, pp. 797–800, 2013.
67. R. Rao, V. Savsani, and D. Vakharia, "Teaching–learning-based optimization: A novel method for constrained mechanical design optimization problems," *Computer-Aided Design*, vol. 43, no. 3, pp. 303 – 315, 2011. [Online]. Available: <http://www.sciencedirect.com/science/article/pii/S0010448510002484>
68. S. K. Goudos, M. Deruyck, D. Plets, L. Martens, K. E. Psannis, P. Sarigiannidis, and W. Joseph, "A novel design approach for 5g massive mimo and nb-iot green networks using a hybrid jaya-differential evolution algorithm," *IEEE Access*, vol. 7, pp. 105 687–105 700, 2019.
69. F. Zadehparizi and S. Jam, "Increasing reliability of frequency-reconfigurable antennas," *IEEE Antennas and Wireless Propagation Letters*, vol. 17, no. 5, pp. 920–923, 2018.
70. H. Gao, Y. Su, S. Zhang, and M. Diao, "Antenna selection and power allocation design for 5g massive mimo uplink networks," *China Communications*, vol. 16, no. 4, pp. 1–15, 2019.
71. Q. Han, Y. Zhang, Z. Yang, W. Long, and Z. Liang, "Antenna array aperture resource management of opportunistic array radar for multiple target tracking," *IEEE Access*, vol. 8, pp. 228 357–228 368, 2020.
72. P. Gu, Z. He, J. Xu, K. W. Leung, and R. S. Chen, "Design of wide scanning sparse planar array using both matrix-pencil and space-mapping methods," *IEEE Antennas and Wireless Propagation Letters*, vol. 20, no. 2, pp. 140–144, 2021.
73. J. Yang, L. Luo, K. Yang, and Y. Zhang, "Ultrasonic phased array sparse tfm imaging based on virtual source and phase coherent weighting," *IEEE Access*, vol. 8, pp. 185 609–185 618, 2020.
74. S. Fang, W. Li, Z. Xue, and W. Ren, "Synthesis of distributed array consisting of two subarrays via hybrid method of differential evolution optimization and convex optimization," *IEEE Antennas and Wireless Propagation Letters*, vol. 20, no. 2, pp. 125–129, 2021.
75. F. Liu, Y. Liu, F. Han, Y. Ban, and Y. Jay Guo, "Synthesis of large unequally spaced planar arrays utilizing differential evolution with new encoding mechanism and cauchy mutation," *IEEE Transactions on Antennas and Propagation*, vol. 68, no. 6, pp. 4406–4416, 2020.
76. F. Neri and C. Cotta, "Memetic algorithms and memetic computing optimization: A literature review," *Swarm and Evolutionary Computation*, vol. 2, pp. 1 – 14, 2012. [Online]. Available: <http://www.sciencedirect.com/science/article/pii/S2210650211000691>
77. X. Zhang, M. Lin, X. Zhang, and Y. Li, "The design of microstrip array antenna and its optimization by a memetic method," *IEEE Access*, vol. 7, pp. 96 434–96 443, 2019.
78. M. Yao, M. Sohul, V. Marojevic, and J. H. Reed, "Artificial intelligence defined 5g radio access networks," *IEEE Communications Magazine*, vol. 57, no. 3, pp. 14–20, 2019.

79. L. Kouhalvandi, M. Pirola, and S. Ozoguz, "Automated two-step power amplifier design with pre-constructed artificial neural network," in *2020 43rd International Conference on Telecommunications and Signal Processing (TSP)*, 2020, pp. 617–620.
80. O. Elijah, C. Y. Leow, T. A. Rahman, S. Nunoo, and S. Z. Iliya, "A comprehensive survey of pilot contamination in massive mimo—5g system," *IEEE Communications Surveys Tutorials*, vol. 18, no. 2, pp. 905–923, 2016.
81. M. Boloursaz Mashhadi and D. Gündüz, "Deep learning for massive mimo channel state acquisition and feedback," *Journal of the Indian Institute of Science*, vol. 100, no. 2, pp. 369–382, Apr 2020. [Online]. Available: <https://doi.org/10.1007/s41745-020-00169-2>
82. M. Khani, M. Alizadeh, J. Hoydis, and P. Fleming, "Adaptive neural signal detection for massive mimo," 2019.
83. J. H. Kwon, J. Cho, B. Yu, S. Lee, I. Jung, C. Hwang, and Y. C. Ko, "Spectral and energy efficient power allocation for mimo broadcast channels with individual delay and qos constraints," *Journal of Communications and Networks*, vol. 22, no. 5, pp. 390–398, 2020.
84. K. Kim, J. Lee, and J. Choi, "Deep learning based pilot allocation scheme (dl-pas) for 5g massive mimo system," *IEEE Communications Letters*, vol. 22, no. 4, pp. 828–831, 2018.