

Modelling a fifth-generation bidirectional low temperature district heating and cooling (5GDHC) network for nearly Zero Energy District (nZED)

Original

Modelling a fifth-generation bidirectional low temperature district heating and cooling (5GDHC) network for nearly Zero Energy District (nZED) / Bilardo, M., Sandrone, F., Zanzottera, G., Fabrizio, E.. - In: ENERGY REPORTS. - ISSN 2352-4847. - 7:(2021), pp. 8390-8405. [[10.1016/j.egy.2021.04.054](https://doi.org/10.1016/j.egy.2021.04.054)]

Availability:

This version is available at: 11583/2941578 since: 2021-11-30T12:58:59Z

Publisher:

Elsevier Ltd

Published

DOI:[10.1016/j.egy.2021.04.054](https://doi.org/10.1016/j.egy.2021.04.054)

Terms of use:

This article is made available under terms and conditions as specified in the corresponding bibliographic description in the repository

Publisher copyright

(Article begins on next page)

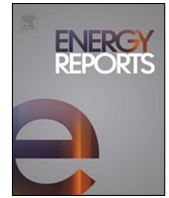

Research paper

Modelling a fifth-generation bidirectional low temperature district heating and cooling (5GDHC) network for nearly Zero Energy District (nZED)

Matteo Bilardo^{a,*}, Federico Sandrone^b, Guido Zanzottera^c, Enrico Fabrizio^a

^a TEBE Research Group, Department of Energy, Politecnico di Torino, Italy

^b Coesa s.r.l., Torino, Italy

^c Ai Studio s.r.l., Torino, Italy

ARTICLE INFO

Article history:

Received 31 December 2020

Received in revised form 29 April 2021

Accepted 30 April 2021

Available online 1 June 2021

Keywords:

Fifth district heating and cooling

Low-enthalpy thermal network

5GDHC

Smart thermal grid

Simulation-aided design

District network modelling

Active prosumer

Waste heat recovery

ABSTRACT

Current sustainability challenges place entire communities at the centre of the energy revolution, rather than individual buildings. The need to develop energy-efficient and low-carbon economies lies at the heart of fifth-generation district heating and cooling (5GDHC) networks. The potential of these networks is represented by a lower working temperature close to the ground temperature, usually between 10 and 25 °C. Thanks to this feature, the network presents optimal conditions to be used as a heat source for reversible heat pumps. 5GDHC networks provide users with a fundamental active role, giving the possibility of extracting and releasing energy into the thermal network, while producing heating and cooling simultaneously. The integration of renewable sources and reduced heat losses are added values to be taken into consideration. Given the limited application of 5GDHC networks, this paper aims to evaluate the energy advantages of coupling several users within a bidirectional fifth-generation network based on the integration of reversible heat pumps with on-site production by renewable sources and waste energy recovery. An integrated model of 5GDHC network with buildings was developed in order to meet the energy needs of a neighbourhood made up of users with different energy profiles throughout a whole year. To enhance future applications, the energy performance of the 5GDHC network model was studied through a simulation tool. An hourly numerical calculation tool was developed to simulate the behaviour of the network and the users' response over an annual period, estimating the energy shared between users during both the heating and cooling seasons. The results obtained are presented not only in terms of energy exchanged in the network, but also in the form of performance indexes of the individual users, identifying advantageous combinations between the users for future design developments of these systems. The outcomes of this paper highlight the integration of established technologies into fifth-generation thermal networks, with a view to a future development of nearly Zero Energy Districts (nZED).

© 2021 Published by Elsevier Ltd. This is an open access article under the CC BY-NC-ND license (<http://creativecommons.org/licenses/by-nc-nd/4.0/>).

1. Introduction

The energy transition that characterized the last century was crucial for the entry of new production technologies such as renewable sources and nuclear energy (REN21, 2018). The use of new energy sources has always had as its main objective the reduction of the energy impact on the environment, both in terms of greenhouse gas emissions and production efficiency. Climate change, which is now more than ever a consolidated reality, must however clash with an increasingly energy-intensive world, which is unlikely to decrease its consumption in the coming decades (Interantional Energy Agency, 2016).

To face this problem, the European Union has already set its objectives for a few years in order to achieve the target of decarbonization by 2050, identifying the fundamental role of the energy system, which could represent 14.6% of the European GDP (European Commission, 2012b). In this scenario we must also consider an expansion of urban centres, typically with higher consumption than rural areas, where 68% of the population will concentrate by 2050 (United Nations, D. of E. and S. A., 2018). The future development of urban centres will therefore be essential to achieve the set energy goals. In Europe, the only two sectors of households and industry account for 51.8% of final energy consumption (EUROSTAT, 2020). The importance of energy needs of buildings has been repeatedly addressed by the European Commission, which has issued recent directives within the EPBD (Energy Performance of Building Directive) package (European

* Corresponding author.

E-mail address: matteo.bilardo@polito.it (M. Bilardo).

Nomenclature

Symbols

Q	Heating or cooling thermal energy [kWh]
E	Electrical energy [kWh]
I	Performance index [–]
η	Efficiency [–]
T	Temperature [°C]
\dot{m}	Mass flow rate [ks/s]
H	Head [m]
c_p	Specific Heat [kJ/(kg K)]

Subscripts/Superscripts

int	Integration
th	Thermal
el	Electric
ground	Ground
s	Supply
r	Return
in	Inlet
out	Outlet
w	Water
user	User of the network
need	Thermal need of a building
pump	Pumping
HP	Heat Pump
int	Integration
el	Electrical
source	Source (network) side
ext	External

Acronyms/Abbreviations

DHC	District Heating and Cooling
5GDHC	Fifth generation district heating and cooling
COP	Coefficient of performance
EER	Energy efficiency ratio
HCD	Heating, Cooling and Domestic hot water
WSHP	Water Source Heat Pump
PE	Primary Energy
PEF	Primary Energy Factor

Union, 2018; European Commission, 2012a). However, the design and construction of increasingly efficient buildings is not enough to contain global energy consumption. This is also shown by the fact that, while heating needs will tend to decrease, the demand for space cooling will continuously increase in the coming years. In addition to more sustainable energy production, a more rational use of current resources is therefore necessary (Connolly et al., 2014).

1.1. Motivation

Examples of a more rational approach to the exploitation of energy resources can be identified in the various energy cooperatives and communities that are spreading in Europe (Paiho and Reda, 2016). Although the purposes may be different according to each reality, the common goal of an energy community

remains to minimize energy waste and maximize energy self-consumption, trying to create groups of users that can support their needs (Lowitzsch et al., 2020). While from the point of view of electricity, the examples of smart grids are numerous and more widespread (Zhang et al., 2018), on the thermal side the problem is different. The most common example of thermal grids shared by several users are traditional district heating networks, through which the heat is produced centrally and then distributed to the various users with a heat transfer fluid (Talebi et al., 2016; Mazhar et al., 2018), forcing a monodirectional way of heat transfer (from a producer to a user). Moving on space cooling, the thermal networks capable of satisfying the cooling needs are still not widespread in most European countries (Lund et al., 2018a, 2014). A promising solution to meet the thermal needs on a district scale is represented by the new generation district thermal grids, capable of satisfying both heating and cooling needs within a single infrastructure (von Rhein et al., 2019). This type of smart thermal grid has not yet been clearly defined and requires a more detailed analysis, which will be discussed in the next paragraph.

The main motivation for pushing research towards a new way of managing and exploiting thermal energy networks is to decentralize the thermal production of traditional district heating networks to make users an active part of energy production and consumption. This process can be carried out by lowering the thermal levels, minimizing thermal waste and making the heat produced available to other users (Chmutina and Goodier, 2014).

1.2. New generation district heating and cooling: definition inconsistencies

Defining a district heating and cooling (DHC) network is not trivial. Recent studies that have focused on the smart thermal grid concept have often created some confusion in their definitions, using several descriptions and acronyms to describe the behaviour of a new-generation thermal grid. As early as 2014, Lund et al. (2014) had given a clear overview of the district heating generations, starting from the very first generation (1GDH), characterized by a heat distribution network based on high temperature steam. Over the years, the common trend was to lower the distribution temperature of the network and integrate it with new technologies, such as renewables, waste heat recovery or micro-CHP, that would gradually emerge on the market. In the second and third generation of district heating (2GDH and 3GDH) steam has been replaced by pressurized hot water in combination with the industrial production of prefabricated substations, allowing the spread of this technology in many developed countries. With the fourth generation of district heating (4GDH), the thermal level of the network has further decreased, allowing the integration of renewable sources deriving from solar or geothermal energy. The real revolution of these networks was the active participation of individual users, who for the first time were able to integrate their thermal energy production within the network and to share it with other users (Lund et al., 2018b).

The common feature of all past generations of thermal grids also represents their limitation, which is the possibility of supplying exclusively heating thermal energy to connected users. Furthermore, all existing district heating networks are heavily dependent on centralized heat production, which in most cases occurs in traditional heating or CHP plants (Levihn, 2017). The new generation of thermal grids, which can be recognized as the fifth generation (5G), differs from the previous generations by the following characteristics:

- Possibility to distribute heating and cooling simultaneously. For this reason, the fifth generation of thermal grids is recognized as district heating and cooling (DHC);

Table 1
Thermal grids generations, partially adapted from Lund et al. (2014).

Gen	Name	Temperature	Features
1G	First generation district heating (1GDH)	<200 °C	<ul style="list-style-type: none"> • Steam as heat carrier • Coal-fired systems • Concrete pipes
2G	Second generation district heating (2GDH)	>100 °C	<ul style="list-style-type: none"> • Pressurized hot-water • Fossil-based centralized plants
3G	Third generation district heating (3GDH)	~100 °C	<ul style="list-style-type: none"> • Pressurized hot-water • Industrialized substations • Heat storage integration • High-efficient CHP plants
4G	<ul style="list-style-type: none"> • Fourth generation district heating (4GDH) • Low-temperature district heating (LTDH) • Low-enthalpy systems 	50–80 °C	<ul style="list-style-type: none"> • Low-temperature water • Renewables integration • Heat waste recovery
5G	<ul style="list-style-type: none"> • Fifth generation district heating (5GDH) • District heating and cooling (DHC) • Decentralized heat pump smart grid • Water loop heat pumps systems • Cold District Heating (CDH) • Bidirectional low temperature networks 	<30 °C	<ul style="list-style-type: none"> • Heating and cooling supply • Reversible heat pumps substations • Decentralized production • Heat sharing metering

- Low floating operation temperatures, usually very close to the surrounding ground temperature;
- Active and economically recognized participation of users for their behaviour and impact on the network, with new possible business model opportunities for the energy market.

The new concept of 5GDHC is closely linked to that of the water source heat pump (WSHP) (Arabkoohsar and Alsagri, 2020). These new thermal grids provide users with a low temperature energy source that can be used by reversible water source heat pumps to meet the user's heating or cooling needs. Depending on its use, the network will act as a heat source during the heating phase, in which the heat is extracted from the network or as a heat sink during the cooling phase, in which the heat is introduced into the network. These two phases can take place simultaneously and independently for each user, and the heat necessary for the operation of the heat pump is not released into the environment but recovered within the network. The concept of this network is advantageous because it allows water source heat pumps to work in optimal conditions compared to the most common air source heat pumps (ASHP). This solution allows in fact to increase the coefficient of performance (COP), since the temperature of the network can be kept at a higher temperature of the outside air in the winter period or lower in the summer period, reducing the ΔT between the heat pump evaporator and compressor.

On the other hand, this new solution makes the substations technologically more complicated, which will no longer be represented by a simple heat exchanger but by water source heat pumps, resulting in higher initial investment. The concept of the 5GDHC, despite being relatively new, has already been the subject of several academic studies and pilot projects in Europe, which are exploring its benefits on the field. However, while sharing a similar idea about how thermal grids work, recent studies have often used several acronyms to identify 5GDHC, creating some confusion in the literature. Similar 5GDHC concept have been proposed through various descriptions (Buonomano et al., 2012; Wirtz et al., 2020). To provide an overview of the evolution of thermal grids, Table 1 collects a summary of the DH generations. The different definitions to describe a 5GDHC have been put together. For each DH generation, the main technological features have been reported.

A detailed review on the development and dissemination of this technology has been prepared by Buffa et al. (2019). The

authors have also published for the first time a common definition of 5GDHC that incorporates all the characteristics shared by recent studies on the subject.

1.3. State of the art on 5GDHC

Many European countries have developed a fair interest in potential new generation thermal grids applications and a number of research projects are currently underway. Since the realization of 5GDHC involves the adoption of existing and established technologies on the market, it was immediately possible to carry out experimental projects. The various early applications of 5GDHC can be divided into two main groups:

- The thermal networks created by the need of a single user to satisfy simultaneous heating and cooling needs of the conditioned spaces (e.g. supermarkets), developing a distribution network of a heat source to minimize the purchase of external energy. In the literature, several studies have focused on this type of design approach, often trying to determine the best network configuration that would lead to the lowest electrical operation cost (Coccia et al., 2019).
- Pilot projects, often financed by European or governments funds, which allow an exchange and energy sharing of several different users, trying to create a larger thermal network. In this case, many studies are producing interesting results, such as those described by Rezaie and Rosen (2012), where the authors propose exergy analysis as a valid strategy to assess the efficiency of thermal grids.

Although based on the same principle of 5GDHC, these two approaches have substantial differences. In the first case, since the network consists of a single user with different energy needs, the design and the realization processes certainly requires a lesser effort, since a reasonable estimate of the thermal loads of the network is known a priori. The case of a network made up of several users, on the other hand, is more complicated, both because it is not obvious to have an accurate evaluation of the energy demand, and because the network has to cover greater distances, usually in the order of kilometres to serve entire neighbourhoods. One of the main limitations that slows down the spread of 5GDHC on a large scale is therefore the high initial investment, not so much in terms of network infrastructure (compared to traditional DH) but rather in the installation of substations, which need WSHPs, definitely more expensive than traditional heat exchangers. The

sizing and design represent a further effort for this type of thermal grids, and their limited diffusion is not appealing for the investment of large energy utilities.

In Europe, Germany accounts for more than 30% of the 5GDHC active pilot projects (Buffa et al., 2019). It is interesting to compare this result with the distribution of Energy Communities in Europe, where Germany is again the first country in terms of number of energy-sharing realities (Bauwens et al., 2016), indicating how these two facts often coexist and grow concurrently. An existing success story is located in The Hague, Netherland, where a complex of 789 housing units equipped with WSHP has been integrated into a shared thermal network which maintains an annual temperature between 11 °C and 18 °C (Department of Energy & Climate Change, 2016). A further HVAC system operating in Tigné Point, Malta, uses 340 residential users, 50 offices and a shopping mall to distribute heating and cooling through a thermal network managed by water source heat pumps (Mitsubishi S.p.A., 2016). In this case, the installed power is approximately 6.5 MW and 4.8 MW for heating and cooling respectively.

1.4. State of the art on 5GDHC numerical models

Preliminary design and equipment sizing usually represent a starting issue in developing a functioning and efficient 5GDHC network. The experience gained in pilot projects has not yet made it possible to develop 5th generation district heating and cooling networks in larger urban contexts such as existing residential or industrial districts. To fill this gap, in recent years several research projects have focused on the development of numerical models capable of simulating the behaviour of 5GDHC, providing preliminary tools for the numerical evaluation of 5GDHC networks energy performance.

Recently, Zajacs et al. (2020) proposed a model developed in TRNSYS able to simulate the behaviour of a heat pump integrated in an existing district heating network. The heat pump was intended to use the return line of the network as a heat source and the supply line as a heat sink. The authors have shown how the integration of heat pumps into existing thermal networks can generate benefits in terms of primary energy and CO₂ emissions. In 2018, Bünning et al. (2018) developed an agent-based model control to optimize the set point temperature of a bidirectional district heating and cooling network. After developing their own model in Modelica environment, the authors studied the effect of the control model on two existing scenarios, comparing the performance with respect to traditional solutions, and obtaining a decrease in emissions of the entire network by 26%. An innovative approach was investigated by Testi et al. (2020): in this work, a stochastic methodology for the optimal integration of decentralized heat pumps in a smart thermal and electric micro-grid was developed. The authors demonstrated how the integration of heat pumps into an existing thermal network can reduce operational costs. The study of the topology of thermal networks is a further aspect that is supporting the development of 5GDHC networks: in a recent study, Sommer et al. (2020) simulated the behaviour of a novel network topology for simultaneous heating and cooling, developing a numerical model in Modelica. In this study a hydraulic decoupling of the substations has been proposed, reducing the initial investment costs as well as the operational costs. The interest in the development of simulation models for district heating and cooling networks is also demonstrated by several EU projects focused on this topic: within the AMBASSADOR project, del Hoyo Arce et al. (2018) compared different numerical solutions to quickly and effectively model next-generation thermal networks comparing the Modelica, Apros[®] and IDA-ICE[®] environments. Also in the context of the EU LIFE4HeatRecovery project, Calixto et al. (2021) developed a dynamic hourly model of an existing neutral temperature district heating network, both through an approximate and detailed approach, adopting the Octave environment. Finally, more broad-based numerical models

have also been developed, capable of integrating fifth-generation thermal networks with flexible electrical networks, where the control of heat pumps, electric vehicles and storage systems using artificial intelligence allows for maximization revenue and carbon saving (Revesz et al., 2020).

1.5. Aim of the work

After considering the energy and economic potential of the 5GDHC grids and after taking into consideration the recent developments of this concept, it is evident that their large-scale diffusion is limited by the lack of more detailed analyses capable of examining multiple scenarios of possible development. The studies carried out so far focus on quantitative analyses on a district scale, with a low level of detail on the individual users connected to the network. On the other hand, the more detailed analyses of 5GDHC projects carried out in the literature are limited to single case studies and often not very reliable for comparisons with similar solutions. In this scenario, where the configuration of the thermal network makes each case study unique, it is necessary to develop new, more flexible tools capable of highlighting the potential of 5GDHC grids.

The aim of this work is therefore the development of a new 5GDHC grid model based on the adoption of WSHP, capable of simulating the behaviour of a fifth generation thermal network regardless of the desired combination of users. The developed model acts as a flexible tool able to simulate any combination of users connected to the network, providing a pre-design tool useful for estimating the energy flows within the entire grid. The aim is to develop a complete design-aided tool for carrying out preliminary assessments of 5GDHC networks. The approach of the model is extremely practical and the level of detail is that of the single building, which corresponds to a substation of the network powered by a WSHP.

In summary, the main objective of this work is to develop a 5GDHC network model able to:

- Generate an arbitrary network configuration, with infinite possible simulation scenarios;
- Carry out pre-sizing estimations for a 5GDHC;
- Study the energy flows exchanged within a thermal network, with a level of detail of the individual building;
- Provide energy analysis results of the generated grid.

The approach of the model is design-oriented and acts as a starting tool for future more detailed analyses on 5GDHC, in order to push forward their diffusion.

2. Methodology

The developed model simulates the energy behaviour of a 5GDHC. After establishing the network configuration, in terms of distance, users and climatic conditions, the grid is simulated to fulfil the connected thermal loads. The model can be considered modular, since it allows the addition or removal of any type of user without having to change the simulation logics. The model is based on an hourly dynamic simulation: at each hour of the year, the network energy balance equations are solved and subsequently implemented in solving the next time-step. A combination of the MATLAB[®] and Simulink[®] development platforms has been adopted for the definition of the balance equations and control logic of the network.

2.1. Model framework

Before starting the simulation process, the model requires the definition of some input parameters, in order to define the users connected to the grid, the simulation weather conditions and the spatial distances between the users. A first pre-processing

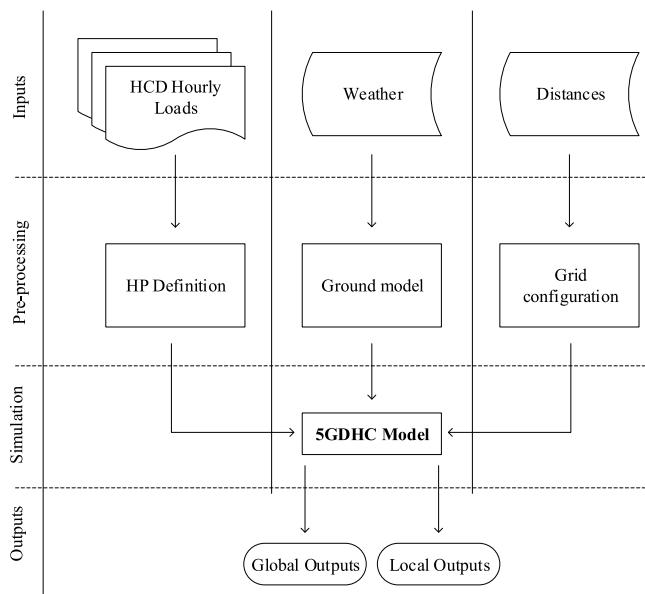

Fig. 1. Framework methodology.

step on the input data generates some intermediate results, such as the definition of the ground model (based on the weather and location data), the grid configuration and the sizing of the WSHP to be associated with the users. Subsequently, the thermal network undergoes the hourly simulation to generate both global outputs relating to the general performance of the network, and local results associated with the individual users. The diagram in Fig. 1 reports the general framework of the model.

A more detailed explanation of the blocks of the model framework follows.

Inputs

- **Weather/Location:** the weather data required by the model consist of the dry bulb temperature trend of the outdoor air, on an hourly basis. These data are integrated with the physical parameters that characterize the ground of the considered location, such as density, average thermal conductivity, heat capacity, porosity and liquid content.
- **Distance:** the relative distances between the various users are necessary for the study of the spatial configuration of the grid and for the subsequent analysis of pressure and temperature losses in the network pipeline.
- **Users:** each user is defined by three energy demand profiles for heating (H), cooling (C) and domestic hot water (D), on an hourly basis. In addition to the energy demand profiles, each user can also integrate into the network hourly waste energy profiles deriving from other processes, not attributable to HCD (heating, cooling and domestic hot water) services.

Pre-processing

- **Ground model:** a model of ground losses (heat and pressure) is generated to take into account the heat flow between the network and the surrounding ground. In this phase, the parameters defined in the Weather/Location inputs are processed and integrated with the physical parameters of the pipes used in the network infrastructure;
- **Grid configuration:** based on the distances entered, the geometry of the network is processed to evaluate the grid total extension and the relative position of the users;
- **HP definition:** starting from the hourly demand for HCD, the model automatically assigns to each user a customized WSHP, according to the required peak powers. De-

pending on the power size identified, performance curves are associated to dynamically evaluate the performance of the heat pumps. The performance curves have been implemented from the technical sheets currently on the market and made available by the WSHP manufacturers. The performance evaluation varies according to the user energy need: each WSHP will have three specific curves to evaluate the COP in the heating phase, the COP for DHW production and the EER in the cooling phase.

Outputs

- **Global outputs** represent the energy results that concern the balance of the entire network, such as the total energy imported or exported from the network, the energy required for pumping and some general performance indicators (see following sections);
- **Local outputs** are represented by the dynamic trends at the individual substations and concern the performance of the individual users, as well as their ability to interact with the network.

2.2. Model description

The model developed represents a low temperature DHC network where the temperature of the heat distribution medium is between 5 °C and 20 °C, depending on the season or the control strategies that can be implemented. Primary users are represented by substations with reversible heat pumps. The modelled network fits in the concept of bi-directionality, allowing users to exploit the distribution medium of the network both as a heat source and as a heat sink. The distribution network, consisting of a twin supply and return buried pipes, develops according to the ground layout and the users placement. Thanks to the distribution temperatures in the order of ambient temperature, the grid pipeline has been modelled with uninsulated polypropylene, a thermoplastic material with excellent mechanical and corrosion resistance properties. The lack of insulation allows a continuous heat exchange with the ground, increasing the thermal inertia of the system and taking advantage of the underground soil as a storage system. The substations for the heating and cooling delivery consist of reversible heat pumps interposed between the distribution network and the user emission system. Depending on the operation, the heat pump draws the fluid from the network and raises (cooling phase) or lowers (heating phase) the temperature. This process is controlled by the energy needs of the buildings connected to the network, which represented the main forcing function of the model. To keep the DHC network balanced, a central plant was modelled, consisting of an ideal heat generation and heat sink system, with the aim of keeping the network supply temperature at the set point defined by the grid management strategy. In addition, a pumping unit has been modelled, with the aim of moving the heat distribution medium inside the pipes and assessing the electrical energy required for pumping. For the model purpose, the central plant is an ideal system. However, in a real application of the network it could be replaced by any energy generation system (boiler, traditional chiller, seawater heat pump, etc.). In ideal operating conditions, the energy required from the central plant to keep the distribution medium at the set point temperature should be as low as possible. This ideal condition occurs when the network layout is composed of a group of diversified users, whose energy needs often follow opposite demand profiles. In such configuration, the heat rejected in the grid would compensate the heat extracted from the grid. For this reason, users coupling is a key factor in the design of these thermal networks. Fig. 2 represents a simplified diagram of the 5GDHC network, where the central plant, the

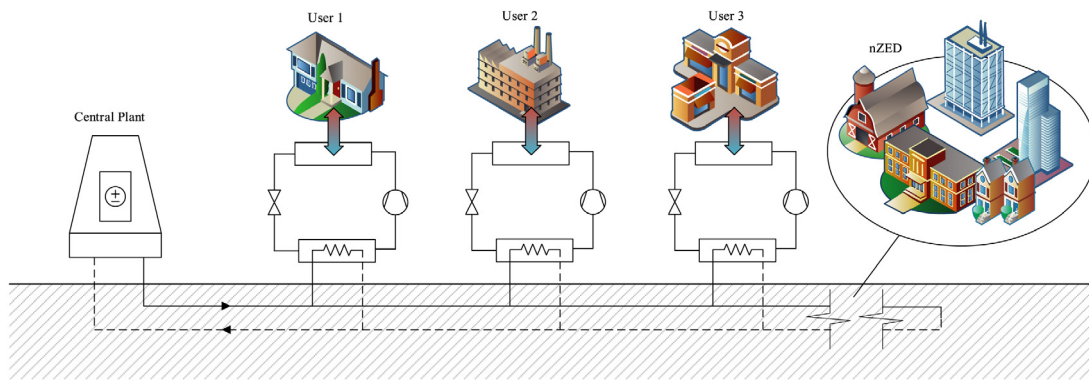

Fig. 2. 5GDHC network functional scheme.

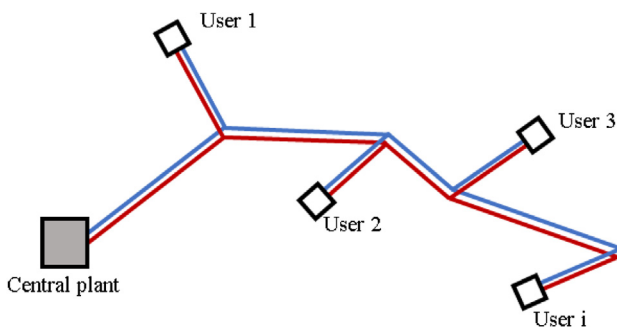

Fig. 3. Scheme of a radial topology DHC network.

users, the substations and the general infrastructure of the supply and return pipes are represented.

The proposed 5GDHC model can be associated with the sub-category of liquid loops (Fernández et al.), where a fluid heat medium distributes the thermal energy necessary for the functioning of WSHP. In the developed model the fluid used is simple water. The implementation of this concept offer the energy and economic advantages already stated, as also described by Revesz et al. (2020). The numerical model of the network was developed with a finite difference method, applying an hourly simulation timestep. For each hour of the year, the model simulates the local behaviour in each node of the network, evaluating the mass and energy balances. Using default data, the model warms up for 5 days to stabilize its thermodynamic conditions before starting the annual simulation. The following paragraphs analyse in detail the numerical model developed, starting from the topological definition of the network, and then describing the simulation modules that were implemented.

2.2.1. Grid topology

In a district heating and cooling network, the topology and characteristics of the piping are determined on the basis of the project location and the functions of the network. In this work, the network is designed with an uninsulated pipeline since the design temperature of the water loop is close to the ground temperature. Among the possible topologies of district energy grids are the radial, meshed and ring networks. Each of these solutions offers advantages depending on the function and purpose of the network (Pizzolato et al., 2018). The ring topology offers a good integration of different heat sources, while the meshed topology ensures high security on the heat supply. However, both of these solutions have higher investment costs than a radial grid topology, where usually the main heat source is unique (von Rhein et al., 2019). The proposed and analysed 5GDHC model makes it possible to develop and simulate a network with radial topology, where the buildings are connected in series by means of

a supply and return twin pipeline. Fig. 3 represents a schematic of the topology on which the model is based, where the coordinates in space are provided as input, depending on the geographic distribution of the buildings.

The advantage of the radial topology is the control over the supply temperature, which is not influenced by the users along the network, thus providing a constant supply temperature to each user. In fact, the effect of the user interaction with the grid is perceived only on the return pipe. This feature is particularly advantageous when installing WSHP, since it allows to optimize the operating point of the heat pump. Another advantage results in the ease of disjunction of each substation, which in case of maintenance or replacement can be excluded from the network without compromising its operation. The economic advantage of the radial topology is to minimize the costs of the initial investment, since the two twin pipes are buried during the same groundwork. However, the main disadvantages of the radial topology are the higher pressure losses across the pipeline and the difficulty of new users connection to an existing network.

2.2.2. Model components

The 5GDHC network model was developed by coupling different components with specific simulation functions. In this paragraph all the elements that make up the thermal network and allow its dynamic simulation will be examined. Each component of the model is represented by a simulation module that receives inputs and processes outputs, exchanging data with other modules. MATLAB® and Simulink were used as development environment for every simulation module. The simulation modules can be divided into two functional categories: the unique modules, that are modules repeated only once within the network, and block modules, which are repeated for each user connected to the network. The unique modules of the network are two: the central plant and the central pumping unit. The block components are four: the pipeline/ground module, the supply branch node, the return branch node and the WSHP. A set of block modules can be configured as an instance. The model was developed to simulate a customizable number of instances (i.e. users), making this simulation tool adaptable to different scenarios. Table 2 summarizes the main features of each component, reporting its main purpose, the inputs, the outputs produced and the physical governing equation. In the following paragraphs each module is analysed in more detail, while a general scheme that relates the different modules within the network is shown in Fig. 10.

1. Central plant Fig. 4

The purpose of the central plant is to restore the supply temperature to the set point value (T_s). The model does not define the type of heat source or sink adopted for this function, but only assess the hourly energy need to provide the desired set

Table 2
Summary of the main features of the simulation modules.

	#	Module	Objective	Inputs	Outputs	Equation
Unique modules	1	Central plant	Set point control	Temperature, flowrates	Integration energy need	(1)
	2	Central pumping unit	Flowrate control	Temperature, buildings energy need, network pressure drops	Flowrate	(2)
Block modules (instance)	3	Pipeline/ground model	Ground losses evaluation	Temperatures, soil and pipeline properties	Heat flow to the ground	(3), (4)
	4	WSHP	HP performances and energy need	Temperatures, flowrates, performance map and climatic curve	COP/EER and electrical need	(5), (6)
	5a	Supply branch node	Mass and energy balance	Temperatures, flowrates	Temperatures, flowrates	(7), (8)
	5b	Return branch node	Mass and energy balance	Temperatures, flowrates	Temperatures, flowrates	(7), (8)

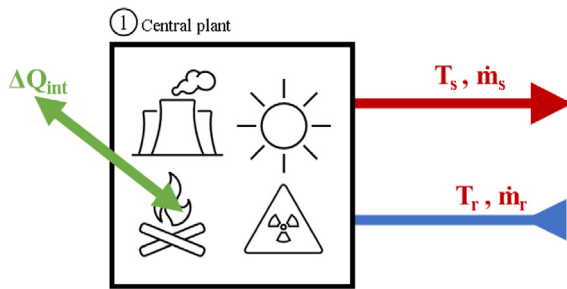

Fig. 4. Central plant model scheme.

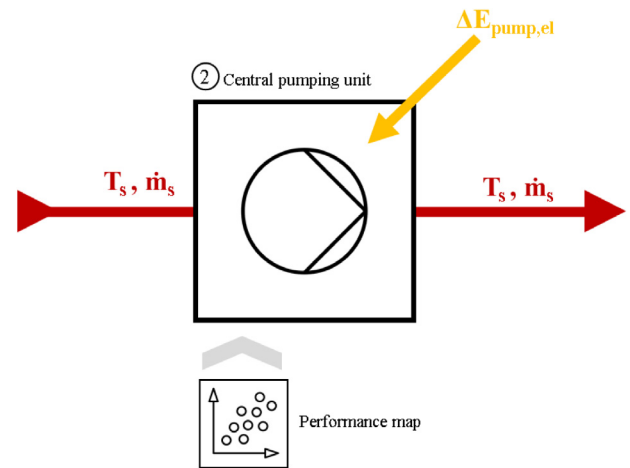

Fig. 5. Central pumping unit model scheme.

point to the network. The inputs necessary for the operation of this module are represented by the central plant inlet and outlet temperatures and flow rates, in addition to the thermophysical properties of the heat transfer fluid. The main output is the integration energy to be supplied/subtracted from the fluid mass flow. The balance Eq. (1) solved by the module is:

$$\frac{dQ_{int}}{dt} = \dot{m}_{s/r} * c_{p,w} * (T_s - T_r) [W] \quad (1)$$

where T_s is the supply set point temperature;
 T_r is the return temperature to the central plant;
 $\dot{m}_{s/r}$ are the coinciding supply and return flow rates;
 $c_{p,w}$ is the specific heat of water, adopted as heat transfer fluid;
 Q_{int} is the integration energy that must be supplied within the central plant.

2. Central pumping unit Fig. 5

The purpose of the central pumping unit is to ensure the necessary fluid flow inside the network. This simulation module receives as input the flow rate required by the network and the set point temperature and is able to estimate the pumping electricity consumption. In addition, the model also receives the pump performance map and the network head as an additional input. Network head is estimated according to the distributed and localized losses. Distributed losses are evaluated considering the distances between users and central plant, whereas localized losses are estimated ad constant values for each user substation. From these data the operating point of the pump, as well as its efficiency is evaluated. The equation Eq. (2), governing this module turns to be:

$$\frac{dE_{pump,el}}{dt} = \frac{\dot{m}_s * H}{\eta_p} [W] \quad (2)$$

where \dot{m}_s is the flow through the pump;
 H is the total head of the network;
 η_p is the efficiency of the pump;
 $E_{pump,el}$ is the energy needed for pumping.

3. Pipeline and ground model Fig. 6

The purpose of this simulation module is to estimate the heat flow exchanged between the supply and return pipes with the surrounding ground. This evaluation is made for both pipes and can lead to different results: a positive heat flow when the pipe releases heat to the ground, or negative when the opposite occurs. In this module, the ground is considered with infinite heat capacity and variable temperature. The undisturbed temperature of the soil (ASHRAE, 2019) varies during the year according to the climatic conditions and the thermophysical properties of the soil, according to the relation reported by Eq. (3):

$$T_{ground} = T_m + A_s e^{-z\sqrt{\frac{\pi}{\alpha\tau}}} \sin\left(\frac{2\pi(t - t_{lag})}{\tau} - z\sqrt{\frac{\pi}{\alpha\tau}}\right) [K] \quad (3)$$

where T_{ground} is the undisturbed temperature of the ground;
 T_m is the mean external temperature;
 A_s is the surface temperature amplitude;
 z is the depth;

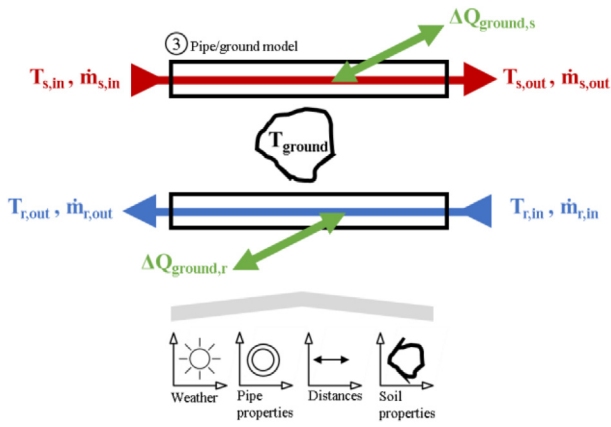

Fig. 6. Pipeline and ground model scheme.

α is the thermal diffusivity for soil;
 t is the julian date in days;
 t_{lag} is the phase lag of soil surface temperature in days.
 Consequently, the heat flux between the pipeline and the ground was evaluated using Eq. (4), applied for each section of piping that separates two nodes of the network.

$$\frac{dQ_{ground}}{dt} = \frac{(T_f - T_{ground})}{R_p} [W] \quad (4)$$

where Q_{ground} is the heat exchanged between the pipeline and the ground;

T_f is the fluid temperature;
 R_p is the pipeline thermal resistance.

4. Water Source Heat Pumps - WSHP Fig. 7

The purpose of the WSHP module is to simulate the operation of the heat pump under certain conditions. For each timestep this module returns the WSHP electrical need, as well as the heat exchanged with the network ($Q_{source/sink}$). The heat pump model is based on the performance map of the machine (both in summer and winter operation), defined according to the thermal load of the building. In the pre-processing phase, the model associates a specific heat pump with each building, based on the rated heating capacity ($\dot{Q}_{r,h}$) among 3 possible alternatives ($\dot{Q}_{r,h} < 30 \text{ kW}$, $30 < \dot{Q}_{r,h} < 100$, $\dot{Q}_{r,h} > 100$).

The further assumptions made to support the model are the thermal drops on the WSHP heat exchangers. A design ΔT of 5 °C has been set on both the source side and the user side, while the user supply temperature ($T_{user,in}$) is defined adopting a summer or winter climatic curve. To calculate the electricity use of the heat pump, the COP/EER is evaluated as a function of the working temperatures using the efficiency maps reported in Eq. (5), then the energy exchanged with the network ($Q_{source/sink}$) and the WSHP electrical need are calculated, using the building energy need as an input, as reported in Eq. (6). Finally, by setting the design temperature drop on the heat pump exchanger on the network side, it is possible to determine the flow rate required as heat source/sink to the user to meet its thermal load.

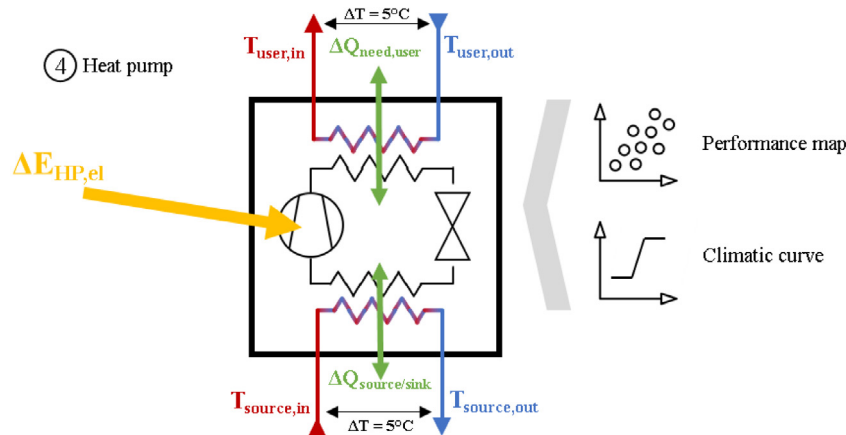

Fig. 7. WSHP model scheme.

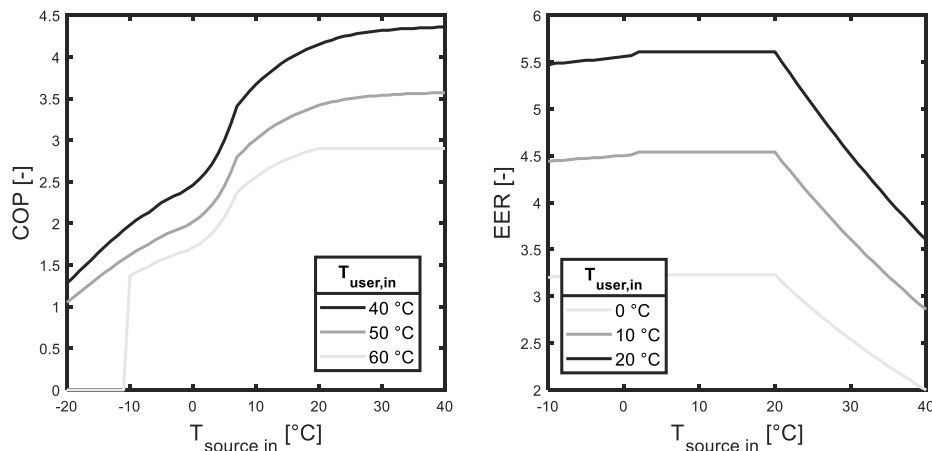

Fig. 8. Heat pump performance map.

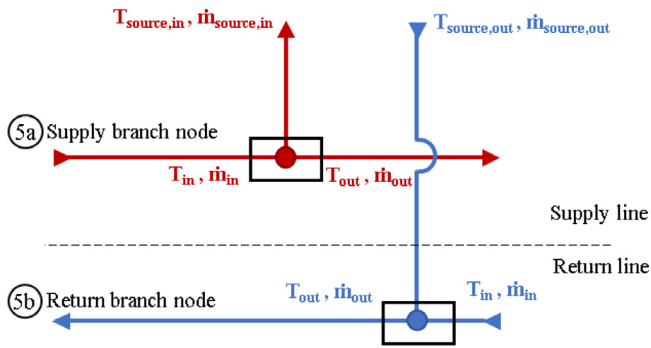

Fig. 9. WSHP model scheme.

A further simplification is due to the fact that the supply temperature to the users has always been considered suitable for working with low enthalpy emission terminals, such as low temperature radiant systems. The heat pumps COP and EER are therefore evaluated adopting performance maps implemented in the model. Fig. 8 reports the performance curves for a heat pump of the model.

$$COP/EER = f(T_{user,in}, T_{source,in}) [-] \quad (5)$$

where COP/EER are the heat pump performance coefficients;

$T_{user,in}$ is the water temperature supplied to the user;

$T_{source,in}$ is the water temperature from the 5GDHC.

$$\frac{dE_{HP,el}}{dt} = \frac{Q_{need,user}}{COP/EER} [W] \quad (6)$$

where $E_{HP,el}$ is the heat pump electrical need;

$Q_{need,user}$ is the user energy need;

5a /b. Supply and return pipe branching nodes Fig. 9

The supply and return branching nodes have the purpose of solving out the mass and energy balance at the points of the network where a user is connected and there is a flowrate or temperature variation in the network. These simulation modules perform a mass and energy balance for an open system for each simulation timestep, as reported by Eqs. (7) and (8), respectively. Each node of the network receives as input the flow rate and the temperature at the inlet and calculates the same quantities at the output of the node. For each i th instance of the 5GDHC model, both branching nodes will be simulated, using as inputs the flow rate and temperature values coming from the previous instance or WSHP module.

The branching nodes of the supply line are solved in sequential order, starting with the one closest to the central plant. The nodes of the return line are solved in reverse order, starting from the most distant node of the network.

$$\sum_{in} \dot{m}_{in} = \sum_{out} \dot{m}_{out} \left[\frac{kg}{s} \right] \quad (7)$$

$$\sum_{in} \dot{m}_{in} * C_{p,w} * T_{in} = \sum_{out} \dot{m}_{out} * C_{p,w} * T_{out} [W] \quad (8)$$

where: \dot{m}_{in} and \dot{m}_{out} are the inlet and outlet i th node, respectively;

T_{in} and T_{out} are the inlet and outlet temperatures of the i th node, respectively;

Fig. 10 provides an overall scheme of the 5GDHC model developed, including the individual simulation modules described above. From the diagram it is possible to deduce the modularity of the model, represented by the i th instance, which includes the 4 block modules. The potential of the developed model is

therefore represented by its high versatility and strong adaptation to multiple simulation scenarios, consisting of a variable number of buildings, arranged according to the project requirements.

2.3. Thermal grid performance indicators

The potential of the simulated network was assessed following two approaches. First, some global indicators have been identified in order to describe effectively several aspects of the network. The global results, reported as indexes, derive from the aggregate results obtained from the entire annual simulation, and therefore describe specific network performances averaged throughout the simulated year. The global indices used to analyse network performance are:

- Thermal efficiency, defined as the ratio between the useful thermal effect produced to users and the energy spent to achieve it:

$$\eta_{th} = \frac{Q_{need,user}}{E_{HP,el} + Q_{int}} [-] \quad (9)$$

where $Q_{need,user}$ is the total thermal energy need of the buildings, $E_{HP,el}$ is the electrical energy necessary for the operation of the WSHP and Q_{int} is the thermal energy of integration to the network produced at the central plant.

- Electric index, the amount of electricity needed to operate the network with respect to the total thermal needs of buildings:

$$I_{el} = \frac{E_{HP,el} + E_{pump,el}}{Q_{need,user}} [-] \quad (10)$$

where $E_{HP,el}$ is the total energy required by the WSHP, $E_{pump,el}$ is the electrical energy need for the pumping unit and $Q_{need,user}$ is the total thermal energy need of the buildings.

- External integration index, which indicates the percentage of thermal energy that must be integrated from the outside with respect to the total thermal requirement:

$$I_{int} = \frac{Q_{int}}{Q_{need,user}} [-] \quad (11)$$

where Q_{int} is the thermal energy of integration to the network produced at the central plant and $Q_{need,user}$ is the total thermal energy need of the buildings.

- Ground impact, which indicates the incidence of the soil in relation to the total heat requirement:

$$I_{ground} = \frac{Q_{ground}}{Q_{need,user}} [-] \quad (12)$$

where Q_{ground} is the energy exchanged between the network and the ground and $Q_{need,user}$ is the total thermal energy need of the buildings.

- Seasonal coefficients of performances, indicate the average COP and EER for users assessed throughout the year:

$$sCOP = \frac{\sum_i (COP_i \cdot E_{HP,el,i})}{\sum_i (E_{HP,el,i})} [-] \quad (13)$$

$$sEER = \frac{\sum_i (EER_i \cdot E_{HP,el,i})}{\sum_i (E_{HP,el,i})} [-] \quad (14)$$

where COP_i / EER_i and $E_{HP,el,i}$ are respectively the COP/EER value and the respective electrical demand of the WSHP at the i th hour. This index is evaluated for each user.

A second cluster of results reports the thermal grid dynamic performances, achieved analysing specific moments of the simulation period with an hourly detail of the results. Dynamic trends can be used for more exhaustive analyses on the behaviour of the network, for carrying out energy audits operations and for studying the model response in certain scenarios.

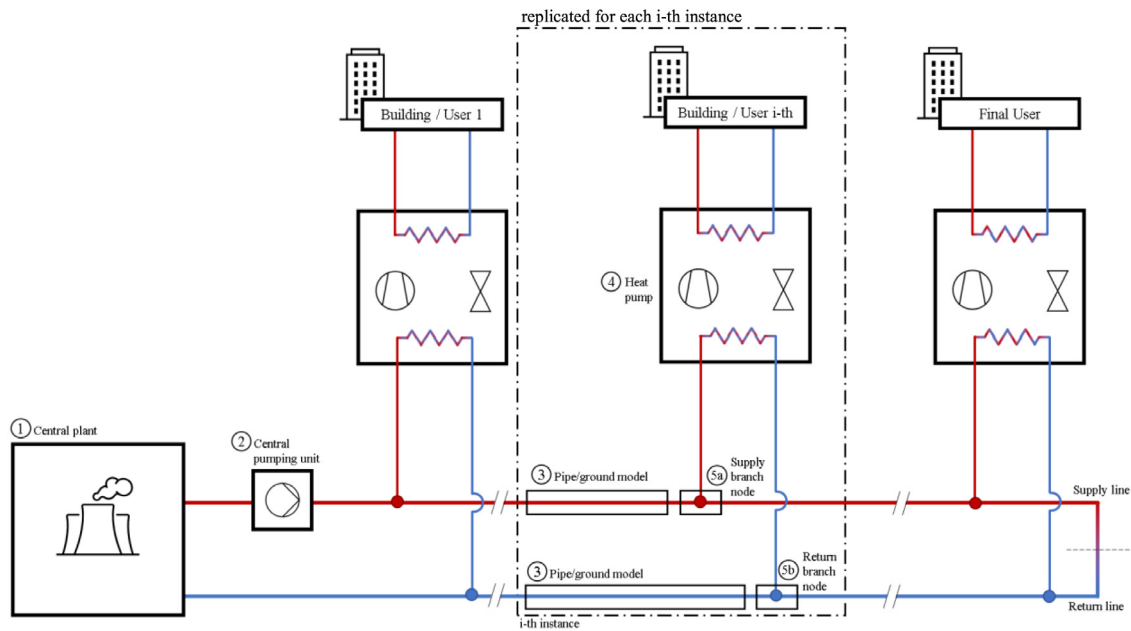

Fig. 10. 5GDHC network model scheme.

Table 3
Building users simulation scenario.

#	Category	Net conditioned area [m ²]	Heating		Cooling	
			Energy need [MWh/yr]	Power [kW]	Energy need [MWh/yr]	Power [kW]
1	Office	4844	2347	2035	3186	1188
2	Industry	2181	3105	1338	2395	881
3	Education	7145	1860	1624	2148	1478
4	Office	15101	3979	2416	4966	2921
5	Office	2568	1957	1583	2888	924
6	Office	2093	6361	1499	8248	460
7	Industry	16846	6361	9993	8013	5563
8	Industry	4008	4769	632	1769	1074
9	Industry	4277	5086	647	1881	1146
10	Public services	25861	1116	4662	1537	4100
11	Healthcare	3972	6175	1318	1456	2019

Table 4
Network key performance indicators.

Index	Description	Value
η_{th}	Network thermal efficiency	1.69
I_{el}	Electric index	0.19
I_{int}	External integration index	0.41
I_{ground}	Ground impact	0.007
sCOP	Global seasonal COP (users average)	4.06
sEER	Global seasonal EER (users average)	6.23

Table 5
U.S. average Source-Site Ratios for Electricity and Natural Gas 2012–2016 (U.S. Environmental Protection Agency, 2020).

Year	Source-site ratio (Electricity)	Source-site ratio (Natural gas)
2012	2.83	1.05
2013	2.82	1.05
2014	2.80	1.05
2015	2.76	1.04
2016	2.76	1.04

2.4. Simulation scenario

The model was developed to offer the maximum possible versatility. Users can be coupled and studied with unlimited

solutions, with the aim to get close to any real scenario. In fact, there are no limits on the quantity of users that can be integrated into the network, nor limits on the spatial distribution of the network, which can also be modelled to cover an entire city. The

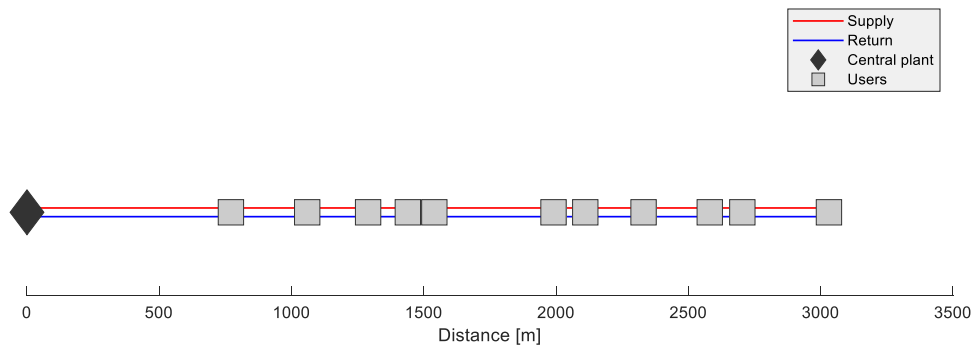

Fig. 11. Grid layout. (For interpretation of the references to colour in this figure legend, the reader is referred to the web version of this article.)

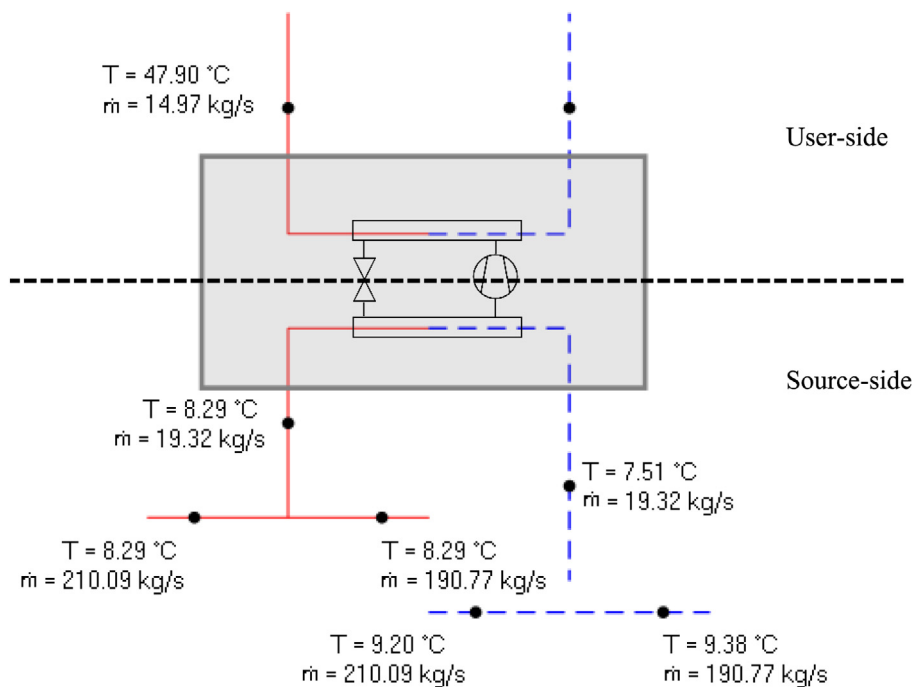

Fig. 12. Local analysis for user 5 substation at 12:00, 1st February. (For interpretation of the references to colour in this figure legend, the reader is referred to the web version of this article.)

work presented in this paper stands as a tool for analysis and focus on 5GDHC networks. The versatility of the model was tested in this paper by generating a simulation scenario able to describe the application of a 5GDHC to a potentially existing district. Eleven buildings belonging to different categories were selected, each one with proper energy needs. All the buildings considered exist and are located in the same USA city. For each facility, the energy consumption of heating and cooling were monitored for a whole year on an hourly basis. The monitoring data used to define the model inputs are part of the monitoring and analysis campaign “The Building Data Genome Project 2” (Miller et al., 2020), carried out by several research institutions. Data were mainly collected through the installation of energy meters inside the buildings. On the other hand, for the buildings with a facility management infrastructure, data were collected remotely. All raw data has been cleaned, organized and normalized before being made available, as reported (Miller and Meggers, 2017).

Starting from these data, a hypothetical district was generated, for a total extension of 3 km, consisting of 4 office users, 4 industrial users and 3 users belonging to other categories. Although the model was also able to simulate DHW production, the

simulation scenario adopted in this work focuses exclusively on heating and cooling needs. Using the monitoring data as input, the WSHP were sized, in terms of rated thermal power. In this way, each building has been associated with a suitable heat pump capable of satisfying its needs. The spatial distribution of the district has been hypothesized by placing the individual users at a variable distance between 100 m and 500 m, thus assuming they belong to the same district. As for the climatic data, they were collected hourly within the same monitoring campaign, and refer to the weather station of the chosen location. Table 3 summarizes the main data relating to the buildings considered in the simulation scenario, specifying the category, the net air-conditioned area, the annual heating and cooling energy need and the peak power recorded. Furthermore, Fig. A.1 in the appendix collects the hourly trends of the monitored energy data that have been used in this study.

Although limited to 11 buildings, this simulation scenario was identified to test the potential of the model, which is able to offer both a high level of detail in the design phase and a careful feasibility analysis on existing scenarios, such as the district just described. Additionally, adopting real monitoring data, it was

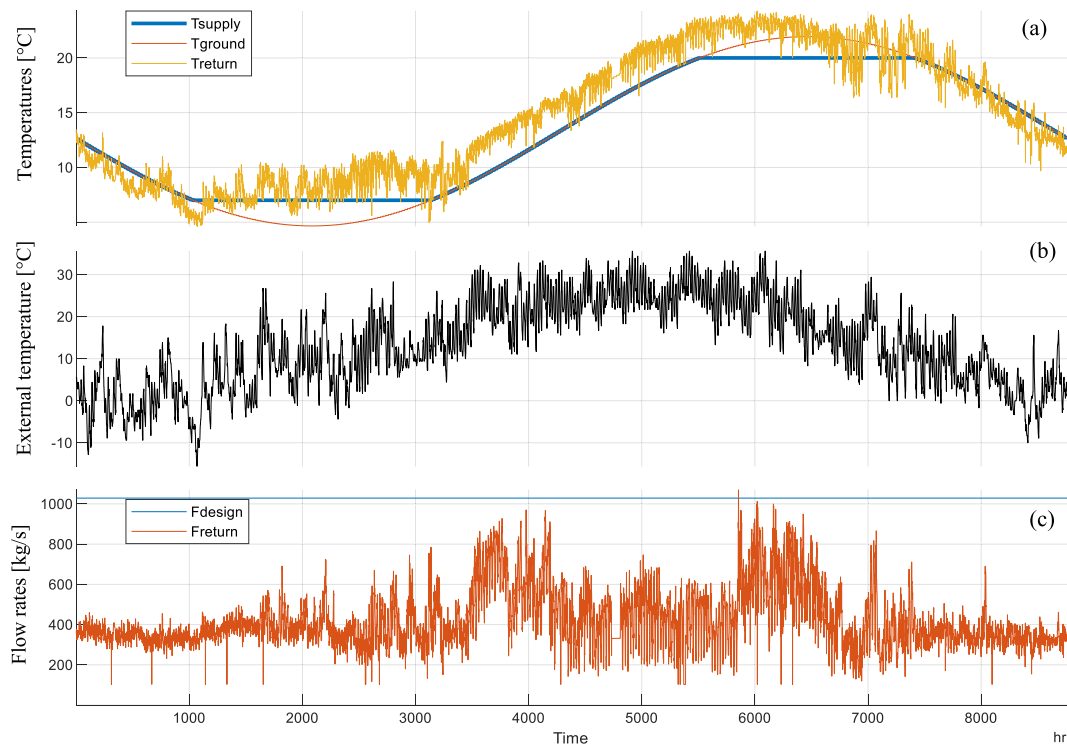

Fig. 13. Supply, return and ground temperature in the network (a), external temperature (b) design and return flow rate in the network (c). (For interpretation of the references to colour in this figure legend, the reader is referred to the web version of this article.)

possible to compare the actual energy consumption, based on autonomous generation solutions, with the new solution proposed within a 5GDHC network.

The regulation strategy adopted in this scenario was to keep the supply temperature to the users equal to that of the ground (at a depth of 2 m, where it was assumed to install the pipeline). This strategy allows to minimize the heat losses towards the ground, considering that the piping intended for this type of network is not insulated. The water supply temperature provided by the central plant is therefore variable during the year, following the ground temperature trend. However, in order not to incur too performance drops on the WSHP, the supply water temperature has been limited to the 7–20 °C range, reaching a compromise with the WSHP performance curves. To keep the supply temperature at the desired set-point, a central plant was simulated within the network. The energy spent in the central plant was defined as integration energy (Q_{int}).

3. Results and discussion

By solving the mass and energy balance equations in each node of the system, the model is able to describe the behaviour of the network and substations. The model nodes are represented by all the users and the central plant. The results presented in this section describe the temperature, flowrates and energy exchange trends for each node of the model with an hourly simulation detail. Through the pre-processing phase, the configuration of the network was established and shown in Fig. 11, where the reciprocal position between the various nodes of the model can be identified, represented by the distance (in m) on the x axis of the graph. The 0 m position is occupied by the central plant (black diamond), while the users (grey squares) are arranged along the supply (red) and return (blue) pipeline.

The detail of a substation is shown in Fig. 12. The figure shows the substation (user) 5, during its operation at 12:00 on 1st February. The local results of the heat transfer fluid flows

have been reported both for the user (user-side, above) and for the network (source-side, below). For each node of the substation the model is able to simulate temperatures and flowrates. In this work, a user-side ΔT equal to 5 °C was set, with a temperature control on the user-side supply temperature, that is controlled by a climatic curve. From the source-side, on the other hand, it is possible to identify the points of energy exchange between the substation and the general network double-pipeline, both for supply (red) and return (blue).

A dynamic hourly result that allows to view the general operation of the network during the simulation year is shown in Fig. 13. Fig. 13a shows the supply water temperature, the return water temperature and the ground temperature for each hour of the simulation. The undisturbed ground temperature (orange line) was assessed from the weather data used. The supply (blue line) and return (yellow line) water temperatures are evaluated as the temperature leaving and returning to the central plant node, respectively. The supply temperature follows the trend of that of the ground in the 7–20 °C temperature range: in this temperature interval supply and ground temperatures coincide. This result is the consequence of the regulation strategy adopted on the network supply temperature, aiming at minimizing the ground losses. During the summer season, it was decided to keep the supply temperature at a maximum value of 20 °C although the ground temperature was higher, in order to maintain high performance of the WSHP, operating mostly for cooling purposes. On the contrary, during winter season a minimum supply set point of 7 °C was set as part of the same control strategy. Another interesting result is represented by the return temperature to the central plant. From the results obtained, the return temperature is higher than the delivery temperature for most of the hours of the year, indicating a prevalence of the behaviour of the network in cooling mode. This behaviour is mainly due to the coupling of the users, mostly industrial, with high cooling need even during the coldest months. However, during the months of January and December the network has a prevalent heating behaviour causing

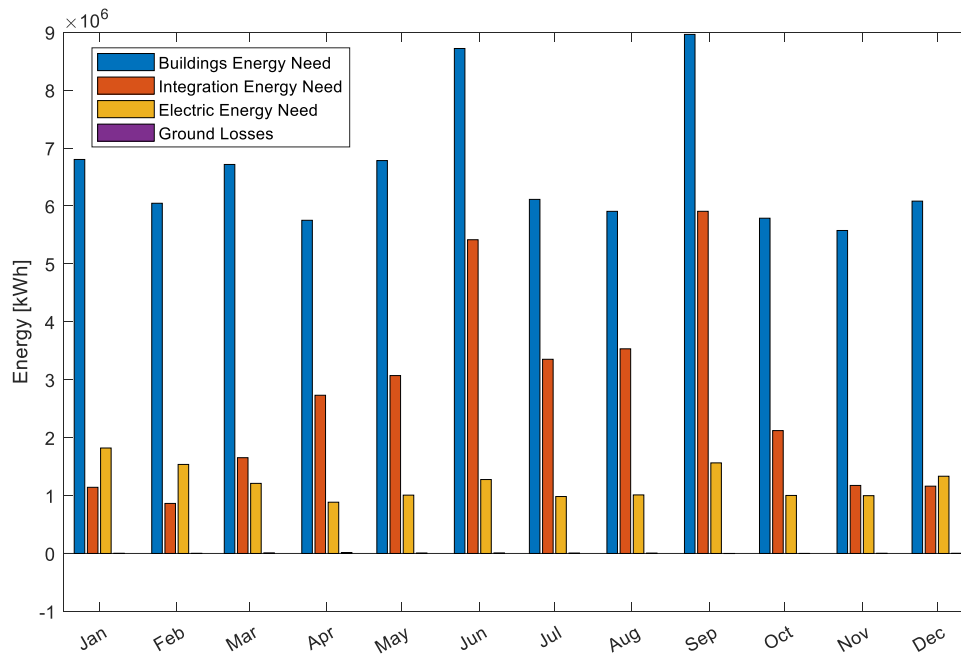

Fig. 14. Grid monthly energy balance results. (For interpretation of the references to colour in this figure legend, the reader is referred to the web version of this article.)

a lowering of the return temperature. From the same graph it is evident the supply temperature control strategy, which differs from that of the ground outside the range 7–20° C, during the months February–March and September.

Fig. 13c shows the trend of the water flowrate within the network during the simulation year, flowing across the central plant. The design flowrate (blue line) was sized during the pre-processing of the model, analysing the profiles of the energy needs of the buildings, and is shown in the figure as a reference value. The actual simulation trend of the flowrate that circulates within the network is represented by the return flow (orange line), which also coincides with the supply flow. From the trend in the figure, it can be seen that the network requires higher flowrate in the summer season, which coincides with the higher energy needs of the buildings. However, the winter season has a steady trend in its energy demand and is more predictable in terms of network response. The flowrate circulating in the network never drops below the minimum value of 102.8 kg/s, equivalent to 10% of the design flow rate. This design value was set as a fixed parameter even when there is no energy request from the network to ensure a background flowrate in the network, avoiding processes of switching off and starting the pumps and systems in the central plant.

The overall behaviour of the network was assessed using the performance indexes presented in the previous section. The results obtained from the simulated scenario are reported in Table 4. The thermal efficiency of the network (η_{th}) has reached a value of 1.69, indicating that it is necessary to spend one kWh of energy to supply 1.69 kWh of thermal energy to the users. This index does not distinguish the form of energy spent, which can be either electric, spent through the use of WSHP, or thermal, spent through the integration heat provided by the central plant. More detailed performance indexes are represented by the electric index (I_{el}) and the external integration index (I_{int}). They respectively represented the percentage value of electricity and integration energy spent with respect to the total energy needs of the buildings in the network. From the simulation results, it

can be stated that the electrical energy spent weighs 19% of the energy required by buildings, while the integration heat has a weight of 41%. The energy loss towards the ground was also assessed using the ground index (I_{ground}), and weights 0.7% of the energy required by the buildings. This very limited value is a consequence of the choice adopted for the regulation of the supply temperature, set as equal to the ground temperature.

Finally, the classic WSHP seasonal COP and EER were also evaluated. The values shown in the table refer to the entire heating and cooling season and have been reported as average values for all connected users.

The total energy amount for the entire network, used in the evaluation of the performance indexes just described, is reported in Fig. 14. The values in the figure allow to characterize the size of the network, evaluating the month-by-month performances. The energy needs of the buildings (blue bars), given by the overall heating and cooling need, are fairly constant during the year, with a slight increase in the months of June and September. A similar trend is also reported by the integration energy required in the central plant (orange bars). Regarding the electrical need of the network (yellow bars) the monthly trend is different, presenting higher values in the winter months. This result specifically reflects the performance maps of the heat pumps adopted which, with the same thermal load, are more efficient in summer operation. The graph also shows the losses (positive) or gains (negative) of the network (purple bars) with respect to the ground. However, the interaction with the ground is hardly visible from the graph since the network control strategy aimed to minimize losses to the ground.

To conclude the analysis of the results obtained from the model developed in this work, a benchmark was carried out between the 5GDHC network and a more traditional alternative case, where the thermal needs of the buildings connected to the network were satisfied by coupling a natural gas boiler for space heating and DHW and a chiller for space cooling. The benchmark between the two proposed alternatives was carried out in terms of primary energy, limiting the analysis boundary to users only.

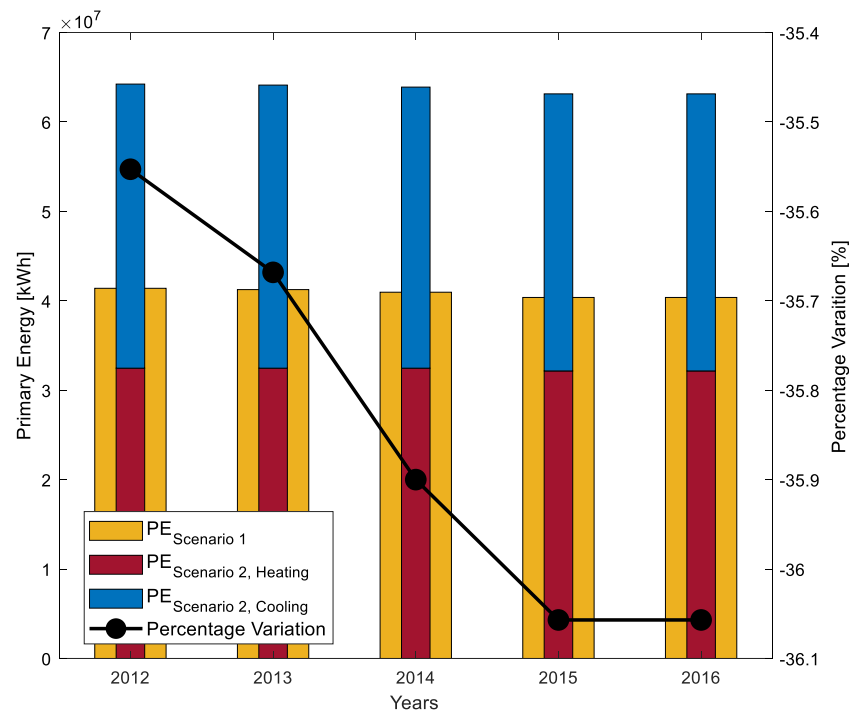

Fig. 15. Primary energy comparison for the evaluated scenarios.

In the innovative scenario, in which the needs were completely satisfied by the 5GDHC network, the only energy vector taken into consideration was the electricity to power the WSHP. On the contrary, in the traditional scenario consisting of a gas boiler and chiller, the energy carriers of both electricity and natural gas have been taken into consideration. Furthermore, the efficiencies of the technical systems considered in the traditional scenario were evaluated with the following approximations:

- the efficiency of the gas boilers was considered constant, with an efficiency of 0.90;
- the energy efficiency ratio (EER) of the chillers was dynamically evaluated on an hourly basis, considering air-cooled condensers.

After defining the values of final energy consumed in both scenarios, site energy source factors were applied to analyse the energy needs in terms of primary energy. Average conversion factors for the United States were applied, considering their trend in the years 2012–2016 (U.S. Environmental Protection Agency, 2020). The values used for the analysis are reported in Table 5.

The trend of the results for the years taken into consideration is shown in Fig. 15, in terms of primary energy (bar plot) and percentage variation between the two scenarios (black line). The results show the benefit of the 5GDHC network (Scenario 1), compared to a traditional solution without a thermal network. The reduction of the primary energy need is greater than 35% with respect to the traditional scenario. The analysis was conducted using primary energy factors that vary over time, with reference to the years 2012–2016. The temporal trend is in fact considered as a relevant parameter. The percentage variation of primary energy between the 5GDHC scenario and the traditional scenario increases over the years. This result, considering the electrification of the 5GDHC network, will tend to generate results with greater benefits over the years compared to a traditional solution (Arjunan et al., 2020).

4. Conclusions

In this work a new model of 5GDHC network has been tested. Although numerous research studies have focused on this topic in recent years, the application of this new generation of district heating and cooling networks remains limited to a few case studies and pilot projects, often funded by European research funds. The economic interest in developing this type of thermal network is still quite restricted, due to limited and weak tools for assessing the energy performance of these infrastructures. For this reason, in this paper a numerical model was developed, with the aim of simulating the energy behaviour of a 5GDHC network, starting from the definition of the annual energy demand profiles of the users connected to the network. The model described in this work is able to produce a preliminary assessment for the sizing of the network and is able to evaluate the general performance of the network by means of some global performance indexes evaluated on the results of an annual simulation. Furthermore, the model allows to analyse in detail the hourly dynamic behaviour of the main nodes of the network, where mass and energy transfer takes place. This model therefore represents a first tool to support the design and adoption of this type of thermal network, providing a preliminary performance evaluation.

In this work, a hypothetical simulation scenario was taken into consideration, consisting of 11 real users with different energy needs, with an annual energy need of about 79.2 GWh. The users, each represented by a building, were coupled within a 5GDHC and simulated for an annual period. The results obtained have shown that the coupling of users within the network can lead to interesting results in terms of rational use of energy. The thermal efficiency of the network, assessed by means of a specifically defined index, is equal to 1.69, while the percentage weight of the electric need and thermal integration are 19% and 41% respectively.

The work proposed in this paper has demonstrated significant potential for both applications and future developments of

5GDHC. Future works will consider a higher number of simulation scenarios, made up of users defined according to specific criteria. A model validation process is also of particular interest for the future developments of this work, while being ambitious in terms of creating a possible monitored infrastructure.

CRediT authorship contribution statement

Matteo Bilardo: Acquisition of data, Analysis and/or interpretation of data, Drafting the manuscript. **Federico Sandrone:** Conception and design of study. **Guido Zanzottera:** Conception and design of study. **Enrico Fabrizio:** Analysis and/or interpretation of data, Revising the manuscript critically for important intellectual content.

Declaration of competing interest

The authors declare that they have no known competing financial interests or personal relationships that could have appeared to influence the work reported in this paper.

Acknowledgement

All authors approved the version of the manuscript to be published.

Appendix

See Fig. A.1.

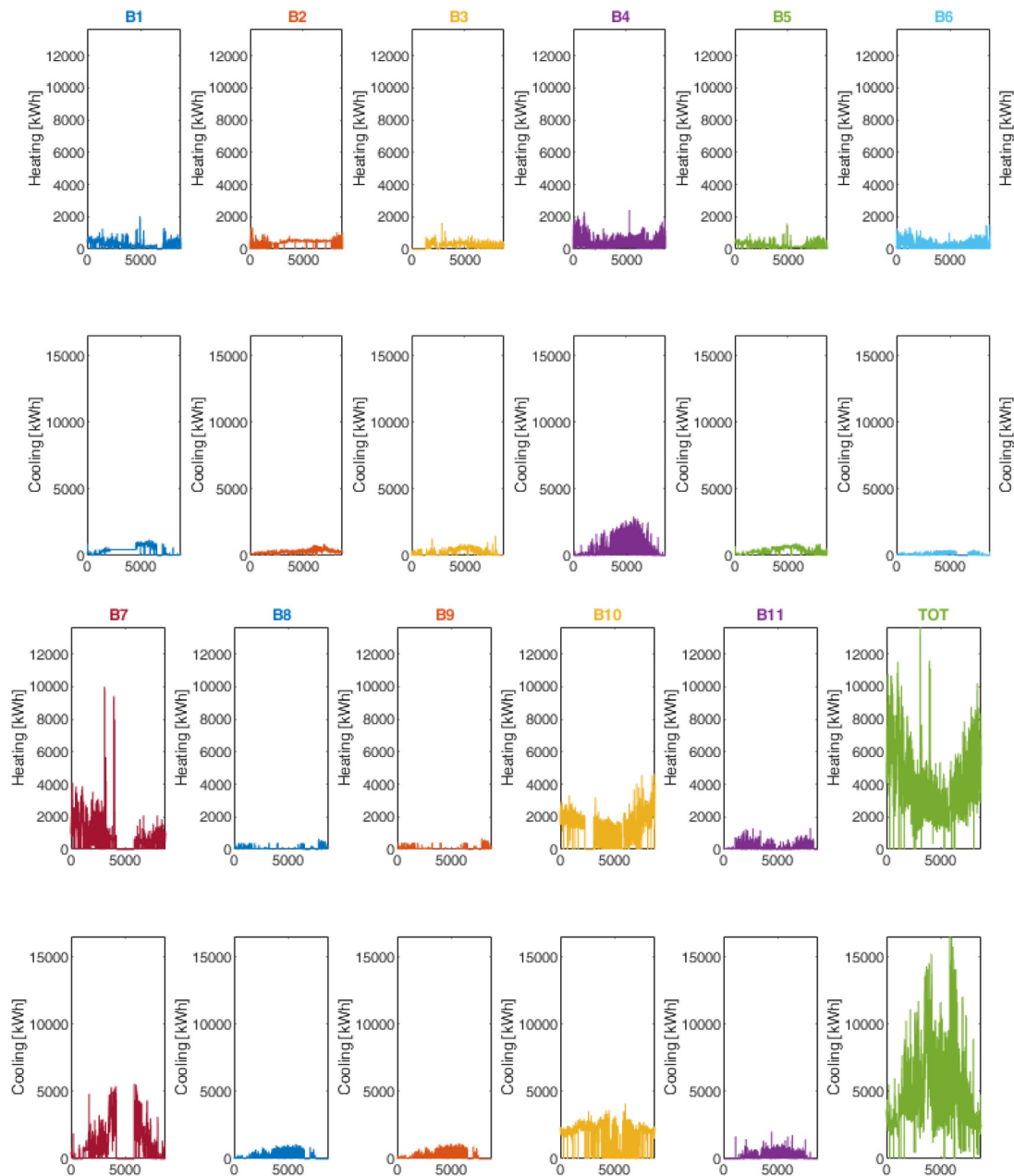

Fig. A.1. Building energy need for heating and cooling for the simulated scenario.

References

- Arabkoohsar, A., Alsagri, A.S., 2020. A new generation of district heating system with neighborhood-scale heat pumps and advanced pipes, a solution for future renewable-based energy systems. *Energy* 193. <http://dx.doi.org/10.1016/j.energy.2019.116781>.
- Arjunan, P., Poolla, K., Miller, C., 2020. Energystar++: Towards more accurate and explanatory building energy benchmarking. *Appl Energy* 276. <http://dx.doi.org/10.1016/j.apenergy.2020.115413>.
- ASHRAE, 2019. *ASHRAE Handbook - HVAC Applications*, SI ed.
- Bauwens, T., Gotchev, B., Holstenkamp, L., 2016. What drives the development of community energy in Europe? the case of wind power cooperatives. *Energy Res Soc Sci* 13, 136–147. <http://dx.doi.org/10.1016/j.erss.2015.12.016>.
- Buffa, S., Cozzini, M., D'Antoni, M., Baratieri, M., Fedrizzi, R., 2019. 5th generation district heating and cooling systems: A review of existing cases in europe. *Renew Sustain Energy Rev* 104, 504–522.
- Bünning, F., Wetter, M., Fuchs, M., Müller, D., 2018. Bidirectional low temperature district energy systems with agent-based control: Performance comparison and operation optimization. *Appl Energy* 502–515. <http://dx.doi.org/10.1016/j.apenergy.2017.10.072>.
- Buonomano, A., Calise, F., Palombo, A., 2012. Buildings dynamic simulation: Water loop heat pump systems analysis for European climates. *Appl Energy* 91, 222–234. <http://dx.doi.org/10.1016/j.apenergy.2011.09.031>.
- Calixto, S., Cozzini, M., Manzolini, G., 2021. Modelling of an existing neutral temperature district heating network: Detailed and approximate approaches. *Energies* 14, 379. <http://dx.doi.org/10.3390/en14020379>.
- Chmutina, K., Goodier, C.I., 2014. Alternative future energy pathways: Assessment of the potential of innovative decentralised energy systems in the UK. *Energy Policy* 66, 62–72. <http://dx.doi.org/10.1016/j.enpol.2013.10.080>.
- Coccia, G., D'Agaro, P., Cortella, G., Polonara, F., Arteconi, A., 2019. Demand side management analysis of a supermarket integrated HVAC, refrigeration and water loop heat pump system. *Appl Therm Eng* 152, 543–550. <http://dx.doi.org/10.1016/j.applthermaleng.2019.02.101>.
- Connolly, D., Lund, H., Mathiesen, B.V., Werner, S., Möller, B., Persson, U., Boermans, T., Trier, D., Østergaard, P.A., Nielsen, S., 2014. Heat roadmap europe: Combining district heating with heat savings to decarbonise the EU energy system. *Energy Policy* 65, 475–489. <http://dx.doi.org/10.1016/j.enpol.2013.10.035>.
- Department of Energy & Climate Change, 2016. *DECC heat pumps in district heating: final report case studies*.
- European Commission, 2012a. European commission directive 2012/27/EU of the European parliament and of the council of 25 2012 on energy efficiency, amending directives 2009/125/EC and 2010/30/EU and repealing directives 2004/8/EC and 2006/32/EC. *Off J Eur Union* 1–56. http://dx.doi.org/10.3000/19770677.L_2012.315.eng.
- European Commission, 2012b. European commission energy roadmap 2050. Policy 1–9. <http://dx.doi.org/10.2833/10759>.
- European Union, 2018. European commission directive 2018/844/EU of the European parliament on the energy performance of building. *Off J Eur Union*.
- EUROSTAT, 2020. Eurostat Energy statistics - an overview - Statistics Explained Available online: https://ec.europa.eu/eurostat/statistics-explained/index.php?title=Energy_statistics_-_an_overview#Final_energy_consumption (accessed on Mar 23, 2020).
- Fernández, F.J., Folgueras, M.B., Suárez, I., 2017. Energy study in water loop heat pump systems for office buildings in the Iberian Peninsula. In: *Proceedings of the energy procedia*. vol. 136, 2017, p. 91–6.
- del Hoyo Arce, I., Herrero López, S., López Perez, S., Rämä, M., Klobut, K., Febres, J.A., 2018. Models for fast modelling of district heating and cooling networks. *Renew Sustain Energy Rev* 82, 1863–1873.
- International Energy Agency, 2016. *IEA energy and CO2 emissions in the OECD*.
- Leviñh, F., 2017. CHP and heat pumps to balance renewable power production: Lessons from the district heating network in stockholm. *Energy* 137, 670–678. <http://dx.doi.org/10.1016/j.energy.2017.01.118>.
- Lowitzsch, J., Hoicka, C.E., van Tulder, F.J., 2020. Renewable energy communities under the 2019 European Clean Energy Package – Governance model for the energy clusters of the future? *Renew Sustain Energy Rev* 122, 109489. <http://dx.doi.org/10.1016/j.rser.2019.109489>.
- Lund, H., Duic, N., Østergaard, P.A., Mathiesen, B.V., 2018a. Future district heating systems and technologies: On the role of smart energy systems and 4th generation district heating. *Energy* 165, 614–619. <http://dx.doi.org/10.1016/j.energy.2018.09.115>.
- Lund, H., Østergaard, P.A., Chang, M., Werner, S., Svendsen, S., Sorknæs, P., Thorsen, J.E., Hvelplund, F., Mortensen, B.O.G., Mathiesen, B.V., et al., 2018b. The status of 4th generation district heating: Research and results. *Energy* 164, 147–159. <http://dx.doi.org/10.1016/j.energy.2018.08.206>.
- Lund, H., Werner, S., Wiltshire, R., Svendsen, S., Thorsen, J.E., Hvelplund, F., Mathiesen, B.V., 2014. 4th generation district heating (4GDH). Integrating smart thermal grids into future sustainable energy systems. *Energy* 68, 1–11.
- Mazhar, A.R., Liu, S., Shukla, A., 2018. A state of art review on the district heating systems. *Renew Sustain Energy Rev* 96, 420–439.
- Miller, C., Kathirgamanathan, A., Picchetti, B., Arjunan, P., Park, J.Y., Nagy, Z., Raftery, P., Hobson, B.W., Shi, Z., Meggers, F., 2020. The building data genome project 2, energy meter data from the ASHRAE great energy predictor III competition. *Sci Data* 7. <http://dx.doi.org/10.1038/s41597-020-00712-x>.
- Miller, C., Meggers, F., 2017. The building data genome project: An open, public data set from non-residential building electrical meters. In: *Proceedings of the energy procedia*. vol. 122. Elsevier Ltd, pp. 439–444.
- Mitsubishi S.p.A., 2016. Mitsubishi Electric Hydronics & IT Cooling Systems S.p.A. Tigné Point Project Available online: <https://www.melcohit.com/EN/Projects/3840/tigne-point.html> (accessed on Mar 26, 2020).
- Paiho, S., Reda, F., 2016. Towards next generation district heating in Finland. *Renew Sustain Energy Rev* 65, 915–924.
- Pizzolato, A., Sciacovelli, A., Verda, V., 2018. Topology optimization of robust district heating networks. *J Energy Resour Technol Trans ASME* 140. <http://dx.doi.org/10.1115/1.4038312>.
- REN21, 2018. *Renewables 2018: Global Status Report*.
- Revesz, A., Jones, P., Dunham, C., Davies, G., Marques, C., Matabuena, R., Scott, J., Maidment, G., 2020. Developing novel 5th generation district energy networks. *Energy* 201, 117389. <http://dx.doi.org/10.1016/j.energy.2020.117389>.
- Rezaie, B., Rosen, M.A., 2012. District heating and cooling: Review of technology and potential enhancements. *Appl Energy* 93, 2–10. <http://dx.doi.org/10.1016/j.apenergy.2011.04.020>.
- von Rhein, J., Henze, G.P., Long, N., Fu, Y., 2019. Development of a topology analysis tool for fifth-generation district heating and cooling networks. *Energy Convers Manag* 196, 705–716. <http://dx.doi.org/10.1016/j.enconman.2019.05.066>.
- Sommer, T., Sulzer, M., Wetter, M., Sotnikov, A., Mennel, S., Stettler, C., 2020. Journal pre-proof the reservoir network: A new network topology for district heating and cooling. *Energy* 117418. <http://dx.doi.org/10.1016/j.energy.2020.117418>.
- Talebi, B., Mirzaei, P.A., Bastani, A., Haghghat, F., 2016. A review of district heating systems: Modeling and optimization. *Front Built Environ* 2. <http://dx.doi.org/10.3389/fbuil.2016.00022>.
- Testi, D., Urbanucci, L., Giola, C., Schito, E., Conti, P., 2020. Stochastic optimal integration of decentralized heat pumps in a smart thermal and electric micro-grid. *Energy Convers Manag* 112734. <http://dx.doi.org/10.1016/j.enconman.2020.112734>.
- United Nations, D. of E. and S. A., 2018. *World Urbanization Prospects: The 2018 Revision*.
- U.S. Environmental Protection Agency, 2020. *ENERGY STAR Portfolio Manager - Source Energy - Technical Reference*.
- Wirtz, M., Kivilip, L., Remmen, P., Müller, D., 2020. 5th generation district heating: A novel design approach based on mathematical optimization. *Appl Energy* 260. <http://dx.doi.org/10.1016/j.apenergy.2019.114158>.
- Zajacs, A., Bogdanovics, R., Borodinecs, A., 2020. Analysis of low temperature lift heat pump application in a district heating system for flue gas condenser efficiency improvement. *Sustain Cities Soc* 57. <http://dx.doi.org/10.1016/j.scs.2020.102130>.
- Zhang, Y., Campana, P.E., Yang, Y., Stridh, B., Lundblad, A., Yan, J., 2018. Energy flexibility from the consumer: Integrating local electricity and heat supplies in a building. *Appl Energy* <http://dx.doi.org/10.1016/j.apenergy.2018.04.041>.