

Electromagnetic Interference of Spread-Spectrum Modulated Power Converters in G3-PLC Power Line Communication Systems

Original

Electromagnetic Interference of Spread-Spectrum Modulated Power Converters in G3-PLC Power Line Communication Systems / El Sayed, W., Crovetto, P.S., Moonen, N., Lezynski, P., Smolenski, R., Leferink, F.. - In: IEEE LETTERS ON ELECTROMAGNETIC COMPATIBILITY PRACTICE AND APPLICATIONS. - ISSN 2637-6423. - STAMPA. - 3:4(2021), pp. 118-122. [10.1109/LEMCPA.2021.3121091]

Availability:

This version is available at: 11583/2934092 since: 2021-10-23T10:10:40Z

Publisher:

IEEE

Published

DOI:10.1109/LEMCPA.2021.3121091

Terms of use:

This article is made available under terms and conditions as specified in the corresponding bibliographic description in the repository

Publisher copyright

IEEE postprint/Author's Accepted Manuscript

©2021 IEEE. Personal use of this material is permitted. Permission from IEEE must be obtained for all other uses, in any current or future media, including reprinting/republishing this material for advertising or promotional purposes, creating new collecting works, for resale or lists, or reuse of any copyrighted component of this work in other works.

(Article begins on next page)

Electromagnetic Interference of Spread-Spectrum Modulated Power Converters in G3-PLC Power Line Communication Systems

Waseem El Sayed, *Student Member, IEEE*, Paolo Crovetto, *Senior Member, IEEE*, Niek Moonen, *Member, IEEE*, Piotr Lezynski, *Senior Member, IEEE*, Robert Smolenski, *Member, IEEE* and Frank Leferink, *Member, IEEE*

Abstract— The impact of spread-spectrum techniques used to mitigate EMI from power converters on Power Line Communication (PLC) systems is studied in this paper. A buck converter, utilizing a Random Carrier Frequency Modulation with Fixed Duty cycle (RCFMFD) based control is considered as a source of conducted EMI and a narrowband G3-PLC as the victim. It is shown that, although considered to be an EMI mitigating technique, the spread spectrum technique has a detrimental effect on the communication channel, which can be explained in the framework of Shannon's information theory. Conventional emission evaluation methods are therefore incompatible with modern day's technology.

Keywords—Power Line Communication (PLC) - Electromagnetic Compatibility (EMC) - Random Carrier Frequency Modulation Fixed Duty (RCFMFD)

I. INTRODUCTION

Nowadays, reliable communication between the smart grid elements is a very important issue for the system's operation. However, the communication network may be susceptible to Electromagnetic Interference (EMI) generated in the complex smart grid environment due to the increased utilization of power converters. Consequently, a higher number of converters will increase the total EMI level, and thus the probability of the accumulated noise exceeding levels that devices can withstand is increasing. The presence of the power semiconductor devices in loads such as lamps, chargers, and any other nonlinear devices are the leading cause of the increase in conducted emissions [1]. On the other hand, the increased complexity of the system requires an increase in communication between smart grid elements to assure reliable system operation.

This paper is part of a project that has received funding from the European Union's Horizon 2020 research and innovation program under the Marie Skłodowska-Curie grant agreement No 812391 – SCENT.

Waseem El Sayed, Piotr Lezynski, and Robert Smolenski are all in the Institute of Automatic Control Electronics and Electrical Engineering University of Zielona Gora, Zielona Gora, Poland (E-mails: p.lezynski@iee.uz.zgora.pl and r.smolenski@iee.uz.zgora.pl).

Paolo Crovetto, Department of Electronics and Telecommunications Torino, Politecnico di Torino, Torino, Italy. (E-mail: paolo.crovetto@polito.it).

Waseem El Sayed, Niek Moonen and Frank Leferink are all in Electrical Engineering, Mathematics & Computer Science (EEMCS), University of Twente, Enschede, Netherlands. (E-mail: w.wafiksaadelsayed@utwente.nl, niek.moonen@utwente.nl and frank.leferink@utwente.nl).

Waseem El Sayed, George Green Institute for Electromagnetics Research, University of Nottingham, Nottingham NG7 2RD, United Kingdom

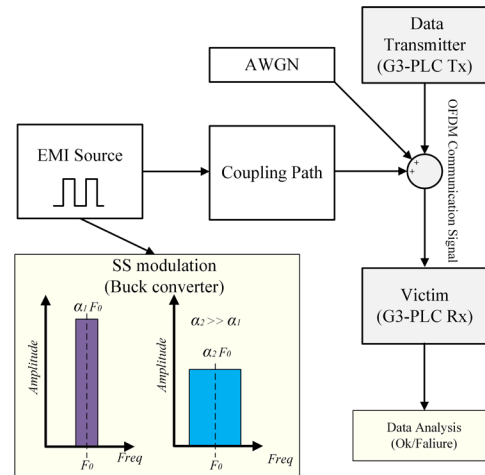

Fig. 1. Block diagram represents the SS modulation EMI with the PLC

Consequently, the communication network may be affected due to parasitic coupling with an EMI source[2], [3].

The Power Line Communication (PLC) is a very important communication network in smart grid systems, especially in smart meter home applications, as it uses the existing infrastructure for data transmission and can be affected by conducted EMI generated in the system [4]–[6]. Most of the smart meters in the smart grid operate in the narrowband range of CISPR A standard (from 9 kHz to 150 kHz).

Typical sources of EMI are power converters that utilize a fundamental switching frequency laying in the same frequency range of CISPR A. Their impact on the PLC can be quantified via the reduction in throughput, thus the transmission error rate occurring will give an in-situ performance assessment as shown in Fig.1. Hence, Spread-Spectrum (SS) techniques are used to mitigate EMI generated by the power converters at a low cost and without requiring additional hardware [7]–[9]. Randomized

Take-Home Messages:

- A buck converter interfering with a G3-PLC system is considered
- When spread-spectrum modulations are applied in the power converter, the measured frame error rate in the PLC system is found to be worse than without modulations.
- The results are consistent with the EMI-induced capacity loss expected from theory.
- While effective to comply with EMC standards, spread-spectrum modulations are not always a good way to mitigate EMI.

Pulse Width Modulation (PWM) techniques generate the wanted output voltage from the converters with the variable switching frequency, as opposed to using a single one. This provides a decreased EMI power spectrum measured according to standard electromagnetic emission test procedures (e.g. CISPR 14-1).

Three recent papers, and one from 2016, in which four of the authors of this paper participated addressed the effects of the randomized techniques in the communication systems.[2], [10]–[13]. The results in the previous papers have shown that the SS modulated EMI could provide better or equal performance to the uncoded communication systems [10]–[13], however, in the case of the coded communication systems, the performance of the SS modulated EMI has a different effect [2]. In this paper, the effect of the Random Carrier Frequency Modulation Fixed Duty (RCFMFD) based control is studied. It is applied to a buck converter while assessing its effect on the G3-PLC performance under different operating scenarios. The theoretical background of the traditional EMI evaluation is introduced in Section II. Section III describes the proposed experimental setup and the results are introduced in Section IV. The results will be then discussed in the framework of Shannon’s information theory and compared with the channel capacity loss which is brought by spread-spectrum EMI in digital communication channels, as discussed in [3]–[4], [16] is presented in Section V. Finally, the conclusion of the work is given in Section VI.

II. TRADITIONAL EMI EVALUATION

In general, the EMI is evaluated based on the EMC standards measuring the amplitude spectrum in the applicable frequency range. The allocated narrowband PLC bandwidth is in the range between 3 to 150 kHz, following the CENELEC European standard, EN 50065-1. However, there is an overlap between the EN50065 standard designed for the transmitters of the PLC equipment and other standards such as CISPR 15 (EN55015) and CISPR 11 (EN 55011) [14] [15]. Moreover, the limits of these standards exceed the maximum limits of the non-intention EMI stated on the EN 50065-1 standard.

The most commonly used protocols in the narrowband PLC are the G3-PLC and the PRIME [16], [17]. Like any type of communication technology, the PLC system consists of three main parts: the transmitter, the channel, and the receiver. The transmitter combines Differential Phase Shift Keying (DPSK) and Orthogonal Frequency Division Multiplexing (OFDM) to transmit the data [18]. In this research we consider using the G3-PLC technology, the G3-PLC technology work with the Physical Layer (PHY) specifications defined in [13]. It has been shown in [16] and [17] that data transmission errors occur most likely at the center of the PLC band, which is where the impedance is the lowest.

During transmission, the data can be affected by several types of noises, e.g. additive white gaussian background noise (AWGN) and periodical impulsive noise [19]. The periodic impulsive noise could be due to the high switching frequency of spread spectrum modulation, especially in the CISPR A standard range which could overlap with CENELEC one.

The basic concept of spread-spectrum techniques is to distribute the power of a signal over a frequency band instead

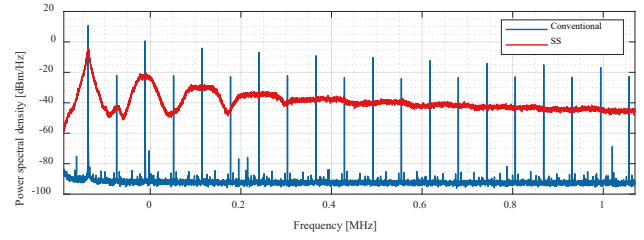

Fig. 2. PWM representation in the frequency domain in case of a) conventional modulation and b) PAM SS modulation with $\alpha = 0.25$.

of concentrating it in a specific fixed frequency as shown in Fig.2 This can be accomplished by applying a uniform random distribution source on the PWM signal parameters. Based on [20], spread-spectrum modulation techniques can be divided into four main types: Random Pulse Width Modulation (RPWM), Randomized Pulse Position Modulation (RPPM), Random Carrier Frequency Modulation Fixed Duty (RCFMFD), and Random Carrier Frequency Modulation Variable Duty (RCFMVD). In this paper, we focus on using the RCFMFD as a randomized technique for our test setup, at which the frequency changes around the main switching frequency rapidly by a definite rate with time. The RCFMFD follows these equations

$$f_{\text{PWM}} = f_0 + \Delta f \times \varepsilon(\tau) \quad (1)$$

$$\Delta f = f_0 \times \alpha, \quad \alpha: 0.05 \text{ to } 0.27 \quad (2)$$

where f_0 is the central frequency of the spread modulation signal, f_{PWM} is the output frequency of the spread signal, α represents the spreading factor of the signal and $\varepsilon(\tau)$ is the driving signal for the frequency change. The function of the driving signal $\varepsilon(\tau)$ could be sinusoidal, triangular, or a random Pulse Amplitude Modulated (PAM) signal [9]. Considering the driving signal $\varepsilon(\tau)$ as a random PAM signal, the $\varepsilon(\tau)$ can be expressed as:

$$\varepsilon(\tau) = \sum_k \delta_k g(t - kT) \quad (3)$$

where δ_k is a uniformly distributed pseudorandom number varying between -0.5 and +0.5, $g(t - kT)$ is a rectangular function with duration time T and k represents the number of samples in time.

III. THE PROPOSED EXPERIMENTAL SETUP

In this section, the experimental testbed is presented. The experimental setup consists of two main circuits: the communication circuit and the power converter circuit. Both circuits are coupled together by means of mutual coupling between the communication cable and the power cable as shown in Fig. 3.

A. PLC Circuit

Two PL360 PLC modems from Microchip are used to perform the point-to-point communication. The modems are programmed to operate using the G3-PLC standard. Between the mains connection and PLC system, the Line Stabilization Impedance Network (LISN) is used to provide a well-defined termination impedance to the cable and also to suppress

additional EMI from the power grid. An overview of the PLC test parameters is given in Table. I. In this circuit, we didn't consider any AC loads in order to study the influence of the modulation techniques separately without any other parameters that could affect the results.

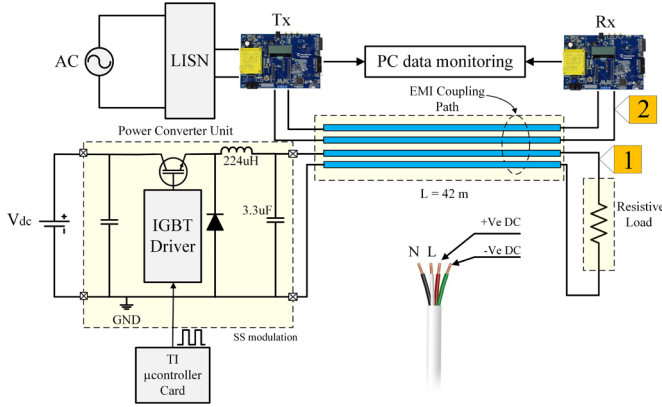

Fig.3. PLC system connection diagram

TABLE I. PLC TEST ASSUMPTIONS

Type of PLC communication standard	G3-PLC
Data size	65 bytes
Physical layer	OFDM
Modulation	DBPSK
The nominal bitrate	0 to 33.4 kbit/Sec
Total sent packets	2000
The time between each packet	500 ms
The medium	Single-phase cable of length 42 m

B. Power Converter Circuit

The power converter considered in the experiment is a switched-mode buck converter operating with one IGBT transistor with a maximum operational power of 1800 W and with a maximum input voltage of 450V. Moreover, a lowpass LC filter was implemented with a cut-off frequency of 5.8 kHz to enhance the output voltage and current. A Texas Instruments TMS320f28335 DSP card is used to apply the RCFMFD modulation. The duty cycle is fixed to 50 % and the switching frequency is spread around a central frequency of 63 kHz, which coincides with the intermediate frequency of the PLC bandwidth. The used supply voltage is 150 V and a sliding resistor is adjusted so the maximum current drawn is 1.25 A. The positive output cable is placed close (in a bundled cable) to the PLC circuit to ensure coupling between the systems.

IV. PLC EXPERIMENTAL RESULTS

All the results were taken using Gauss Instrument EMI receiver, the average detector (AV) was used in the frequency spectrum measurement with Intermediate Band Width (IFBW) of 200Hz, following the CISPR A standard. The RCFMFD equations are implemented in the MATLAB Simulink using a uniform random number generator and several additions and multiplications. The uniform random numbers are generated between -0.5 to 0.5 with a sampling time of 25 μ s, the spreading factor (α) is a factor that controls the spreading of the generated signal, it can be between 5 % and 27 %.

Fig. 4. shows the spectrogram of the PLC signal measured at point 2 in Fig. 2, near the receiving modem. The G3-PLC standard operates between 35 kHz and 91 kHz, the amplitude of the PLC signal in the intermediate frequency of the signal (at 63kHz) is 76 dBuV.

Due to the coupling path between both circuits, the effect of the converter appears in the PLC system performance. The measured spectra for different values of α are shown in Fig. 5. These were measured at the PLC side, i.e. at point 2 in Fig. 3. It can be seen that increasing values of α give lower peak amplitudes and an increased spreading effect for the signal power.

The tests are performed by changing the value of α , i.e. varying the spreading in the RCFMFD modulation. The Frame Error Rate (FER) is a good indicator for the PLC performance in the presence of the EMI source [21], it is defined as the ratio between the broken frames data to the reference sent data, it is represented in percentage as

$$FER(\%) = \frac{\text{Broken Frames}}{\text{Reference Frames}} \times 100 \quad (4)$$

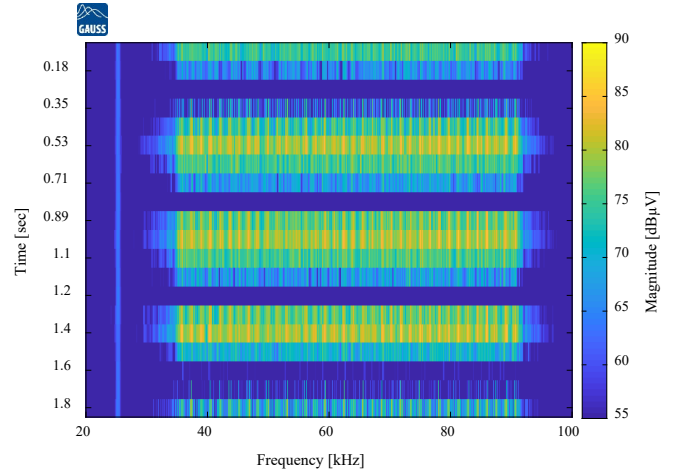

Fig. 4. Spectrogram of the G3-PLC signal

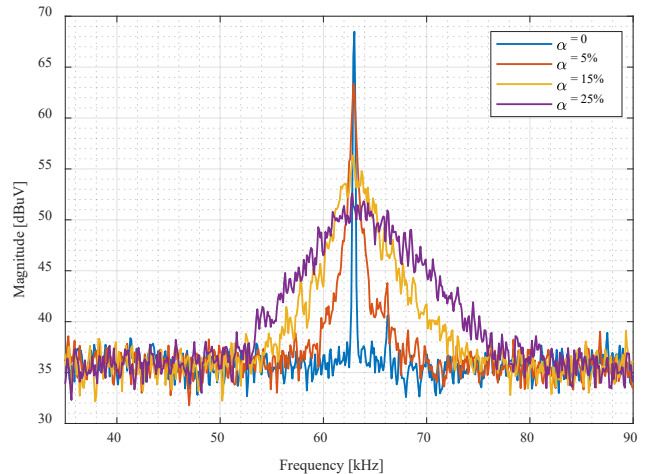

Fig. 5. The spectrum of the measured voltage at the PLC circuit side in case of different spreading factor α values and no PLC signal.

The highest probability of erroneous data transmission appears in the case of $\alpha = 27\%$. This effect is contradictory to the conventional assumption: “when applying spread spectrum techniques EMI is being mitigated”. In the following section, the channel capacity is investigated to explain this contradicting phenomenon. Fig. 6 shows the impact of the converter modulation on the PLC signal and it reveals that the FER percentage increase with increasing α .

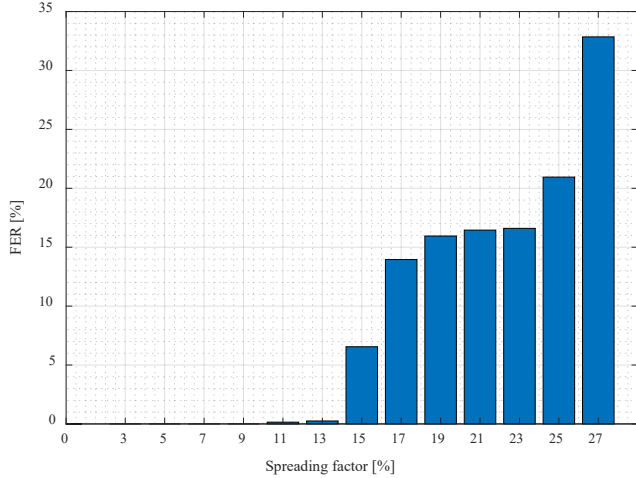

Fig.6. FER vs Spreading factor.

V. RESULTS EVALUATION

Based on the results, the Shannon-Hartley [22] equation is used to evaluate the PLC channel capacity, which corresponds to the maximum rate of data that can be transmitted over a communications channel in the presence of noise and which can be approached in communication systems featuring advanced channel coding like forward error correction (FEC) codes adopted in G3-PLC and PRIME. Following the procedure presented in [22], the data in the G3-PLC channel is used in conjunction with the spread EMI for different values of the spreading factor. The capacity of the PLC channel can be expressed as:

$$C_{\text{PLC}} = \int_{B_{\text{min}}}^{B_{\text{max}}} \log_2 \left(1 + \frac{S(f)}{N(f)} \right) df \quad (5)$$

where B_{min} and B_{max} represent the minimum and the maximum frequencies of the PLC bandwidth channel, $S(f)$ is the power spectral density of the PLC signal and $N(f)$ is the total noise power spectral density. In the case of a noise-free PLC channel, the N represents the AWGN with spectral power density equal to N_0 , however, in the case of an additional EMI source, N can be considered to be:

$$N(f) = S_{\text{EMI}}(f) \quad (6)$$

where S_{EMI} is the power spectral density of the spread conducted noise with the AWGN. Fig. 7 shows the capacity of the PLC channel after applying equation (5) for the measured power spectral density of each spreading factor ranging from 0% to 27%, the results show that the channel capacity value decreases with increasing α in the randomized signal. The channel data loss percentage can be calculated as:

$$C_{\text{Loss}}(\%) = \frac{C_0 - C_{\text{PLC}}}{C_0} \times 100\% \quad (7)$$

where C_0 is the calculated capacity of the PLC channel in a noise-free case, i.e. only including the AWGN. Fig. 7 shows the channel capacity loss calculated from equation (7).

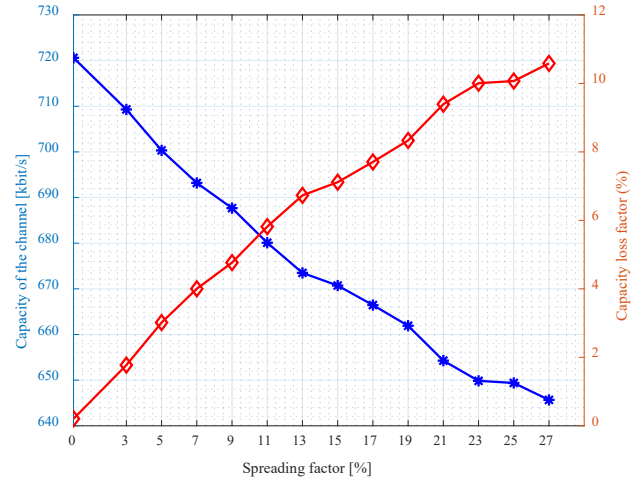

Fig.7. The capacity of the channel and capacity loss percentage

Even if the channel capacity (in the 700 kbps range) is just an upper bound of the achievable bit rate and the actual G3-PLC and PRIME rate is significantly lower (in the order of 100kbs), thus revealing a clear correlation between theoretical capacity loss and empirical error rate related to the adoption of Spread Spectrum modulation.

VI. CONCLUSION

This paper analyzes the impact of spread spectrum electromagnetic conducted emissions on the G3-PLC performance, the experimental setup is implemented to emulate a real situation in the case of mutual coupling between the power circuit cables and PLC cables. The results show that despite the decrease in the spectrum amplitude provided by the randomized PWM techniques, they deliver more problems to the PLC performance. Furthermore, the increase in the spreading factor α in the used technique is followed by an increase in the percentage of the frame error rate of the sent data. Finally, the Shannon-Hartley channel capacity equation is used to confirm the behavior of the spread spectrum techniques, the capacity of the channel decreases with the increase of the spreading factor α . Based on the experimental results, spread spectrum techniques offer a spectrum peak reduction which helps to cope with EMC standards but may provide more problems to the communication systems in the smart grid networks. The results can be used in the future as a guideline for the EMC standards, considering the suitable parameters setting of a randomized PWM technique utilized for the power converters in the smart grid environment.

ACKNOWLEDGMENT

This paper is part of a project that has received funding from the European Union’s Horizon 2020 research and innovation program under the Marie Skłodowska-Curie grant agreement No 812391 – SCENT.

REFERENCES

- [1] J. Meyer *et al.*, "Overview and Classification of Interferences in the Frequency Range 2-150 kHz (Supraharmonics)," in *SPEEDAM 2018 - Proceedings: International Symposium on Power Electronics, Electrical Drives, Automation and Motion*, 2018, pp. 165–170.
- [2] P. S. Crovetto and F. Musolino, "Interference of Spread-Spectrum EMI and Digital Data Links under Narrowband Resonant Coupling," *Electronics*, vol. 6, no. 90, pp. 1–18, 2020.
- [3] F. Musolino and P. S. Crovetto, "Interference of Spread-Spectrum Switching-Mode Power Converters and Low-Frequency Digital Lines," in *2018 IEEE International Symposium on Circuits and Systems (ISCAS)*, 2018, p. 5.
- [4] M. Schwarz and F. Gronwald, "EMI analysis of a generic power line communication OFDM data link," in *Proceedings of EMC Europe 2011 York - 10th International Symposium on Electromagnetic Compatibility*, 2011, pp. 625–628.
- [5] K. Li, Y. Xie, F. Zhang, and Y. Chen, "Statistical Inference of Serial Communication Errors Caused by Repetitive Electromagnetic Disturbances," *IEEE Trans. Electromagn. Compat.*, vol. PP, pp. 1–9, 2019.
- [6] H. Meng, Y. L. Guan, and S. Chen, "Modeling and analysis of noise effects on broadband power-line communications," *IEEE Trans. Power Deliv.*, vol. 20, no. 2, pp. 630–637, 2005.
- [7] H. Loschi, P. Lezynski, R. Smolenski, D. Nascimento, and W. Sleszynski, "FPGA-Based System for Electromagnetic Interference Evaluation in Random Modulated DC / DC Converters," *Energies* 2020, vol. 13, no. 2389, pp. 1–14, 2020.
- [8] Y. Lai, S. Member, and Y. Chang, "Novel Random-Switching PWM Technique With Constant Sampling Frequency and Constant Inductor Average Current for Digitally Controlled Converter," *IEEE Trans. Ind. Electron.*, vol. 60, no. 8, pp. 3126–3135, 2013.
- [9] F. Pareschi, R. Rovatti, and G. Setti, "EMI reduction via spread spectrum in DC/DC converters: State of the art, optimization, and tradeoffs," *IEEE Access*, vol. 3, pp. 2857–2874, 2015.
- [10] P. Lezynski, R. Smolenski, H. Loschi, D. Thomas, and N. Moonen, "A novel method for EMI evaluation in random modulated power electronic converters," *Measurement*, vol. 151, no. 107098, p. 9, 2020.
- [11] J. Bojarski, R. Smolenski, P. Lezynski, and Z. Sadowski, "Diophantine equation based model of data transmission errors caused by interference generated by DC-DC converters with deterministic modulation," *Bull. POLISH Acad. Sci. Tech. Sci.*, vol. 64, no. 3, pp. 575–580, 2016.
- [12] W. El Sayed, H. Loschi, M. A. Wibisono, N. Moonen, and P. Lezanki, "The Influence of Spread-Spectrum Modulation on the G3-PLC Performance," in *2021 ASIA PACIFIC INTERNATIONAL SYMPOSIUM ON ELECTROMAGNETIC COMPATIBILITY*, 2021, vol. Submitted.
- [13] B. Auinger, B. Deutschmann, and G. Winkler, "Elimination of electromagnetic interference in communication channels by using spread spectrum techniques," in *2017 International Symposium on Electromagnetic Compatibility - EMC EUROPE 2017, EMC Europe 2017*, 2017.
- [14] I. Fernandez *et al.*, "Characterization of non-intentional emissions from distributed energy resources up to 500 kHz: A case study in Spain," *Int. J. Electr. Power Energy Syst.*, vol. 105, no. April 2018, pp. 549–563, 2019.
- [15] G. López, J. I. Moreno, E. Sánchez, C. Martínez, and F. Martín, "Noise sources, effects and countermeasures in narrowband power-line communications networks: A practical approach," *Energies*, vol. 10, no. 8, pp. 1–41, 2017.
- [16] J. Matanza, S. Alexandres, and C. Rodriguez-Morcillo, "Performance evaluation of two narrowband PLC systems: PRIME and G3," *Comput. Stand. Interfaces*, vol. 36, no. 1, pp. 198–208, 2013.
- [17] M. Hoch, "Comparison of PLC G3 and PRIME," in *2011 IEEE International Symposium on Power Line Communications and Its Applications, ISPLC 2011*, 2011, pp. 165–169.
- [18] F. E. utility company (ERDF), "PLC G3 Physical Layer Specification," *Project PLC G3 OFDM*, pp. 1–46, 2009.
- [19] A. Llano, I. Angulo, P. Angueira, T. Arzuaga, and D. De Vega, "Analysis of the Channel Influence to Power Line Communications Based on ITU-T G . 9904 (PRIME)," *Energies* 2016, vol. 9, no. 39, pp. 1–16, 2016.
- [20] Y. Lai, Y. Chang, and B.-Y. Chen, "Novel Random-Switching PWM Technique With Constant Sampling Frequency and Constant Inductor Average Current for Digitally Controlled Converter," *IEEE Trans. Ind. Electron.*, vol. 60, no. 8, pp. 3126–3135, 2013.
- [21] M. A. Wibisono, N. Moonen, and F. Lefeink, "Interference of LED Lamps on Narrowband Power Line Communication," in *2020 IEEE International Symposium on Electromagnetic Compatibility & Signal/Power Integrity (EMCSI)*, 2020, pp. 219–221.
- [22] F. Musolino and P. S. Crovetto, "Interference of Spread-Spectrum Modulated Disturbances on Digital Communication Channels," *IEEE Access*, vol. 7, pp. 158969–158980, 2019.