

Evaluation of the effect of profile modifications in gears subjected to sudden torque inversion

Original

Evaluation of the effect of profile modifications in gears subjected to sudden torque inversion / Bruzzone, F; Maggi, T; Marcellini, C; Rosso, C; Delprete, C. - In: IOP CONFERENCE SERIES: MATERIALS SCIENCE AND ENGINEERING. - ISSN 1757-8981. - ELETTRONICO. - 1038:(2021), p. 012014. (The 49th AIAS Conference (AIAS 2020) Genoa 2-5 september) [10.1088/1757-899X/1038/1/012014].

Availability:

This version is available at: 11583/2923632 since: 2021-09-14T11:36:14Z

Publisher:

IOP PUBLISHING LTD

Published

DOI:10.1088/1757-899X/1038/1/012014

Terms of use:

This article is made available under terms and conditions as specified in the corresponding bibliographic description in the repository

Publisher copyright

(Article begins on next page)

PAPER • OPEN ACCESS

Evaluation of the effect of profile modifications in gears subjected to sudden torque inversion

To cite this article: F Bruzzone *et al* 2021 *IOP Conf. Ser.: Mater. Sci. Eng.* **1038** 012014

View the [article online](#) for updates and enhancements.



240th ECS Meeting ORLANDO, FL

Orange County Convention Center Oct 10-14, 2021



Abstract submission due: April 9

SUBMIT NOW

Evaluation of the effect of profile modifications in gears subjected to sudden torque inversion

F Bruzzone^{1,2}, T Maggi^{1,2}, C Marcellini^{1,2}, C Rosso^{1,2} and C Delprete¹

¹ Politecnico di Torino, Corso Duca degli Abruzzi, 24, 10129 Torino

² GeDy TrAss, Via Vela 42, 10129 Torino

E-mail: carlo.rosso@polito.it

Abstract. The search for propulsion systems of vehicles with lower environmental impact is focusing on systems with exclusive or supplementary use of electric motors. In fully electric or hybrid vehicles, the electric power delivery is used not only to provide torque to the vehicle and the consequent movement of the vehicle, but also to transform the vehicle's kinetic energy back into electrical energy for storage in batteries when the vehicle is downhill or it must be slowed down. Under normal operating conditions, even in urban usage, it is common to have sudden inversions of the power flow. This means that in a really short time the motor switches from delivering torque to receiving it. Normally the electric motor is not directly connected on the wheels, but a geared transmission is present. The change of torque from positive (motor) to negative (generator) causes a sudden change of the working conditions. This induces vibrational and durability problems on the gears. In the present paper, an accurate model of mesh dynamics is proposed, capable of considering the inversion of the power flow. This model evaluates the forces exchanged between the teeth both with the variation of the torque and the rotation speed. Through the evaluation of the variation in gear stiffness it allows to evaluate the transmission response to different operating conditions. The possibility of establishing which side is in contact and which is the direction of the force exchanged between the mating teeth allows to evaluate the effect on the dynamic response of the system. In this way it is possible to decide which is the best shape of the teeth which minimises the dynamic response of the system in all operating conditions, including torque inversion.

1. Introduction

A wide number of publications in literature is related to the engagement dynamics and the gear dynamics. The first scientific analyses of the gear dynamics were established in the Twenties and Thirties of the XX^{th} century and they were related to the evaluation of the dynamic overload due to the teeth mating. In the Fifties of the XX^{th} century, the first studies based on the dynamic models were conducted, with the aim to understand the overload in the engagement. More recently, in the Seventies and Eighties, complex models were introduced in order to improve the accuracy of the developed models considering the effect of the tooth tridimensionality, the non-linearities in the principal elements and the friction and lubrication effects [1]. From Nineties up to now, the wide diffusion and the increasing computation capabilities of the computers enriches the literature of complex Finite Element and Multibody models for taking into account the macro and micro geometrical features of the gears, the complex deformation of the gearbox components and the time evolution of the engagement. The wide number of studies has different goals, in fact, some of them, the earlier, are oriented to evaluate the Dynamic Factor, i.e. the



Content from this work may be used under the terms of the [Creative Commons Attribution 3.0 licence](https://creativecommons.org/licenses/by/3.0/). Any further distribution of this work must maintain attribution to the author(s) and the title of the work, journal citation and DOI.

load increment due to the dynamics. Others are related to the engagement dynamics and for this reason they focus their attention on the tooth compliance. To study the effects of the gear dynamics on the system, complex models that consider the shaft and bearing compliances are proposed. For high spin speed system, the gyroscopic effects are also taken into account by complex rotor dynamics model of geared system, and other models study the noise and vibration of gearboxes by means of Multibody and Finite Element techniques [2]. The common line of all the literature models and techniques is the evaluation of the dynamic behaviour of geared system. Nowadays, the electric vehicle (EV) market requires geometries more and more optimized and lighter materials, for these reasons it is necessary to put particular attention on the dynamic overloads. Due to the fact that the EV does not have a combustion motor, the gearbox noise is not covered anymore hence Noise, Vibration and Harshness (NVH) simulations become fundamental. Due to a wide operative range, these gears must be well designed looking for the best compromise in terms of NVH behaviour with respect to the load spectrum: this is usually done by applying micro-geometry modifications to the teeth flank. Furthermore, in hybrid vehicles during regenerative braking the gears are subject to torque inversion that could generate dynamic overloads and non-linear effects that can potentially affect gearbox durability.

2. Materials and Methods

Matlab Simulink was used as framework for the implementation of the model. In the following subsections, all the components of the model are described and finally a description of the solution parameters is given.

2.1. Gear mating model

The model implemented for the description of mating gear dynamics is monodimensional, originating from the literature and in particular the 1D model proposed by Parker [3]. This model is single degree of freedom, as shown in Figure 1 and it takes into account two rigid gears, whose inertia properties are referred to the base radii. Along the line of action, the displacements of contact points (x_1 for pinion and x_2 for the gear) are the unique information that describes the model kinematics, and the difference between those displacements is the unique degree of freedom of the model. So if $p = x_1 - x_2$ is the quantity useful for the dynamic model, an equivalent inertia, combination of the gear inertias, can be defined. In such a way the 1D model becomes more or less a traditional mass-spring-damper model. The equivalent inertia is defined as

$$m_e = \frac{I_1 I_2}{I_1 \left(\frac{d_{b2}}{2}\right)^2 + I_2 \left(\frac{d_{b1}}{2}\right)^2} \quad (1)$$

where I_i are the gear rotational inertias and $d_{b,i}$ are the gear base diameter. The two other dynamic parameters are the stiffness and the damping. The damping c_m is a constant value and it is extracted from literature, ξ in literature typically ranges from 0.08 to 0.1. The stiffness k_m is the elasticity referred to the teeth contact, so it considers all the compliances involved in the contact (Hertzian compliance, tooth bending compliance, web compliance...). Parker et al. consider the Static Transmission Error (STE) as an intrinsic characteristic of the model and not as input, as in other literature approaches. As a matter of fact, the STE is generated by the natural variation of the meshing stiffness, so Parker's model considers the meshing stiffness variable in time. The fundamental equation is not so different from other 1d approaches, the differences are located in the definition of the meshing stiffness. In other literature approaches the stiffness is constant apart the dead zone due to backlash. In Parker's methodology the stiffness varies with the engagement and the non-linearity due to the backlash is represented by a simple condition: elastic force is equal to zero when the teeth are not in contact and it varies

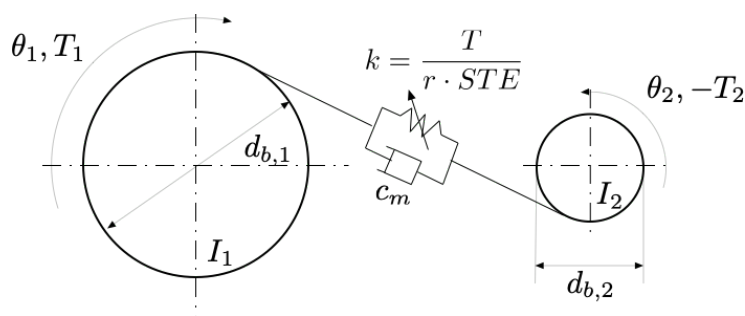

Figure 1. 1D model proposed by Parker

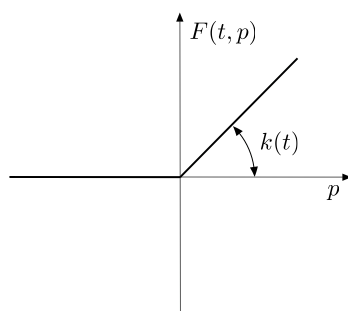

Figure 2. Stiffness representation used by Parker

according to the engagement when the two mating teeth are in contact. In that way the motion equation is simple and it can be written as:

$$m_e \ddot{p} + c_m \dot{p} + F(t, p) = P_b \tag{2}$$

where P_b represents the mean value of force exchanged by teeth in contact along the line of action, $F(t, p)$ is the non linear elastic force that has the trend of Figure 2 and p is the displacement between the two gears contact points along the line of action. So elastic force is acting only when teeth are in contact on the proper flank. If the contact is lost, for example during excessive vibration, elastic force is always zero. In such a way it is not possible to highlight any possible backside contact, i.e. when the tooth closes the gap on the opposite flank.

Recently, Parker updated the methodology by considering the stiffness as a function of torque and angular position [4] [5]. In order to be more complete and to be able to analyse also the backside contact, the Parker’s model is modified in order to describe the gear meshing stiffness as a lookup table, function of torque and angular position and the possibility to check if the contact is correct, is lost, or is on the other flank. To create the table for describing the stiffness, the GeDy TrAss software is used [6]. A range of torques is selected (from 100 to 500 Nm) and as output of the code the STEs of several engagement angles of the two mating gear are produced. In Figure 3 the results are depicted.

In addition, a check on the tooth position is implemented by comparing the relative displacement between the two mating surfaces with the backlash entity. In other words, if the displacement between the two teeth surfaces is higher than the half of the backlash value (the overall value of the backlash is identified by $2b$), it is assumed that the contact is on the proper side and the stiffness is evaluated using the lookup table previously derived. If the displacement along the line of action reaches a value within the backlash values, the stiffness of

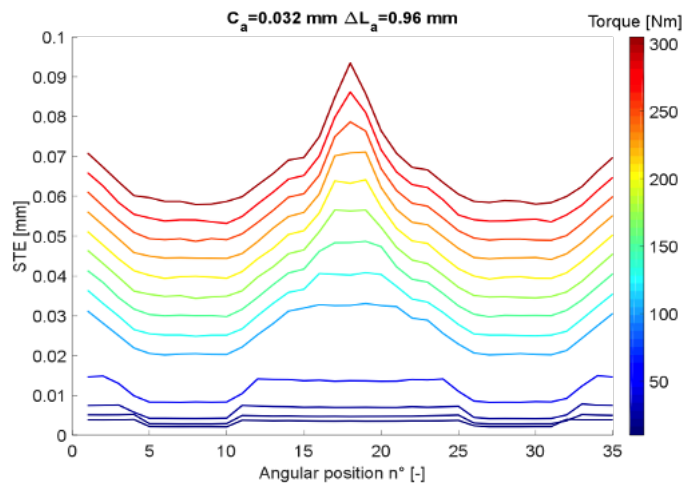

Figure 3. STE for different torque along a engagement pitch

the contact is zero, because no contacts are present. If the displacement is lower than the half of the backlash, the contact takes place on the opposite flank, giving rise to the backside contact. In such a way the stiffness is again derived by the lookup table. In table 1, model options are resumed and in Figure 4 is graphically depicted.

Table 1. Displacement check for non linear modelling.

Condition	Contact	Color
$p > b$	Proper contact, stiffness evaluated by means of the lookup table	blue
$-b \leq p \leq b$	Absence of contact	green
$p < -b$	Backside contact, stiffness evaluated by means of the lookup table	red

2.2. Matlab Simulink implementation

As the gear mating model is defined, its implementation in Matlab Simulink is tackled [7]. In order to create the time integration model, the non linear motion equation is written. The starting point is rearranging the motion equation as

$$p''(t) = \frac{T(t)}{r_b \cdot m_{eq}} - \frac{K(t)}{m_{eq}}p(t) - \frac{c}{m_{eq}}p'(t) \quad (3)$$

where $T(t)$ is the torque, that can change in time, $K(t)$ is the stiffness value derived by means of the gear mating model and c is the damping, set at a constant value as in literature.

In Figure 5, the implementation of equation 3 is depicted. In the big sum symbol, five addends are implemented. One is related to the damping contribution (lower arrow), one to the inertia contribution (the arrow with plus sign) and the other three arrows related to the stiffness contribution.

In Figure 6, the simulink model uses for implementing the non linear logic of table 1 is reported. In such a way three outputs are always generated, but the check multiplies for 0 or

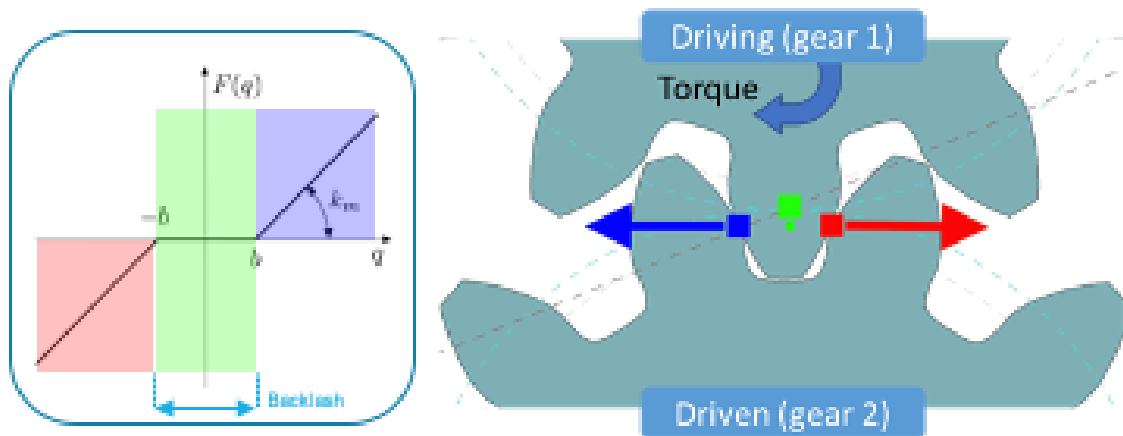

Figure 4. Model behaviour graphically depicted.

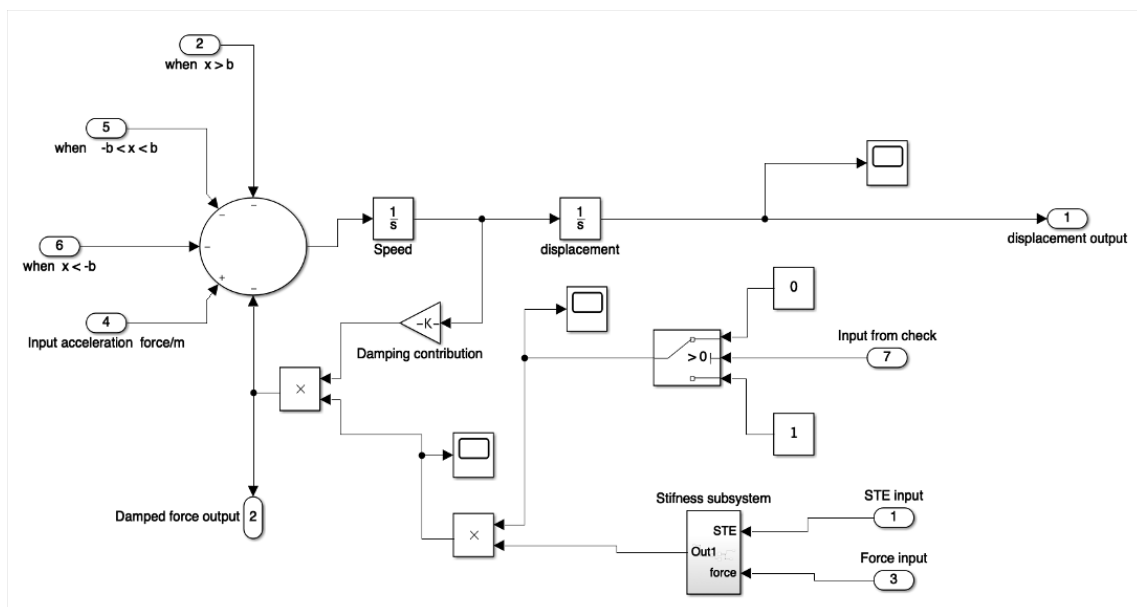

Figure 5. Simulink implementation of the numerical integration of motion equation

1 the output depending on the contact condition. In the big sum of Figure 5 the three inputs are always present, but only one of them is different from zero, the one that corresponds to the proper contact condition. In other words, the stiffness values are always computed, but on the basis of the contact condition, the stiffness value is multiplied by one if the contact condition is satisfied or zero in other conditions.

3. Case study

In order to validate the model, a case study is analysed. In particular, two equal gears are considered, in table 2 features are collected.

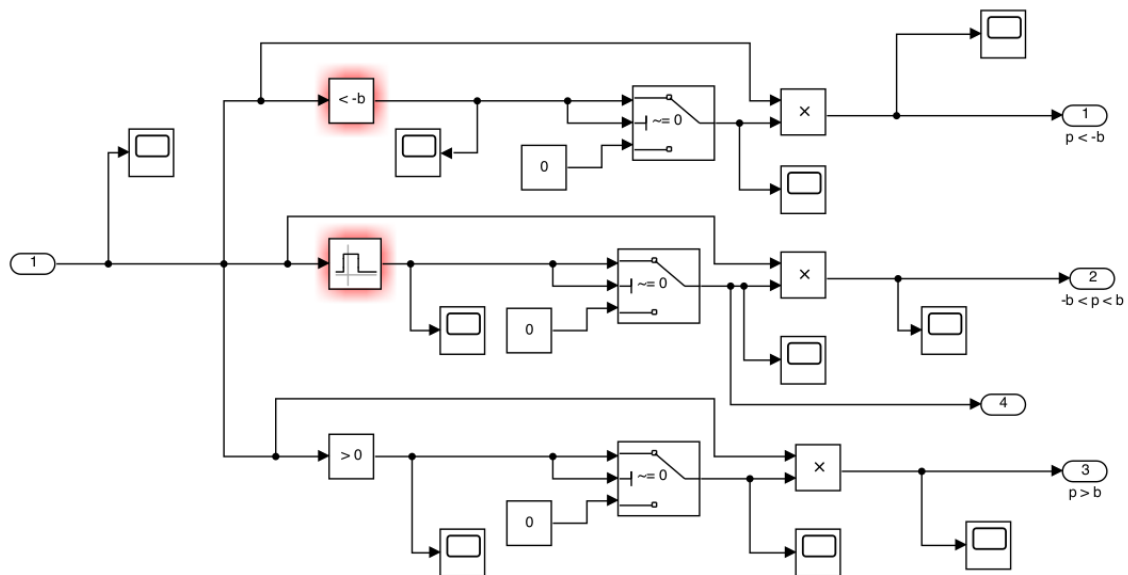

Figure 6. Non linear modelling of contact.

Table 2. Case study: gears considered for model validation

Characteristic	Value
Number of teeth (z)	28
Tooth rack profile	standard
Gear ratio (τ)	1
Pressure angle ($^\circ$)	25
Base diameter (mm)	126.88309
Face width (mm)	6.35
Gear polar inertia (kgm^2)	25
Equivalent mass m_e (kg)	0.5275
Nominal backlash (m)	$2.5e^{-4}$
Operative range (rpm)	0-7500
Damping (%)	0.08

3.1. Standard profile: dynamic response

Numerical analysis was performed using a standard profile of the gear with the nominal backlash, and the dynamic behaviour was evaluated. The simulation process was set giving a speed ramp up from zero to 7500 rpm and back in 20 seconds. The time integrator used was a Variable Step Dormand-Prince algorithm with a relative tolerance and a maximum time step of $1e^{-6}$, whereas the minimum step and the absolute tolerance were selected automatically by the algorithm. In Figure 7, the dynamic force exchanged by engagement for the nominal gear profile under a constant torque of 100 Nm is reported. It can be noticed the typical non linear behaviour due to the contact loss and the related jump phenomenon. In the highlighted areas, the condition of contact loss is remarked. Three regimes can be emphasised, the " n_1 " zone, where the resonance is in correspondence of the double of the spin speed, the " n_2 " zone, the principal resonance zone (spin speed equal to the natural frequency of the engagement) and the supercritical " n_3 " area,

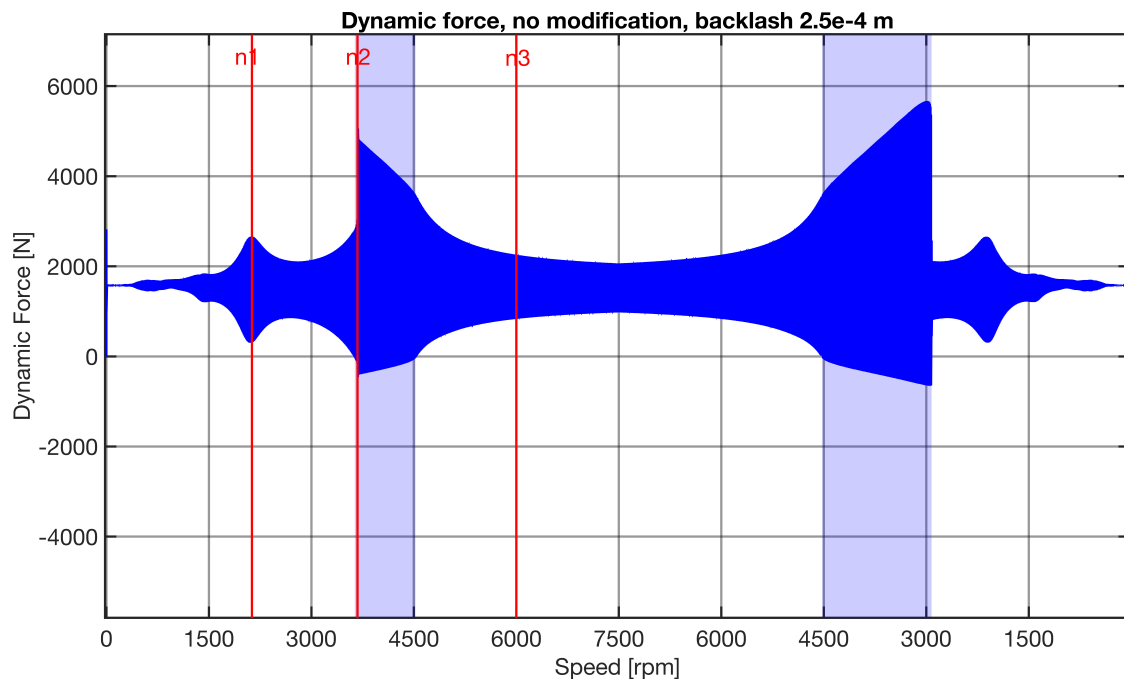

Figure 7. Dynamic force for standard profile of the gear

where the dynamic perturbation comes to a stabilisation.

3.2. Backlash modification: dynamic response

By maintaining the same model setup, but changing the backlash value and, in particular, reducing it of an order of magnitude, the dynamic force was computed. In Figure 8 it is possible to notice the presence of the third contact condition, i.e. the back side contact, particularly referred to the major resonance of the system. It is also possible to predict the increment of the dynamic force with respect to the nominal condition.

3.3. Profile modification: dynamic response

Two simple tip corrections are implemented for understanding the importance of the profile modification on gear dynamic answer. In table 3 the tip relief features are summarised and in Figure 9 the geometric quantities are shown.

Table 3. Tip relief features

#	C_a	ΔL_a
a	0.032 mm	0.96 mm
b	0.032 mm	3.00 mm

In Figure 10 it is possible to highlight the change in STE due to the modification and in Figure 11 it is possible to compare the different dynamic answer of the same gearset with different profile modification. It is worth noting that the backlash is set to nominal condition.

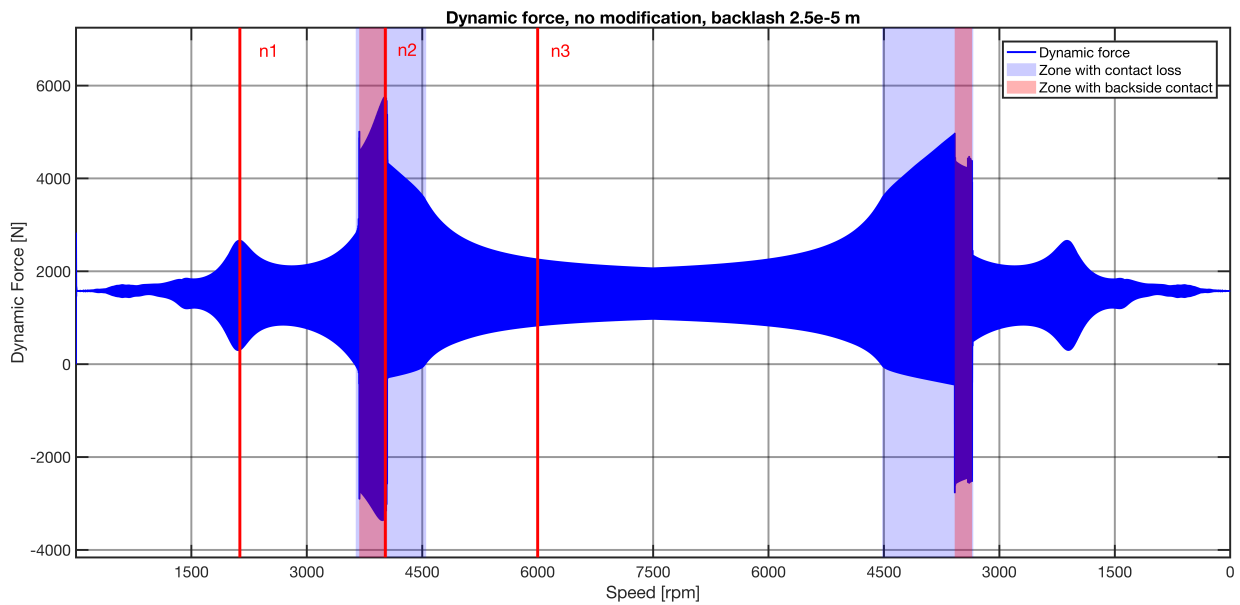

Figure 8. Dynamic force for reduced backlash gears

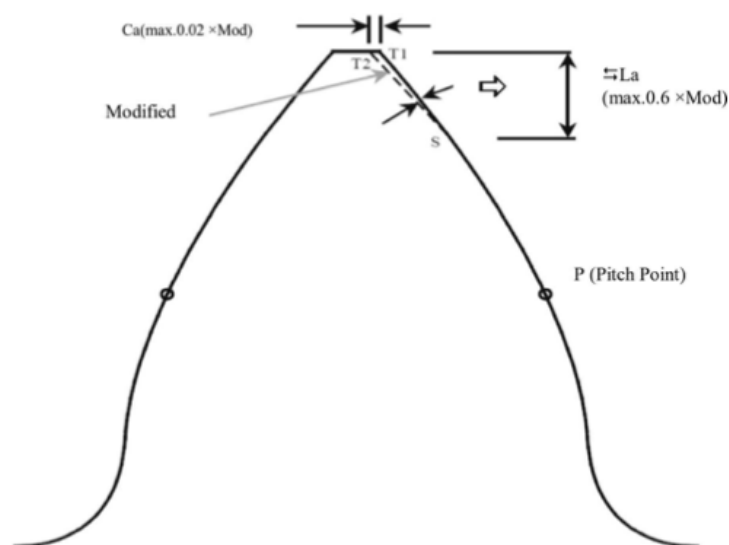

Figure 9. Graphical representation of tip relief correction

STE comparison between gears with different tooth profile modifications at 100 Nm with 2.5×10^{-4} m of backlash

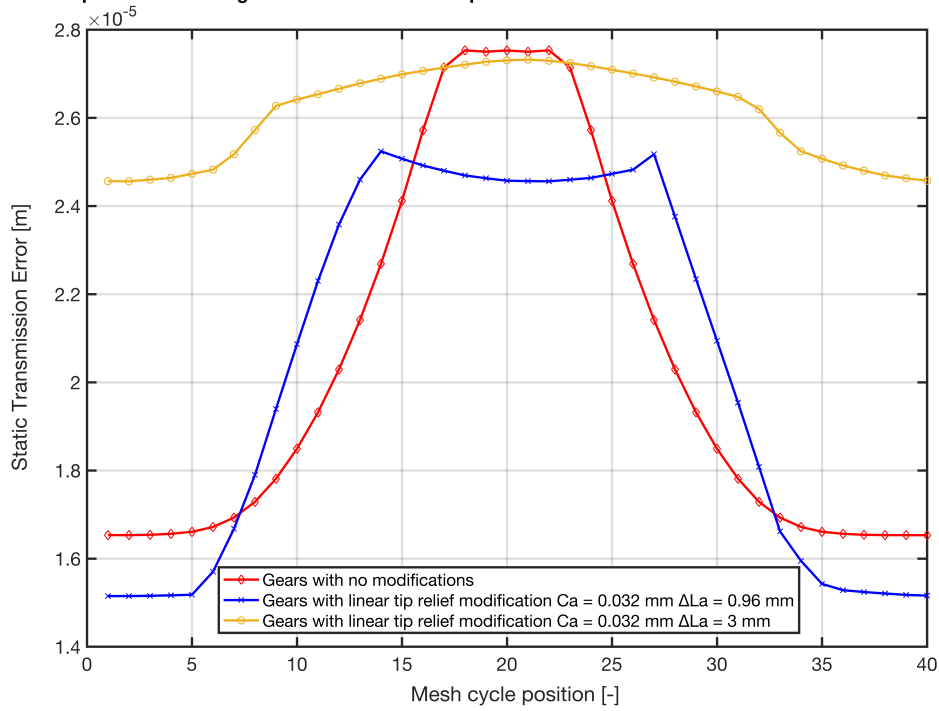

Figure 10. STE comparison at different profile modifications

Dynamic force comparison between gears with different tooth profile modifications at 100 Nm with 2.5×10^{-4} m of backlash

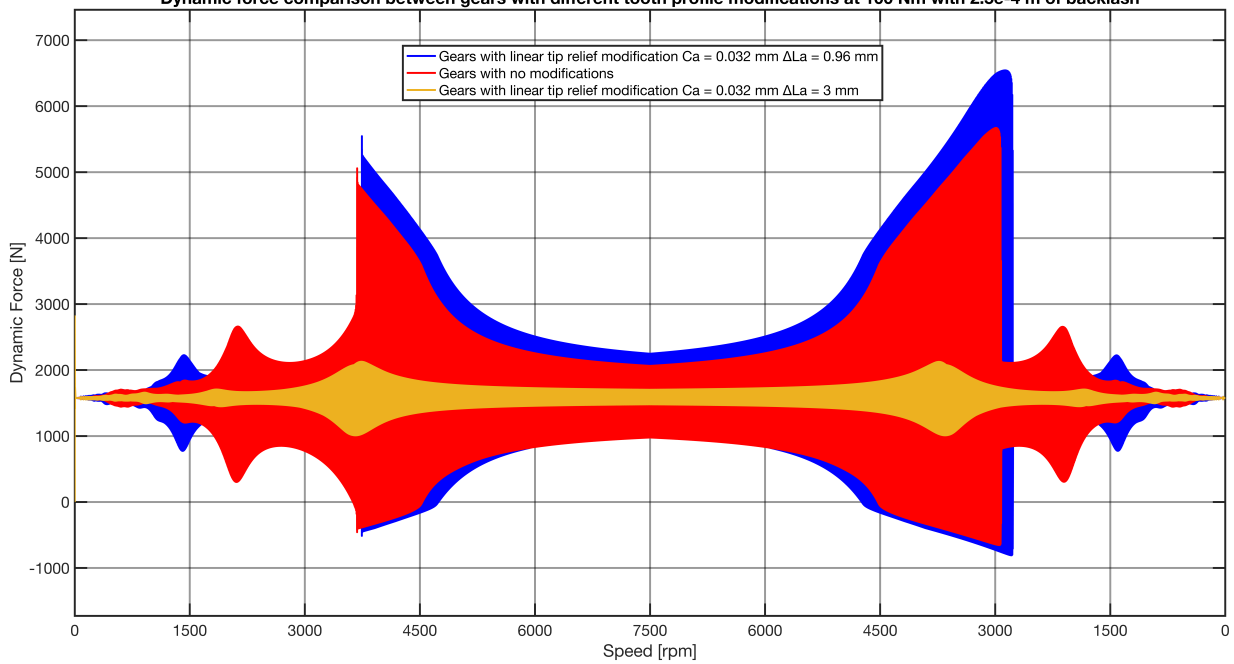

Figure 11. Comparison of the Dynamic Force of the gearset at different profile modification.

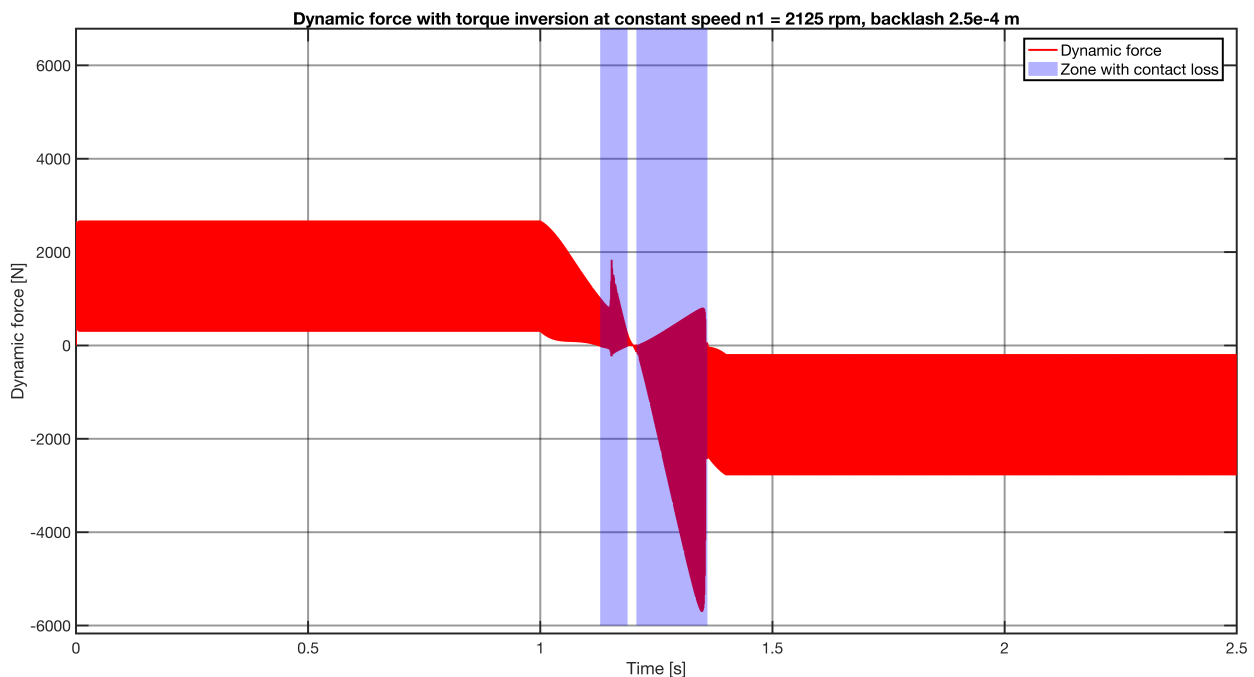

Figure 12. Dynamic force during torque inversion at low speed, n_1 region

It is important to notice that the "a" modification does not provide a significant improvement, instead it increase the dynamic force exchanged. Whereas the "b" modification is capable of greatly reducing the dynamic force also avoiding the onset of contact loss even in the main resonance condition.

3.4. Standard profile: torque inversion

Torque inversion is simulated as a sudden change in the value of torque and in the following the nominal torque of 100 Nm is changed in 0.4 seconds in -100 Nm, in order to simulate the change in electric machine behaviour (from motor to generator). The solution algorithm remained the same of previous case, but torque varied and spin speed remained constant. In Figures 12,13,14 the dynamic force exchanged at the three characteristic speeds are reported. For the " n_1 " region (Figure 12), contact loss during torque inversion is predicted, whereas for the other to speed condition no contact loss is highlighted during torque inversion, but the contact loss is strongly present in " n_2 " region, as predicted by sweep analysis. In region " n_2 " no important dynamic phenomena take place.

3.5. Backlash reduction: torque inversion

In Figures 15,16,17 the dynamic force exchanged at the three characteristic speeds are reported for the gears with reduced backlash. As in the previous case, the backlash is reduced of an order of magnitude. For the " n_1 " region (Figure 15), contact loss and back side contact during torque inversion is predicted, whereas for the other to speed condition no contact loss is highlighted during torque inversion. For the " n_2 " area back side contact is present, whereas no important dynamic effects are present in " n_3 " region.



Figure 13. Dynamic force during torque inversion at resonance, n_2 region

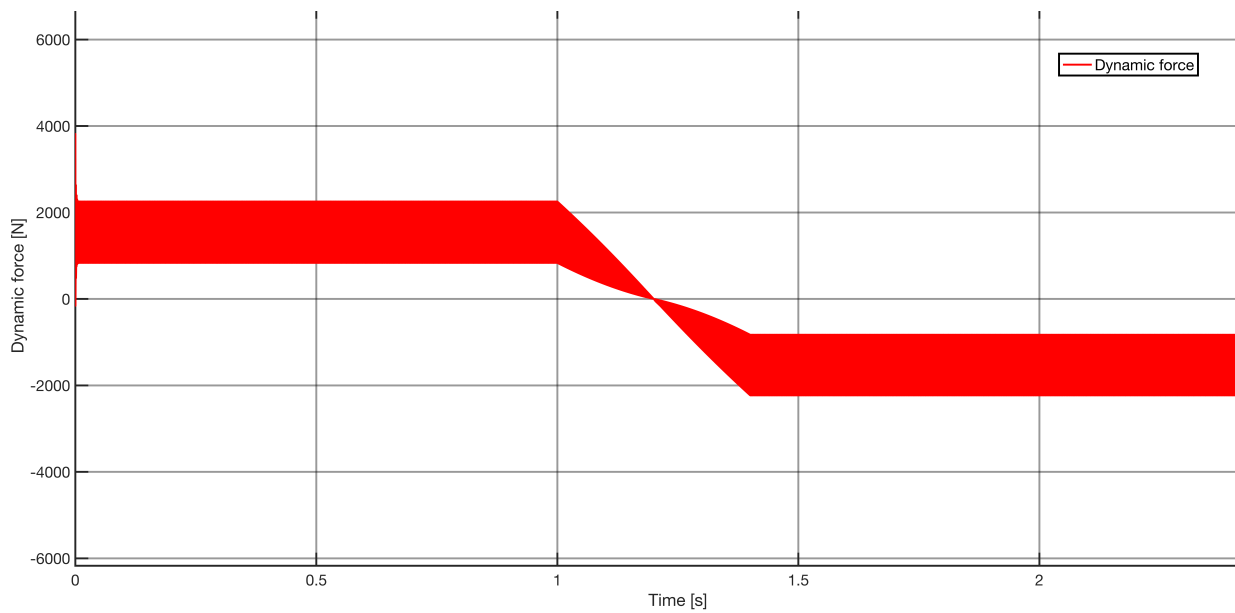

Figure 14. Dynamic force during torque inversion at high speed, n_3 region

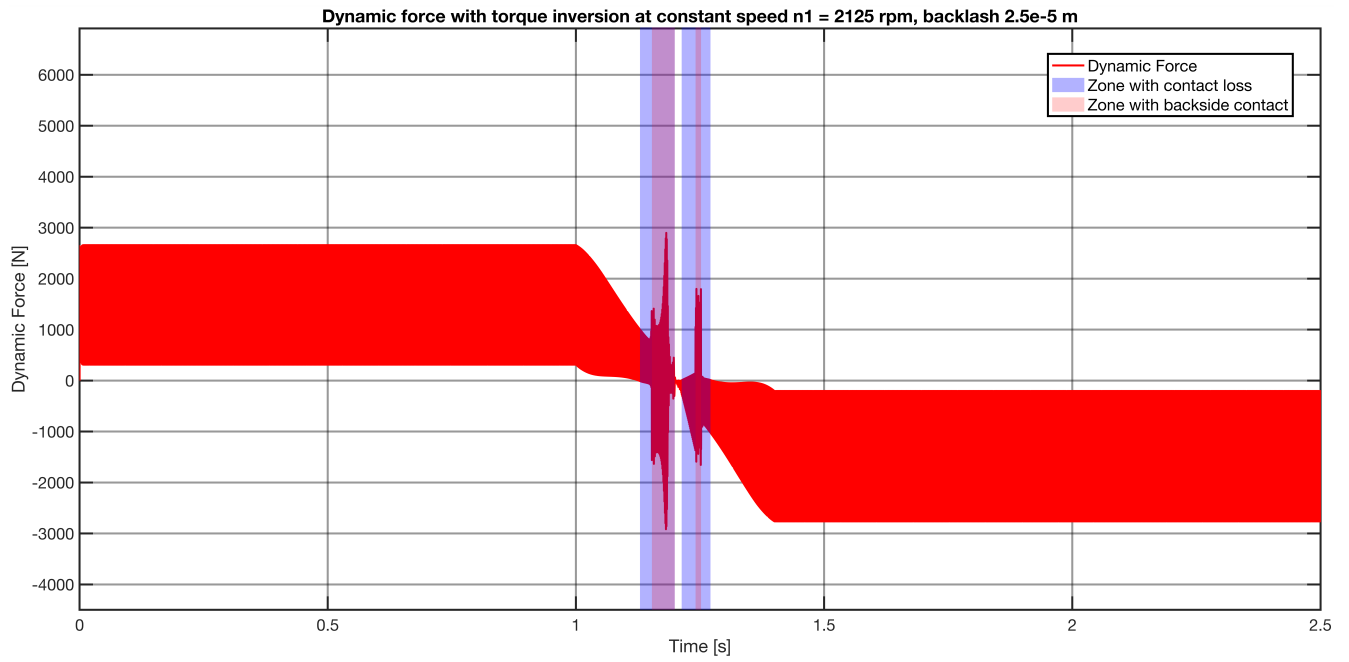

Figure 15. Dynamic force during torque inversion at low speed, n_1 region with lower backlash

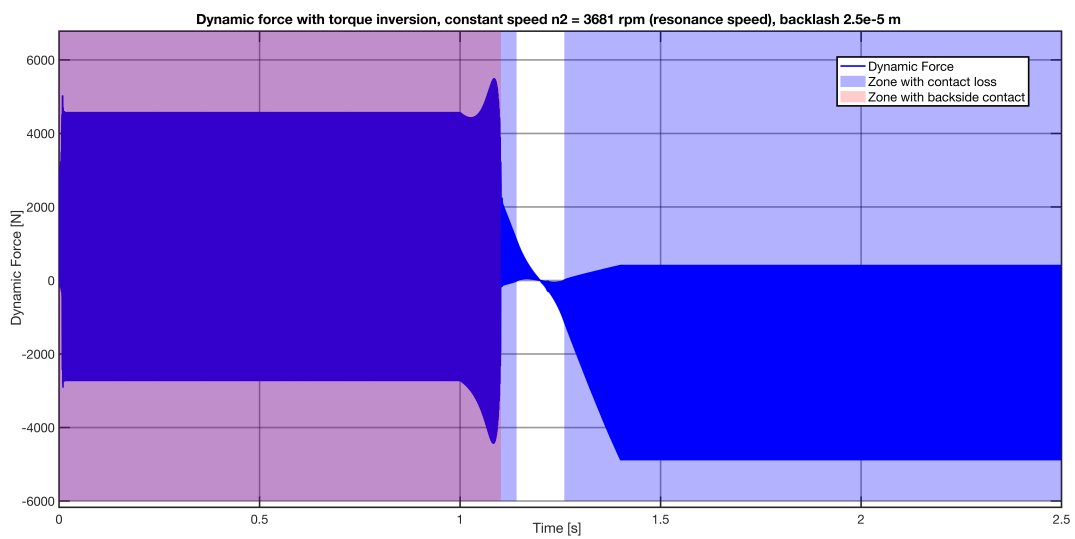

Figure 16. Dynamic force during torque inversion at resonance, n_2 region with lower backlash

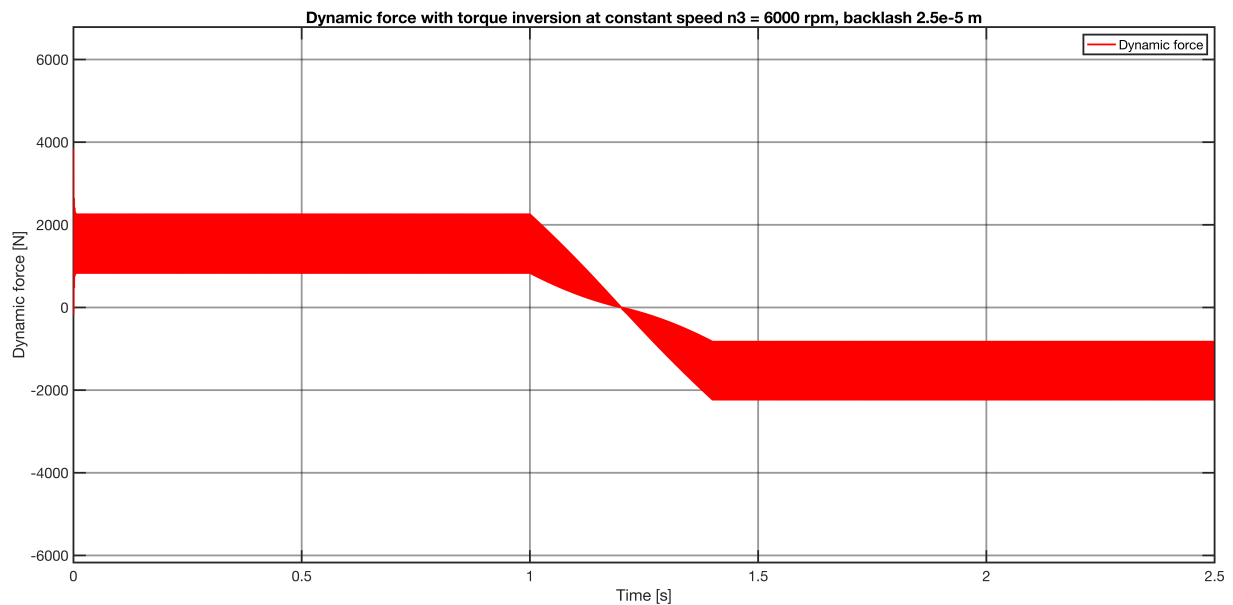

Figure 17. Dynamic force during torque inversion at high speed, n_3 region with lower backlash

3.6. Profile modification case "a": torque inversion

The same analysis was conducted also for the profile modification. Starting with the "a" modification, in Figures 18, 19, 20 the dynamic force exchanged at the three characteristic speeds are reported. No great difference from the unmodified condition can be highlighted.

3.7. Profile modification case "b": torque inversion

By using the type "b" modification, important reduction of dynamic forces is also highlighted during all the working condition phases. The worst condition is reported in Figure 21 where the torque inversion at resonance condition is performed. No particular dynamic effects are reported.

4. Conclusion

By comparing the results reported, it can be concluded:

- the proposed model is capable of highlighting non linear behaviour of the mating gears and it is sensible to the micro-geometry modifications;
- the model can predict the contact loss and the back side contact with an estimation of the exchanged forces;
- different working conditions can be simulated, torque change, speed change, torque inversion
- the profile modification can help to improve the dynamic behaviour of a couple of mating gears, but the amount of correction as to be set on the particular working condition and it is strictly related to the single gear couple and power condition.
- torque inversion can be an origin of high contact force and back side contact, so it is important to calibrate the profile modification.
- backlash can be a parameter that can help modifying the dynamic behaviour of the gear couple, and it is not always true that the backlash reduction can improve the gear behaviour.

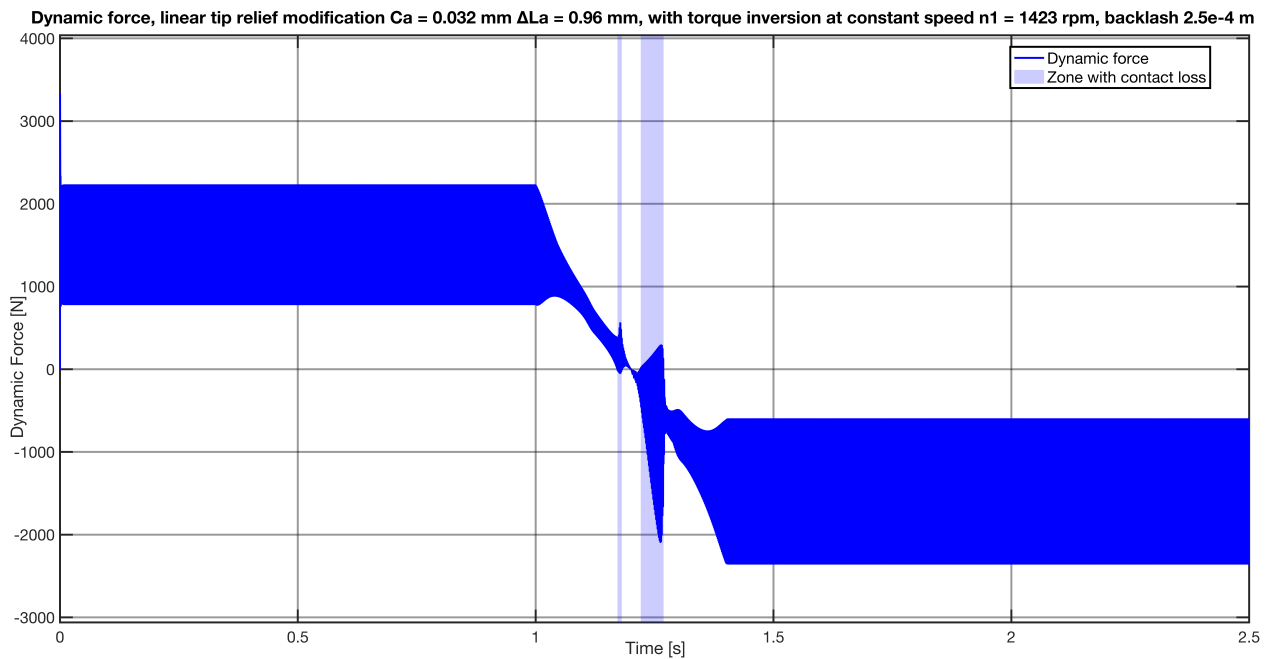

Figure 18. Dynamic force during torque inversion at low speed, n_1 region with profile modification type "a"

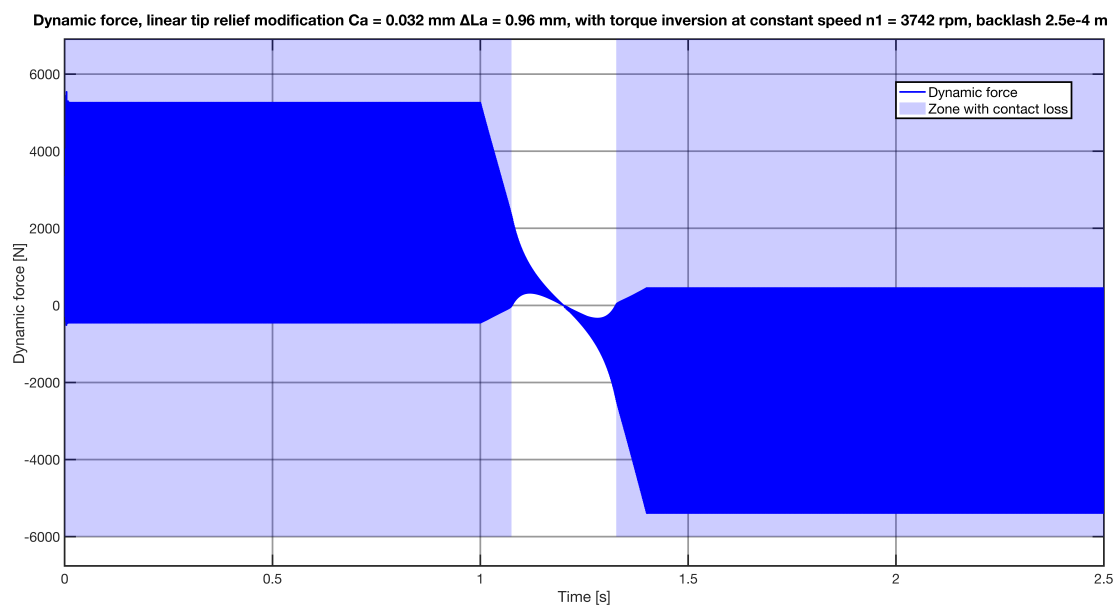

Figure 19. Dynamic force during torque inversion at resonance, n_2 region with profile modification type "a"

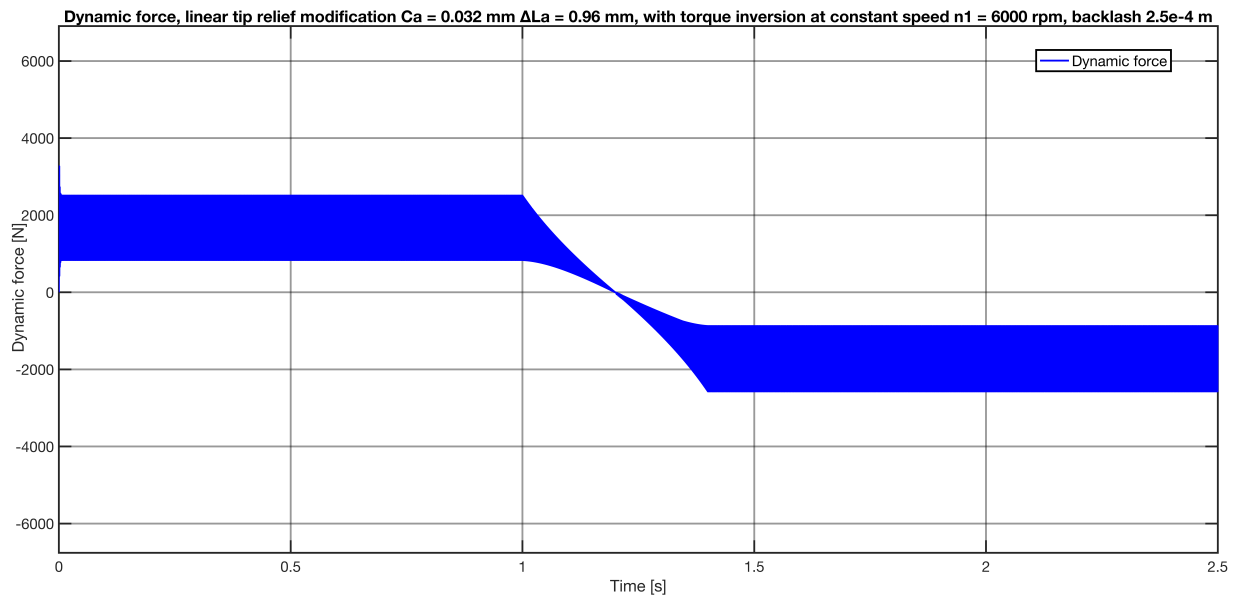

Figure 20. Dynamic force during torque inversion at high speed, n_3 region with profile modification type "a"

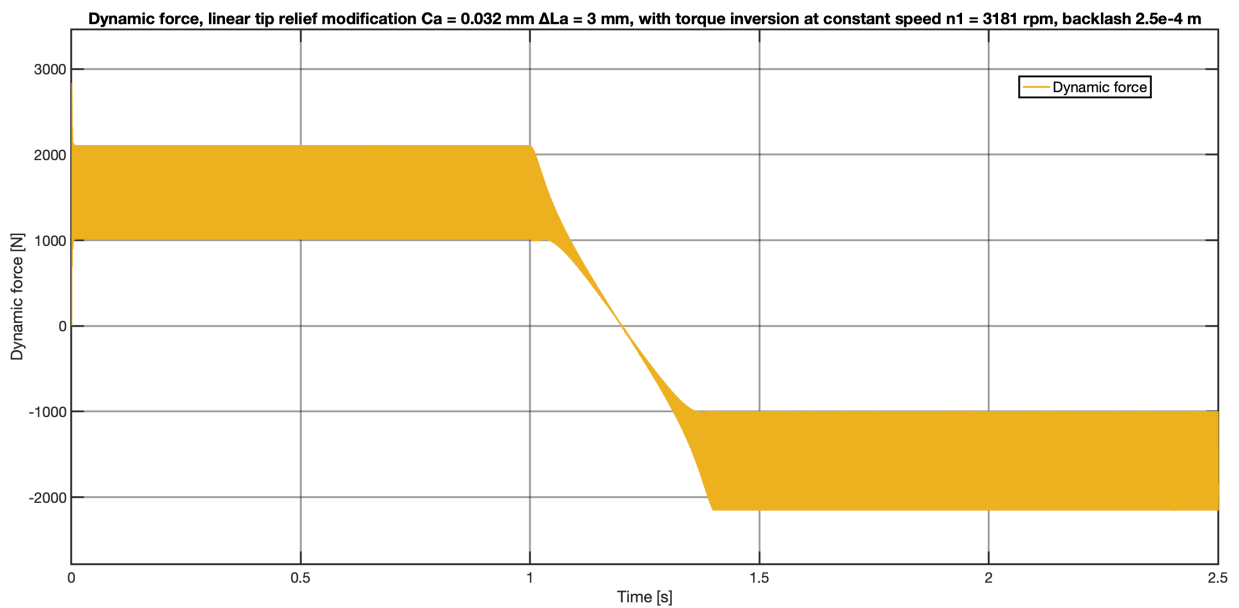

Figure 21. Dynamic force during torque inversion at low speed, n_2 region with profile modification type "b"

References

- [1] Ozguven H N and Houser D R 1988 *Journal of Sound and Vibration* **121**(3) 383–411
- [2] Bruzzone F and Rosso C 2020 *Machines* **8** 37
- [3] Parker R G, Vijayakar S M and Imajo T 2000 *Journal of Sound and Vibration* **237**(3) 435–455
- [4] Eritnel T and Parker R G 2012 *Mechanism and Machine Theory* **56** 28–51
- [5] Dai X, Cooley C G and Parker R G 2018 *Journal of Vibration and Acoustics* **141**(1) (011006)1–13
- [6] Bruzzone F, Maggi T, Marcellini C, Rosso C and Delprete C 2019 *Procedia Structural Integrity* **24** 178–189
- [7] Rosso C, Bruzzone F, Maggi T and Marcellini C 2020 *SAE Technical Paper 2020-01-1323*