

The PLANET Project: A Tool for Flexibility in the Energy Transition

Original

The PLANET Project: A Tool for Flexibility in the Energy Transition / Badami, Marco; Martino, Mariapia; Katsiki, Vasiliki; Kanellos, Konstantinos. - ELETTRONICO. - (2021), pp. 1-58.

Availability:

This version is available at: 11583/2883463 since: 2021-04-05T17:22:05Z

Publisher:

Politecnico di Torino

Published

DOI:

Terms of use:

This article is made available under terms and conditions as specified in the corresponding bibliographic description in the repository

Publisher copyright

(Article begins on next page)



MARCH 2021

WHITE PAPER

The PLANET Project: A Tool for Flexibility in the Energy Transition

TABLE OF CONTENTS

EXECUTIVE SUMMARY	3
KEY RECOMMENDATIONS	6
1. INTRODUCTION	9
1.1 The problem and the need	9
1.2 The PLANET solution	13
2. PILLARS OF THE PLANET FRAMEWORK: NETWORKS, TECHNOLOGIES AND SYSTEM ARCHITECTURE	16
2.1 Electric Grid and DH Networks	16
2.2 Conversion / Storage Technologies (P2X)	20
2.3 The PLANET Decision Support System	25
3. USE CASES AND SIMULATION RESULT ANALYSIS	27
3.1 Exploitation of P2H and DH potential	31
3.2 Exploitation of P2G and NG network potential	35
3.3 Exploitation of VES and buildings potential	38
4. STANDARDIZATION PROPOSALS	43
5. POLICY AND MARKET REFORM PROPOSALS	45
CONTACTS	55
REFERENCES	57

The PLANET Project: A Tool for Flexibility in the Energy Transition

EXECUTIVE SUMMARY

Renewable energy resources offer immense prospects to mitigate greenhouse gas emissions and combat climate change, whilst addressing the growing energy demand. In recent years, owing to falling costs and supportive policies, the integration of renewable energy has expanded significantly. Nevertheless, challenges to its further expansion are raised due to the inherent variability of renewable energy production ('vRES') coupled with grid stability considerations, which - if not properly addressed - shall lead to vRES generation curtailment. The latter would cause renewable capacity expansion to decelerate, reductions in the capacity factors of vRES technologies and subsequent economic losses, to name a few.

Against this backdrop, PLANET has developed a holistic decision support system for utilities, network operators and policy makers to help them implement optimal grid planning and management solutions compatible with complete decarbonization of the energy system. To that end, the project leverages energy conversion and storage technologies, such as Power-to-Gas, Power-to-Heat, Combined Heat and Power, Thermal storages and Virtual Energy Storage. These technologies have been deemed very promising to address issues related to the integration of renewables in the electricity grid, by enabling coordination of the electricity, heat and gas sectors towards revealing the maximum potential of network flexibility, a vital prerequisite for ensuring security of supply.

The PLANET project commenced in November 2017 with the participation of 11 partners from 7 different countries: Italy, Finland, Greece, UK, Germany, France and Belgium including technical universities, research centers and associations, consultancy firms, utilities and information technology companies.

The PLANET Project: A Tool for Flexibility in the Energy Transition

The PLANET project core activities included:

- 1 The modelling of conversion/storage technologies as a means to enable planning, management and operation tools under real deployment in the field. To that end, tools were validated based on field data collected from two different pilot sites, in Italy and France.
- 2 The simulation of the integration between electricity, gas and heat network models, which provided insight into how conversion and storage technologies affect network stability, reliability and responsiveness.
- 3 The development of a holistic decision support system allowing for multi-grid operational planning and management by considering all interactions between the electricity, gas and heat networks.
- 4 Policy and market model impact assessment and exploration, which were utilized for providing proposals and recommendations to policy makers and standardization bodies.
- 5 Exploration and investigation of novel policies and firms' business models that lay the groundwork for unlocking the potential of flexible technologies in the grid.

Thus, with the utilization of the PLANET decision support system, and using real case scenarios, more prospects are generated for the integration of renewables in the electricity grid and the efficient handling of excess energy supply, either to be used, stored or converted into other forms.

The PLANET Project: A Tool for Flexibility in the Energy Transition

This well-planned interplay between electricity, gas and heat, shall allow utilities, operators and policy makers to optimize and verify the balance of the grid significantly enhancing security of supply, assess the techno-economic trade-offs of conversion/storage technologies, explore different scenarios for their systems based on desired characteristics and costs, and last but not least, evaluate the societal impact of conversion/storage technologies in terms of well-being and comfort.

For the successful realization of the energy system decarbonization, investments within the framework of electricity, gas and heat nexus, are vital yet hindered by policy barriers or gaps.

PLANET has identified the main policy categories in need of intervention, which broadly focus on funding/financing instruments/tools and investment costs, DSO regulations, competition between P2X technologies and others, and harmonization of policies for injection of hydrogen into natural gas grids. Ensuring the necessary policy support, will accelerate the wide deployment of conversion/storage technologies. In so doing, the PLANET solution will be a powerful tool in the hands of operators, producers and policy makers to evaluate the necessary technology interventions needed to meet the EU energy transition objectives.

KEY RESULTS AND RECOMMENDATIONS

Important results regarding the flexibility potential used for reducing reverse power flows (RPF) of power-to-heat (P2H), power-to-gas (P2G) and virtual energy storages in buildings (VES)

- The P2H connected to the DH is an effective solution to offer services to the electricity grid: the overproduction of renewable energy can be absorbed and converted as heat. The higher is the DH heat demand, the higher is the flexibility offered by this asset. In the analysed scenario, the RPF has been reduced by almost 80 % during the winter season thanks to this flexible asset. In summer the P2H is not highly relevant for flexibility: the relative low heat demand limits the P2H utilisation. The P2H technology could be a useful source of flexibility both in winter and in summer season if DH and cooling network coexist.
- P2G facilities, have a potential to significantly reduce RFP around the year (i.e., in the analysed use case the RPF is reduced by 95% in winter, by 86% in summer, and by 78% during the rest of the year). The high investment cost of this technology makes its utilisation not profitable from an economic point of view, unless an important incentive policy is undertaken. The economic balance of the plant can be considerably improved by recovering the by-products of the plant (waste heat and oxygen) but this is not sufficient to currently make the plant economically convenient.
- When there is no intervention of district heating and constraints due to gas network (GN), the P2H and P2G operation are similar. However, considering DH and GN constraints, the P2G facilities are able to work more than the P2H assets because the GN can store more RES surplus than DH, especially in summer.
- The asset efficiency plays a very important role for multi-vector energy system operations. Since the efficiency of P2H is higher than the efficiency of P2G, the use of P2H facilities produces greater contributions to economic and environmental goals, even if their use is more intermittent than the use of the P2G facilities.
- The Virtual Energy Storage (VES) in buildings, when operated, can provide a comparable level of flexibility to the system as the other examined technologies at significantly lower investment costs. However, possible needs to avoid RPF outside of this period must be met by other flexibility options which goes along with corresponding investment needs.

The PLANET Project: A Tool for Flexibility in the Energy Transition

As far as the PLANET standardization activities are concerned, a list of standardization punch list achievements can be presented:

Standardization Punch List achievements

- A Preliminary Work Item (PWI) for IEC 61850 model extensions to support thermal energy systems had been set up in cooperation with CRIEPI. This PWI had been accepted by the IEC National Committees and consequently a task force on thermal energy systems (TF 90-27) was established. Its mission is to set up the Technical Report TR 90-27 defining an IEC 61850 information model for thermal energy systems.
- A proposal for considering the use of IEC 61850 for managing gas-based DER connected to electric distribution grids has been sent to IEC National Committees, this proposal will be followed by a PWI for managing gas-based DER.
- The three major PLANET use cases on thermal energy systems are included in the IEC 61850 Technical Report on Thermal Energy Systems (TR 90-27) [1].
- The modelling principles for non-electric DER developed have been included in the IEC 61850-7-420 Edition 2 (CDV) [2].
- The modelling principles for concrete P2H units and CHP, for modelling connections to heat and gas grids and for modelling energy services to the electric grid are incorporated in the IEC 61850 Technical Report on Thermal Energy Systems (TR 90-27).
- TC 57 WG 17 considers the PLANET Information model as an important and relevant contribution for the running work on Thermal Energy Systems and recommends using the PIM for deducting Logical Node Classes and their IEC 61850 data objects for the Technical Report 90-27.
- The data attribute semantics for the PLANET Information Model are enhanced in close cooperation with the TF 90-27 leader. These enhanced semantics along with the corresponding resource models for P2H, VES and CHP are incorporated in the IEC 61850 Technical Report TR 90-27.

The PLANET Project: A Tool for Flexibility in the Energy Transition

While the importance of P2X technologies for the European Union's decarbonisation efforts increases, they still play minor roles in many European energy markets. The PLANET project has analysed existing barriers to P2X investments and made policy/market reform recommendations on this basis.

Key recommendations

- Adopt a mix of policies that is specific to the technology in question and that considers surrounding social and market conditions.
- Allow DSOs to include flexibility options in their business models and unlock the potential of flexible technologies in the grid, without violating unbundling principles. Make use of regulatory sandboxes for ambitious and innovative pilot projects on system integration. Adopt cross-sector development plans.
- Impose or increase taxes or levies on fossil fuels, if currently low levels of such cost components impede the usage of sustainable P2X applications. Alternatively, reduce disproportionately high taxes or levies imposed on electricity used for P2X applications to make them more competitive vis-à-vis the fossil substitutes.
- Reduce investment costs and payback uncertainty for P2X technologies through R&D incentives schemes or investment grants.
- Create comprehensive European and national strategies to unlock the benefits of hydrogen.

In view of the high complexity of energy system integration and its great importance, there is a need to devise long-term strategies for the development of the connected European energy supply systems and the evolution of the industries. For this reason, close cooperation between Member States is crucial for achieving efficient and sustainable results.

1. INTRODUCTION

1.1 The problem and the need

The European Commission (EC) energy roadmap 2050 [3] suggests that by 2050, the European Union (EU) should cut greenhouse gas emissions to 80% below 1990 levels. Although all sectors (power generation, industry, transport, buildings, construction and agriculture) need to contribute to the low-carbon transition according to their technological and economic potential, the power sector has been identified to have the biggest potential for cutting emissions.

The energy system decarbonisation represents a cornerstone of the EU energy policy in the frame of climate change mitigation actions. The Paris Agreement in 2015¹ followed by the “Clean Energy for all Europeans”² legislation package have formalised such a commitment to the transition towards a clean, sustainable and low carbon energy ecosystem. Based on the above pillars of the European energy policy, ETIP SNET has created a roadmap of the transition steps towards a CO₂-neutral, integrated and market-based energy landscape [4].

Energy System Integration constitutes a cornerstone in the “EU Vision 2050” being a necessity in scenarios of massive variable Renewable Energy Sources (vRES) penetration combined with increased electrification of heating and transport sectors. An integrated energy system provides a new holistic perspective for the energy sector that has all of its supply chain components interconnected with horizontal synergies and efficiencies.

As far as the electricity system (EL) is concerned, both generation and demand side are facing the challenge of decarbonisation. At the generation side, the European Commission (EC) has launched a legally binding target for RES coverage up to 32% of the total consumption in the EU by 2030³. With the majority of these sources being variable, a certain amount of intermittency is introduced into the system together with limited predictability and controllability.

¹<https://unfccc.int/process-and-meetings/the-paris-agreement/the-paris-agreement>

²https://ec.europa.eu/energy/topics/energy-strategy/clean-energy-all-europeans_en

³https://ec.europa.eu/clima/policies/strategies/2030_en

The PLANET Project: A Tool for Flexibility in the Energy Transition

Given that their production is not demand, but weather-driven, demand-supply imbalances destabilizes the grid, whose recovery becomes more and more difficult due to lower system inertia caused by the reduction of conventional generating units. At the demand side, the foreseen electrification of heating and transportation sectors is expected to grow in the coming decades, through electric vehicles (EVs) and electric heat pumps (HPs) [5]. This will increase the total energy consumption and generate demand peaks, depending on driving and heating patterns, both of which will have significant impact on the system stability and the security of supply. Therefore, there is a need to unleash the flexibility embedded in distributed energy resources and exploit it for supporting the new responsibilities of active network management that will arise for the future DSO-e.

The natural gas network (NG) is also facing challenges with the energy system restructuring and the paradigm shift towards distributed generation. Until now, the traditional link to the electricity system has been established through the gas-fired power plants operating with Open or Combined Cycle Gas Turbines (OCGT or CCGT).

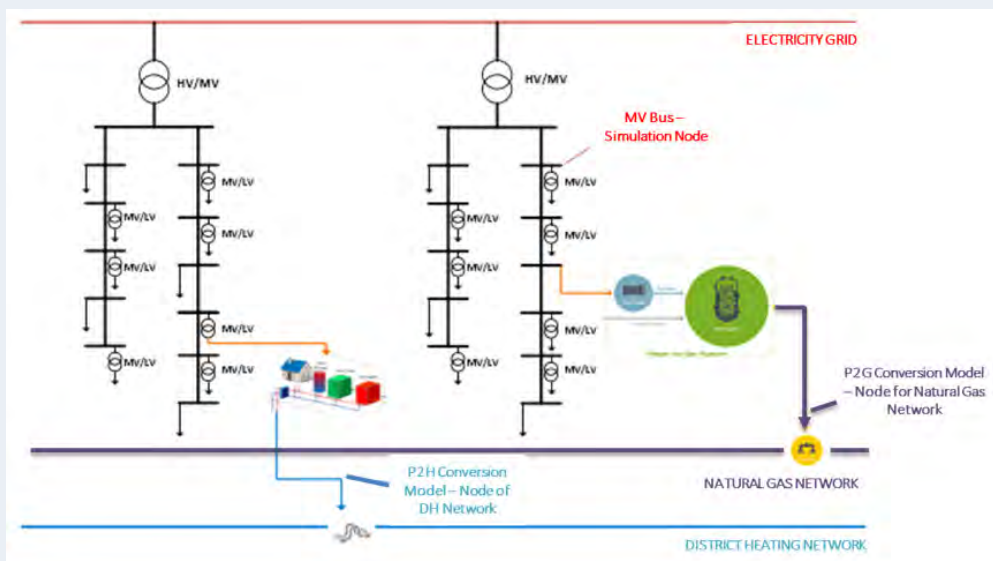

Figure 1: Scope of energy networks and bridging conversion technologies in PLANET project

The PLANET Project: A Tool for Flexibility in the Energy Transition

Through the introduction of variable renewable energy sources in the electricity system (vRES-e) (e.g., PV, Wind, etc.) together with increase of resource substitutability of the energy needs (e.g., end-user can alter electric heating and gas heating), a variability is also directly introduced as intermittency in the gas demand as well and influences the Linepack management (linepack refers to the total volume of gas within the system) [6]. In parallel, the interconnection of the electricity and gas networks is currently being enriched with the introduction of power-to-gas (P2G) transformations through innovative technologies (e.g., electrically-driven compressors as well as stand-alone power-to-hydrogen/methane conversion units). Hence, the need for an integrated approach based on network coordination and co-optimisation through cross-carrier flexibility services emerges and appears to be a technological viable solution for the future energy challenges.

The envisaged carbon-neutral energy with high shares of intermittent renewable generation affects the District Heating network (DH) as well. The introduction of large-scale heat pumps (HPs) that directly couple the electrical with the district heating systems through power-to-heat (P2H) energy conversion changes the traditional configuration of gas-fired boilers and co-generation. However, due to the cost-effectiveness of the latter, an HP-based DH network is not an economically optimal solution. The business case viability of an HP-based DH network can be further enhanced through the quantification and optimization of its flexibility. Hence, there is a need to coordinate the P2H with vRES peak production in order to create a value proposition based on parallel service offerings and combination with demand response techniques.

Without the option of on-grid storage/conversion units and flexibility exploitation, the option of vRES generation curtailment is the only available in the event of an electrical demand-supply mismatch. It has been estimated that circa 30 TWh of vRES-e will be curtailed per year by 2030 and more than 200 TWh/year by 2050 [7] taking into account renewable growth and traditional energy system constraints. In a scenario of full electrification of heating, the combined GHG emissions of heat and power sector could decrease by 16% and the curtailed renewable energy by 17% [8].

The PLANET Project: A Tool for Flexibility in the Energy Transition

However, the time shift between the renewable production and the electricity demand patterns as well as demand variation between the summer and winter seasons is likely to lead to congestion issues and jeopardize power delivery in terms of quality and reliability. In order to address these challenges and effectively maximize the integration of renewables, there are basically three potential solutions:

Grid Infrastructure Upgrade

By establishing new power lines and enhancing existing ones, excess electrical energy can be transported from the centers of generation to the centers of demand avoiding bottlenecks.

Flexibility Aggregation & Exploitation

There are decentralized energy resources (DER) that can provide useful power flexibility in order to bridge demand and supply unequal distribution. Such flexibility assets can be storage technologies (e.g., grid connected electrochemical batteries, EVs, etc.), dispatchable power generators (e.g., CHP, etc.) as well as active demand (e.g., IoT-enabled controllable loads, etc.). The electrical response of such assets can be impactful on district-level when aggregated and optimized.

Conversion (P2X) Technologies in an Integrated Energy System

The current modus operandi of the decoupled electricity/gas/heating networks must be changed in order to allow synergies between the energy networks. Excess electrical energy can be converted into gas or heat in order to be used in a multi-purpose manner, to be stored in the respective networks, or even be reconverted in electric energy after some time.

The PLANET Project: A Tool for Flexibility in the Energy Transition

1.2 The PLANET solution

PLANET framework has been developed upon two research innovation fields, namely the energy system integration and the distribution network active management. It focused on network coupling at the level of distribution among Electricity, Heat and Gas sectors in an attempt to identify value chains in the cross-section of these two domains. PLANET is a holistic optimization framework based on an integrated approach for short and mid-term energy grid planning. It facilitates the bridging of the three energy carriers, namely electricity, natural gas, and district heating, a broad portfolio of decentralized storage/conversion solutions capable of providing different grid services [9]. This solution aspires to contribute to the full integration of clean renewable energy resources by exploiting the potential of interconnections and synergies between different energy networks and by increasing the flexibility of electricity demand. Figure 2 summarizes the project objectives, the scope of DER technologies and networks simulated as well as the major stakeholders that the solution targets or the project has involved.

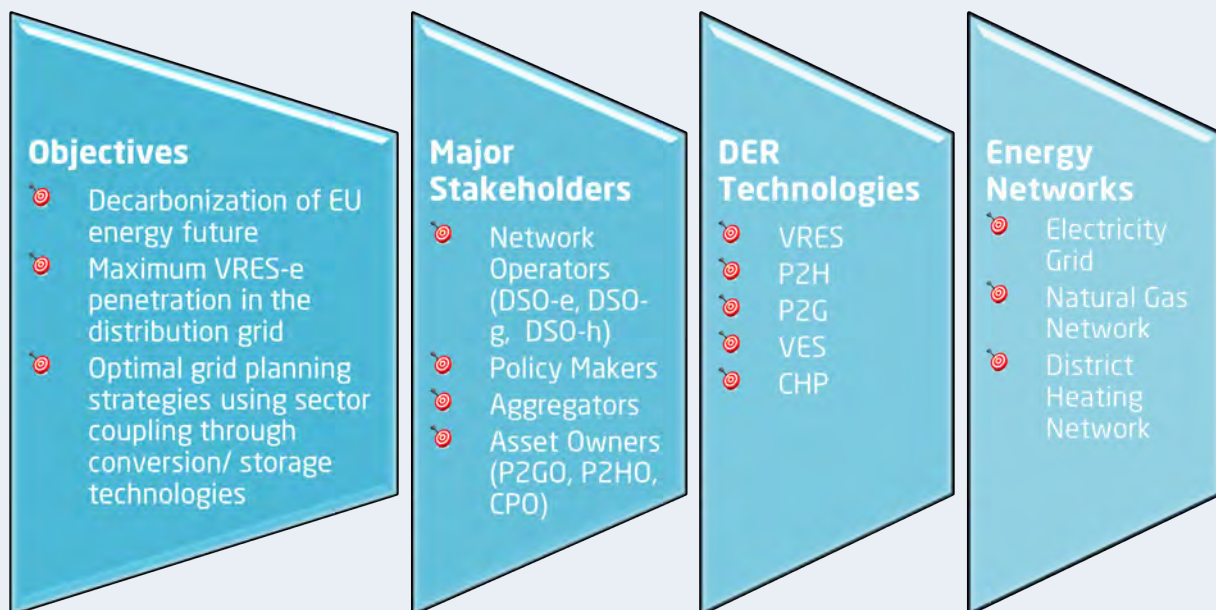

Figure 2: PLANET in a nutshell [9]

The PLANET Project: A Tool for Flexibility in the Energy Transition

The PLANET solution followed three core activity lines:

1 The modelling and simulation of all three distribution grids (EL, DH, NG) and interconnected resources including energy generation, demand, storage and conversion.

2 The development of a Decision Support System (DSS) that enables multi-grid operational planning and synergies management taking into account energy flows and network boundary conditions.

3 Policy and market model impact assessment and exploration through a validation framework that started from use case definition, extraction of simulation scenarios, validation through PLANET DSS and extraction of data-driven conclusions in order to propose new policies and ad-hoc standardization applications.

PLANET DSS has been created upon a district-level perspective including simulation models of the electric grid, the gas network and the district heating (DH) network along with interconnected renewable generation and demand profiles. Furthermore, it includes configurable distributed resource models of Power-to-Heat (P2H), Power-to-Gas (P2G), Combined Heat and Power (CHP) conversion technologies and Virtual Energy Storage (VES). An energy flow optimization and storage/ conversion unit coordination engine (SCCE) calculates optimal power setpoints for each resource. On top of the unified simulation-optimization layer, a Decision Support System (DSS) allows the configuration of different scenarios and boundary constraints of real deployments outlined in the future energy system scenarios.

The PLANET Project: A Tool for Flexibility in the Energy Transition

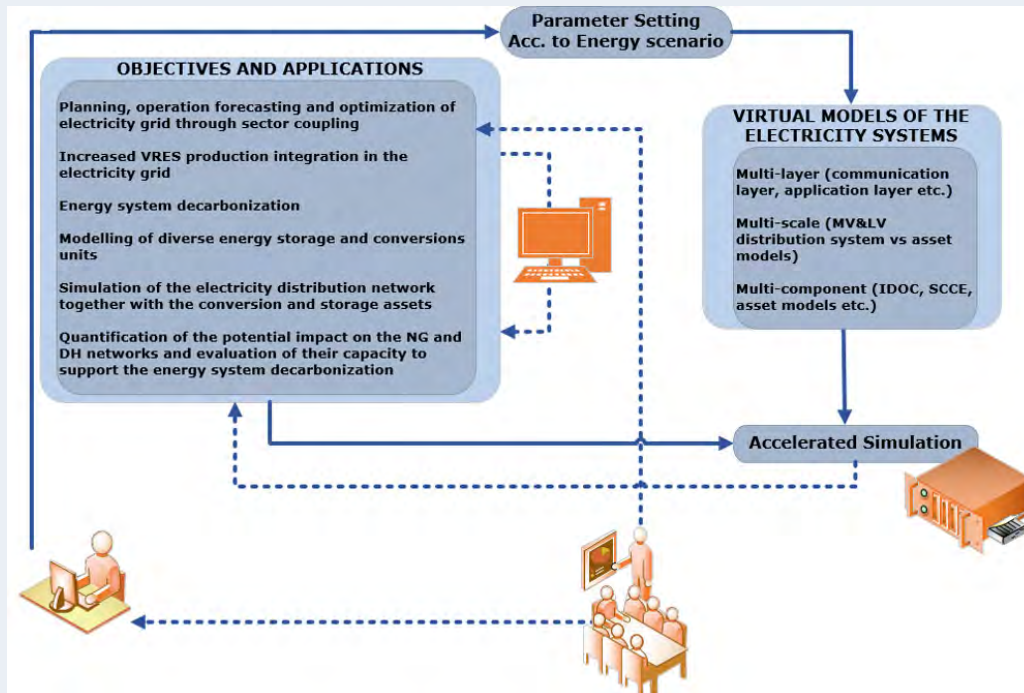

Figure 3: Planet DSS concept of operation [10]

2. PILLARS OF THE PLANET FRAMEWORK: NETWORKS, TECHNOLOGIES AND SYSTEM ARCHITECTURE

2.1 Electric Grid and DH Networks

Electric Grid

The electrical grid is based on a portion of urban distribution grid of Turin (a city in north-western Italy). The network topology, shown in Figure 4, comprises five feeders, derived from a primary substation (operated at 220 kV) via three HV/MV transformers. Two of the transformers have nominal power of 63 MVA while the third one of 55 MVA. The MV network is radial, operated at 22 kV/50 Hz and includes 43 MV/LV substations (i.e., the network buses).

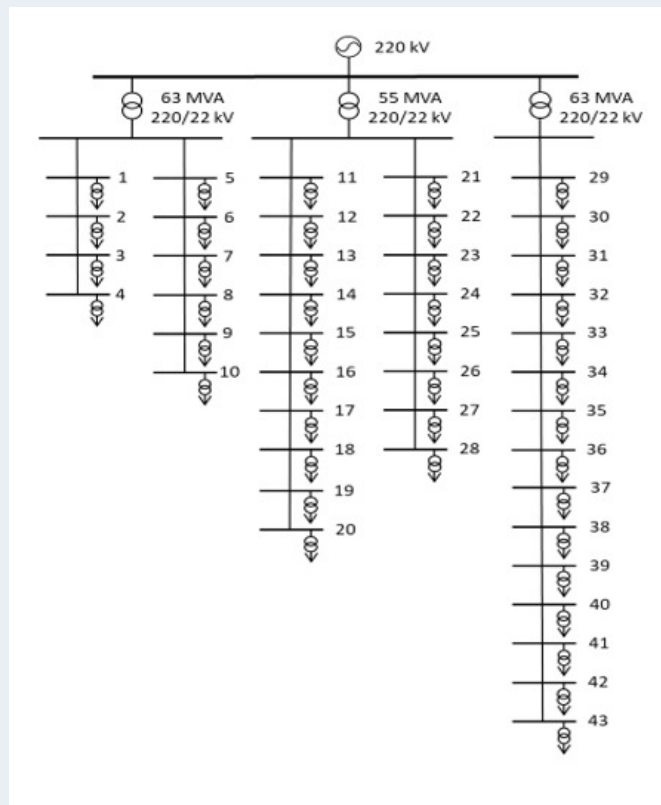

Figure 4: Grid topology used in PLANET

The PLANET Project: A Tool for Flexibility in the Energy Transition

The PLANET simulation engine allows multiple configuration options enabling customisation of the network to different topologies, line parameters, implementation of both underground and overhead lines. The engine development is based on Simulink environment and adapted to be suitable for running in real-time through a Real Time Simulator (RTS). The network simulation comprises three different modes:

Initialization mode

The network model is configured through user inputs (e.g., RES, load profiles, and line parameters such as length, resistance, inductance and maximum current).

Simulation mode

The calculations are coordinated and synchronised with all the output energy resource modules under an innovative co-simulation framework.

Evaluation Mode

Calculation of KPI for simulation result assessment:

- ✓ Grid losses [kWh]
- ✓ Percentage grid losses [%]
- ✓ Reverse power flow [MWh]
- ✓ Grid self-sufficiency [%]
- ✓ Grid self-consumption [%]
- ✓ Voltage pattern [p.u.]
- ✓ Lines loading factor [A]
- ✓ Grid Power [MW]

The PLANET Project: A Tool for Flexibility in the Energy Transition

District Heating

The district heating network model is based on an original approach that can be adapted to any network size. The main idea is that large networks can be decomposed in two parts, namely transportation and distribution.

The transport network is the main network, connecting the thermal plants to the various areas of the city. The transport network of the Turin district heating system is shown in Figure 5-left. The presence of various loops allows quite flexible operation of the network and reduce the impact of possible failures. The distribution networks connect the transport network to the various buildings in a specific area. An example is shown in Figure 5-right.



Figure 5: Transport network and distribution network

This type of modelling is typically applied to link the thermal demand of the buildings to the load profile of the plants.

The PLANET Project: A Tool for Flexibility in the Energy Transition

The model allows to analyse possible actions operated on the building side (e.g. demand-side management, use of distributed storage, etc.), on the network side (e.g. pumping optimization, variation in the supply temperature, etc.), or on the plant side (e.g. power-to-heat, use of centralized storage, etc.). This approach allows the adoption of a modelling strategy able to consider the network topology without requiring heavy computational efforts.

Fluid dynamics and thermal behaviour of the network are also considered. An approach that solves the fluid flow in a single step is integrated in order to avoid computational complexity due to iterative calculations of non-linear forms at each time-step. This is achieved through subtracting one branch per loop in the network, the mass flow rate of which is imposed by means of a data driven model expressed as the function of the mass flow rate exiting each plant [11].

For the thermal problem solution in each distribution network, a clustering approach is adopted in order to obtain a surrogate model. This transforms the original network into a proper number of parallel pipes connecting the transport network to a cluster of buildings. The configuration parameters of this equivalent network are: (1) the number of parallel pipes; (2) the length of each pipe; (3) the diameter of each pipe. These parameters as well as the cluster of buildings are determined by means of an optimization procedure in which a transient evolution of the thermal load profile at the inlet node (the connection of the network to the transport network) is considered. In the optimization process, the deviation between the evolution obtained with the reduced model and that obtained with the full model is minimized. In the case of the transport network, the complete energy equation is solved [12].

2.2 Conversion/ Storage Technologies (P2X)

Power to Gas

The P2G plant model comprises the following blocks:

- Electrolyser unit: PEM technology to enable fast dynamic response
- Hydrogen buffer
- Methanation unit: Catalytic Methanation

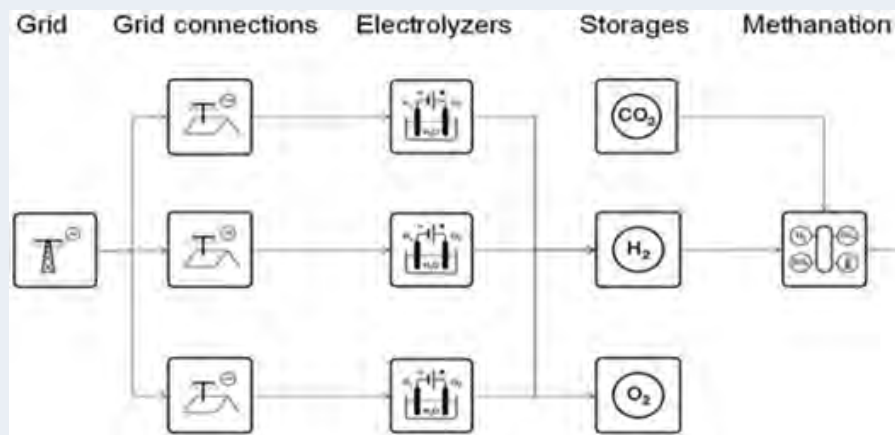

Figure 6: Power-to-gas (P2G) conversion concept[13]

The outputs of the module are the electric power, the CO₂ consumption, the Synthetic Natural Gas (SNG) production and the derivative process heat.

Focusing on the electric power response, the module provides the P2G flexibility forecast consisting of three timeseries:

> **Baseline load**

Refers to the amount of electric energy that the plant should be scheduled to absorb under normal conditions.

The PLANET Project: A Tool for Flexibility in the Energy Transition

➤ Upwards flexibility

Refers to the maximum electric energy that is able to be absorbed.

➤ Downwards flexibility

Refers to the minimum electric energy that will be essentially absorbed.

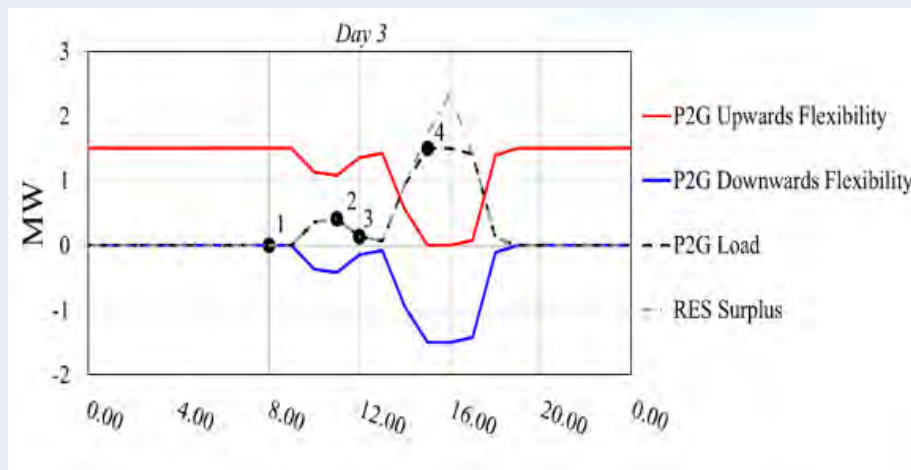

Figure 7: Electrical Response Timeseries

The model considers scales from 1 to 20 MW plant, typically 5 MW, which are suitable for interconnection in the MV grid. Such a plant requires fast ramping capabilities to meet fluctuations of local renewable power and local balancing needs, as well as a very compact concept to keep capital expenses (CAPEX) at low levels. To this end, the hydrogen compressor systems are replaced by the hydrogen buffer between the electrolyzer step and the methanation step.

The PEM electrolyzer submodel is a fully integrated turn-key PEM electrolyser system including water purification, hydrogen purification, control systems and temperature management equipment.

The PLANET Project: A Tool for Flexibility in the Energy Transition

The methanation unit submodel consists of a catalytic methanation reactor model, which has been calibrated to data from detailed first principles models. The size of the methanation unit is automatically set to match the electrolyzer size and its nominal hydrogen mass flow output with an additional 10% overproduction margin to enhance flexibility in operation. The methanation plant model itself consists of surrogate models that have been generated for start-up, dynamic transient around nominal state and shutdown periods of the catalytic methanation process.

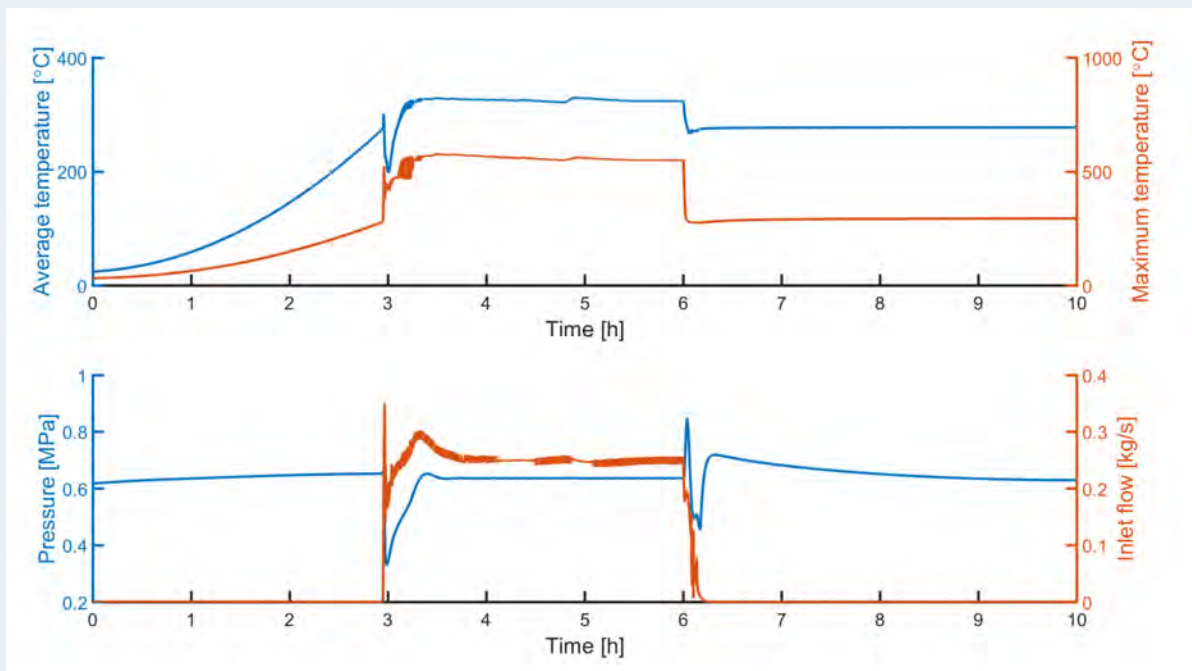

Figure 8: Behaviour of methanation reactor in P2G plant start-up, pressure and temperature fluctuations [14]

In the Planet P2G configuration, the hydrogen feed into the methanation reactor is optimally controlled according to the state of the methanation reactor, the electrolyzer hydrogen production and the pressure in the buffer storage.

Power to Heat and storage in DH

Thermal storage is used in district heating systems in order to increase the utilization of heat available from efficient and/or renewable sources, such as waste heat, cogeneration, power-to-heat technologies, etc.

The PLANET Project: A Tool for Flexibility in the Energy Transition

The main idea is to store heat when the demand is low and use it when the demand is peaking. Thermal storage is achieved either through central or distributed storage units. In the case of central storage, water is typically used as a storage medium. The modelling approach adopted constitutes the one-dimensional form of the energy equation with the thermal conductivity of water modified in order to account for the turbulent phenomena occurring in the tank [15].

Concerning distributed storage units, these can be stratified systems as well but their energy density is quite small, due to the small temperature differences that are typically adopted in the heating systems of the buildings (5-10 °C). In the PLANET context, the temperature difference between fully charged and fully discharged unit can be of the order to 50-55°C, which is the case of Turin (Italy) district heating. The corresponding energy density is of the order to 220 MJ/m³, when water is considered as the medium. When installations in buildings are considered the energy density of water-based systems is of the order of 50 MJ/m³.

Virtual Energy Storage

Building-level Virtual Energy Storage (VES) constitutes an important technique in the frame of demand-side management. It unleashes demand flexibility potential based on a combination of contextual parameters, such as space dynamics, usage patterns, etc. Within PLANET, a local P2H-enabled VES module produces building-level demand flexibility profiles for a set of predefined time parameters (e.g. horizon, granularity) and aggregates them in order to estimate the demand flexibility potential on MV/LV node-level in the electrical distribution grid. Through this district-level upscaling, the demand flexibility can be considered in power flow analysis and optimization becoming a valuable tool for the grid planner in order to manage congestion and local network constraints verification. This is actually the core role of VES within PLANET system, which provides a holistic network simulation and asset coordination platform for a portion of the distribution network.

VES module comprises two main sub-models under a unified optimization framework, namely the space thermal and the user comfort model.

The PLANET Project: A Tool for Flexibility in the Energy Transition

The former represents the building envelope through its 2nd order electrical analogue and models the thermal dynamics of the different space elements (e.g., indoor ambience, surrounding walls, etc.) through different resistances and capacitances. The Resistance-Capacitance (RC) models are configurable and their configuration parameters are identified on the basis of data streams retrieved and pre-processed from smart gateways of Wireless Sensor Network (WSN) installations. Figure 9 shows representative temperature profiles that are produced by the space thermal model both in the training/ calibration procedure and in the “normal” operation as forecasts.

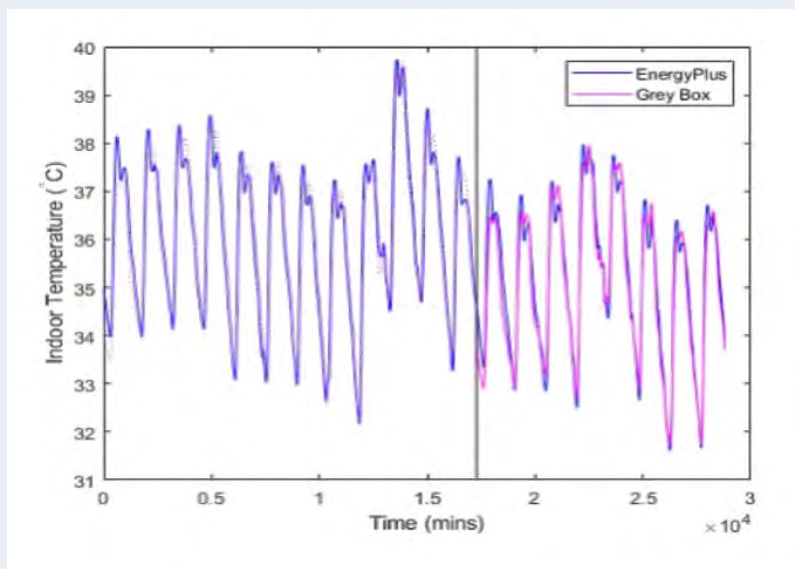

Figure 9: Temperature profiles for a space of indicative commercial building

The user comfort model configures “thermal comfort” profiles that are introduced into the flexibility optimization as upper and lower temperature boundaries that can be tolerated in a space by its users. The inference of this thermal comfort zone is realized through a supervised Machine Learning (ML) algorithm that uses prior knowledge of control commands on LP2H units (e.g., temperature setpoints, ON/OFF, etc.) combined with simultaneous ambient conditions.

The PLANET Project: A Tool for Flexibility in the Energy Transition

The two stochastic sub-models described are integrated under a horizontal optimisation framework that provides the forecasted flexibility profiles as a set of timeseries presenting the maximum energy that can be consumed per timestep (upwards flexibility) and the minimum one (downwards flexibility) with respect to a baseline consumption. The flexibility profiles extracted per building are further aggregated on district-level creating upwards and downwards demand flexibility profiles per MV/LV node. The sum flexibility forecast is used as input for grid power flow optimisation, which produces the optimal demand modification.

2.3 The PLANET Decision Support System

The PLANET Decision Support System [16] incorporates “know-how” of actual energy networks, storage/conversion assets, technical constraints and specifications from different scientific fields, energy-information-control flows and ICT techniques. It combines several back-end modules, which are orchestrated under an innovative co-simulation framework, with a user-friendly graphical user interface that facilitates scenario configuration and result presentation.

A main functionality of the PLANET platform is the scenario creation and management, namely the configuration of energy networks and interconnected energy resources as well as the definition of time parameters of the existing or future energy scenario to be investigated.

A second functionality is the flexibility unit registration and management which enables both creation of dummy/virtual flexible assets and actual energy conversion plants. The former facilitates network planning and “what-if” analysis from a single-user perspective, which could be a system operator or a policy maker, and the latter offers the opportunity of multiple-user access though distinct dedicated interfaces for day-ahead operational planning.

After the scenario simulation and optimization session is concluded, a set of applicable key performance indicators (KPIs) is calculated in order to quantify the effectiveness of system planning. The pool of metrics is wide and allows a multi-level impact assessment namely technical, economic and environmental in all three energy Vectors (EL, NG, DH).

The PLANET Project: A Tool for Flexibility in the Energy Transition

The visualization of the processed results and the quantified conclusions is realized via a Visual Analytics component so that the overall efficiency of cross-sector synergies can be presented in a concise and user-friendly manner.

The infographic of Figure 10 summarizes the different capabilities of the PLANET ICT platform.

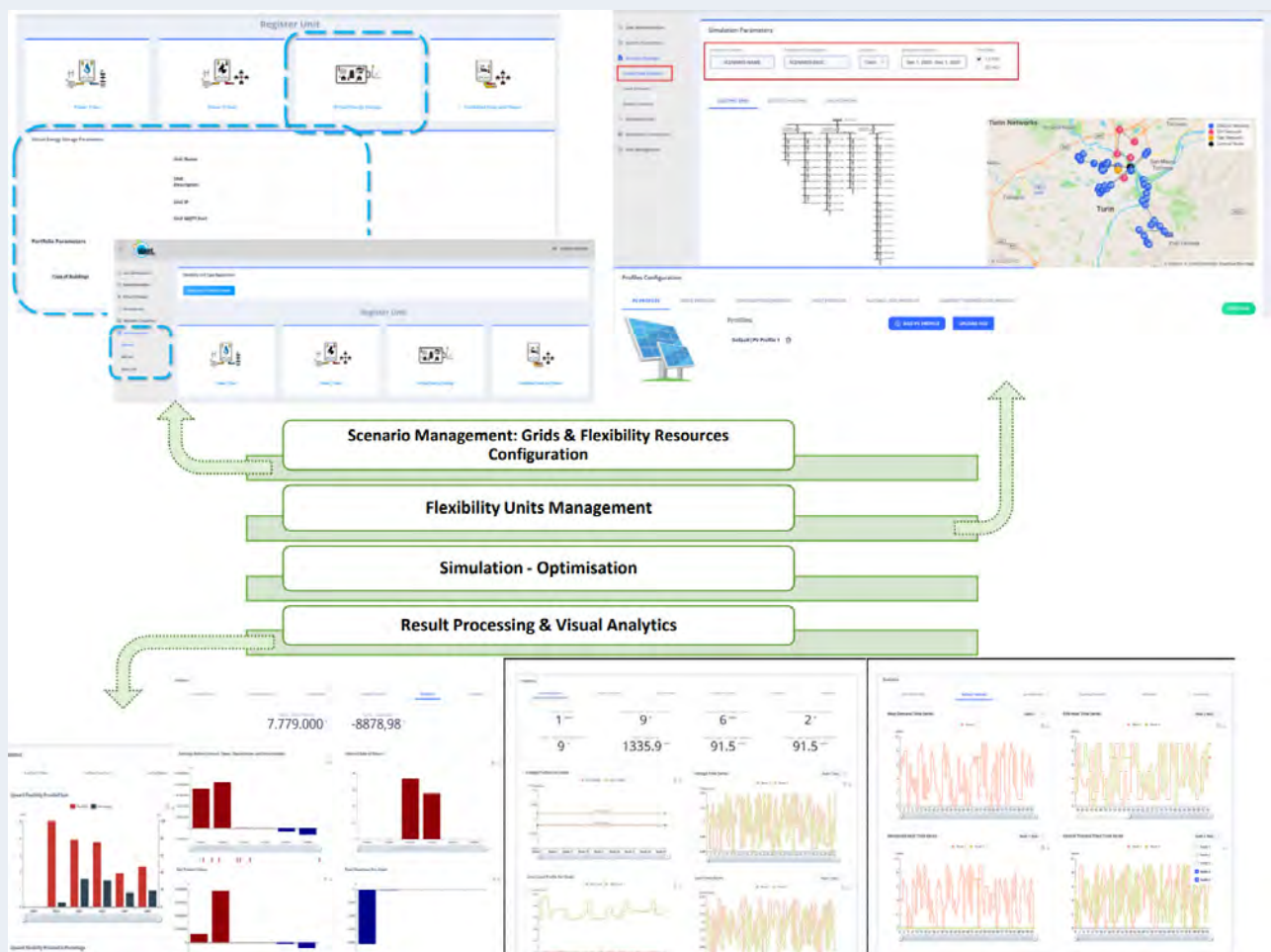

Figure 10: PLANET DSS functionalities and views

3. USE CASES AND SIMULATION RESULT ANALYSIS

The scope of validation activities, the simulation testbed and the system requirements of PLANET framework constitute results of an elaborate use case definition and grid interface specification [17] [18]. A diverse set of simulations have been carried out covering different time horizons (i.e., daily simulations, annual simulations, etc.). Some of the most important aspects investigated involve Power-to-Gas deployment for electrical distribution system control, Virtual Energy Storage in buildings for flexibility profiling and energy demand shifting, centralized thermal storage through heat-pumps in District Heating facilities.

Power-to-gas deployment for system control

Electrical distribution system control has been investigated in terms of network congestion management, voltage limits violations and reverse power flow. The deployment of distributed P2G conversion resources introduces the essential flexibility that PLANET system optimally allocates in order to effectively modulate local demand and reduce the imbalance with vRES local generation.

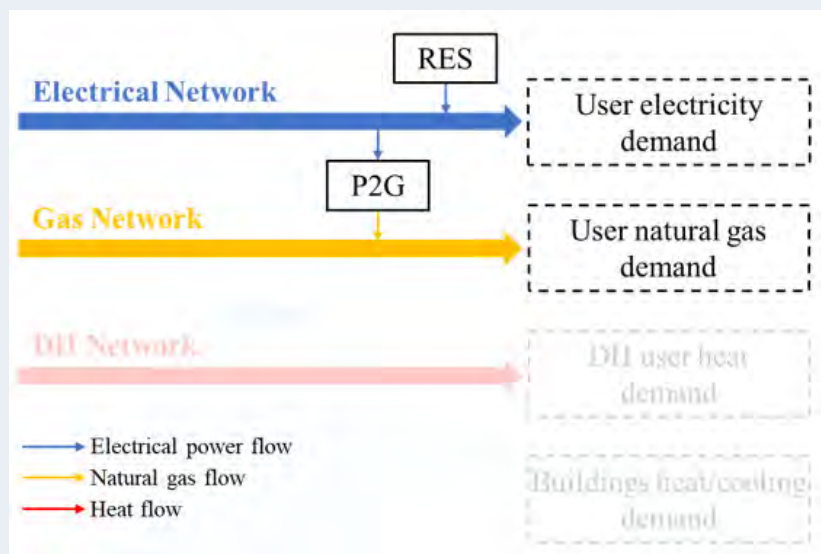

Figure 11: Network scope of the use case

The PLANET Project: A Tool for Flexibility in the Energy Transition

The optimal deployment of the P2G units is crucial as it directly affects the power flows among the local resources and therefore potential line overutilization and node voltage deviations.

Beyond electrical distribution system parameters, the P2G conversion modules are also destined to hedge uncontrolled feeding of the excess vRES generation to the transmission system. A generic rule for optimal siting in such a case would be the placement of the conversion units close to an HV/MV substation but this is a rather complex optimisation issue that should be examined per case.

Virtual Energy Storage in buildings for flexibility profiling and energy demand shifting

This use case deals with the experimentation of an advanced management of the electrical end-user demand for heating purposes and domestic hot water provision, providing a possible benefit for system operation. In this use case, the present electrical consumption of the building will be analysed, assessing some possible future scenarios of consumption and evaluating electricity demand shifting. The flexibility extraction will be comfort-preserving and thus it will be assured that this advanced network management will be seamless.



Reverse Power Flow (RPF)

1. Its presence is quite annoying for the distribution system as it affects the proper operation of the protection system and may also complicate the voltage control.
2. If the RES is high in multiple MV feeders, the RPF cannot be redistributed among them and thus is injected into the HV transmission system. This is a liability for the Transmission System Operator (TSO), which has to handle a quite irregular injection of power that cannot be properly controlled.

The use case validates the building attributes of virtual energy storage. This use case also investigates the indirect synergy between the electrical and gas distribution networks exploiting the building as a bridge between the grids due to the substitutability of the energy resources that can cover the heating demand.

The PLANET Project: A Tool for Flexibility in the Energy Transition

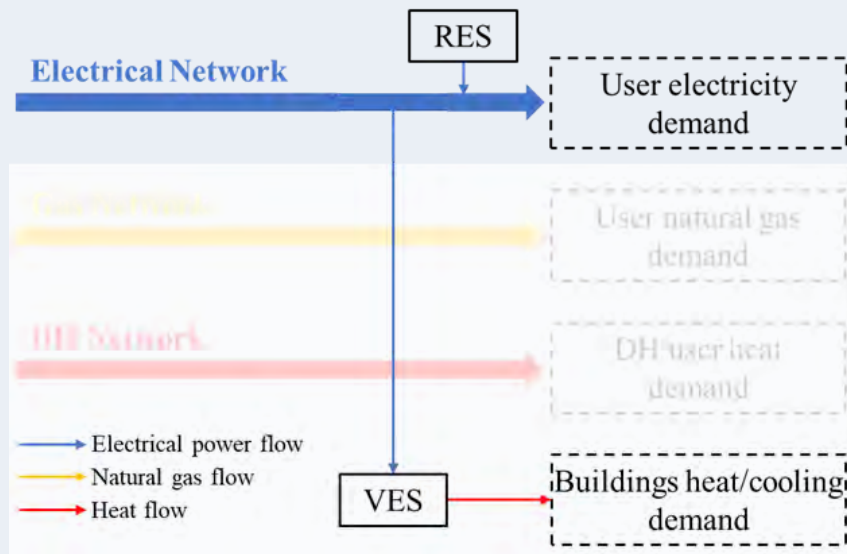

Figure 12: Network scope of the use case

Centralised heat-pumps for hot water storage in DH plant facilities

This use case deals with the experimentation of an advanced application of centralized heat pumps connected to existing power plants and/or distributed heat pumps to use these devices to handle the renewable energy production, by then offering balancing services to the grid. The application of this scenario will show also the possibility to exploit the devices for feeding the actual district heating network and/or new extensions of this network, supported by thermal heating storages.

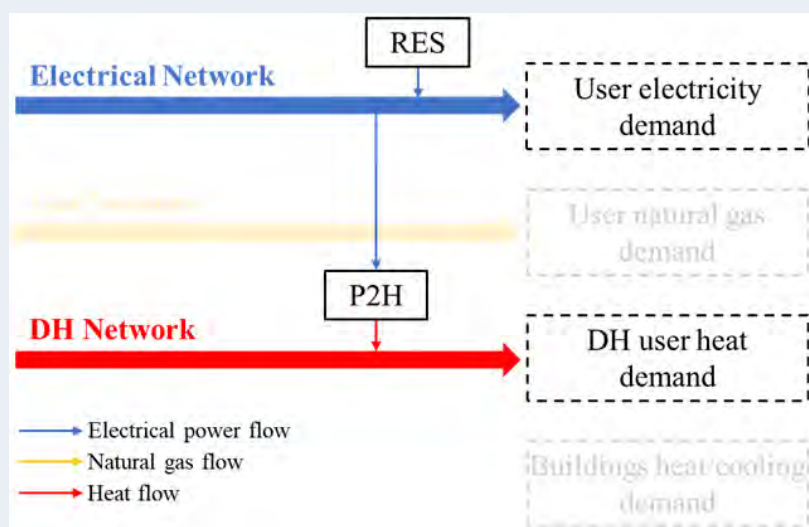

Figure 13: Network scope of the use case

The PLANET Project: A Tool for Flexibility in the Energy Transition

PLANET Simulation and validation testbed

The electrical grid topology utilised for the validation of P2H and P2G scenarios is reported in Figure 14. While it is structurally representative of a section of Turin electrical distribution network, the distributed generation resources correspond to a future energy scenario with high shares of vRES penetration. The total passive load installed power is 35.66 MW, divided among different types of users, namely residential, industrial, commercial and offices. The grid includes both wind and photovoltaic (PV), with a total RES installed power equal to 31.22 MW. This scenario is used as a baseline reference for network coupling potential.

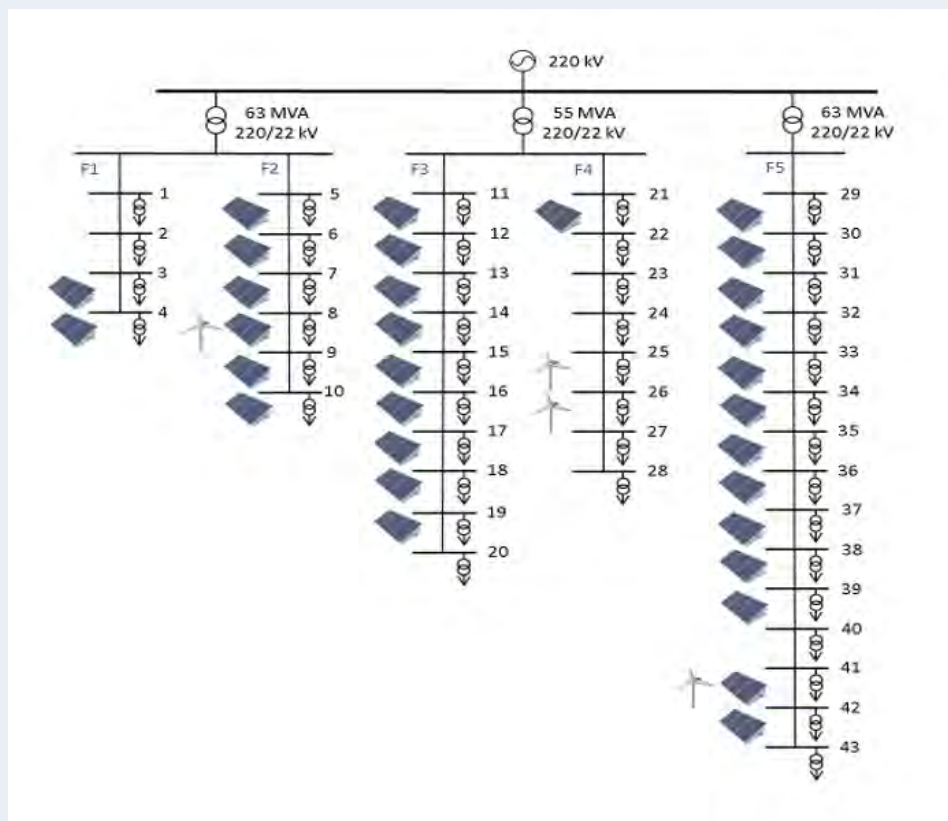

Figure 14: The electrical grid topology

3.1 Exploitation of P2H and DH potential

Figure 15 shows the coupling topology of the Electrical grid (EL) and District Heating (DH) linked through centralized P2H facilities. The DH network is represented with a radial structure and is composed of five thermal nodes, of which only three, in the current case study, are supplied by P2H facilities. The characteristics of the P2H facilities are shown in Table 1.

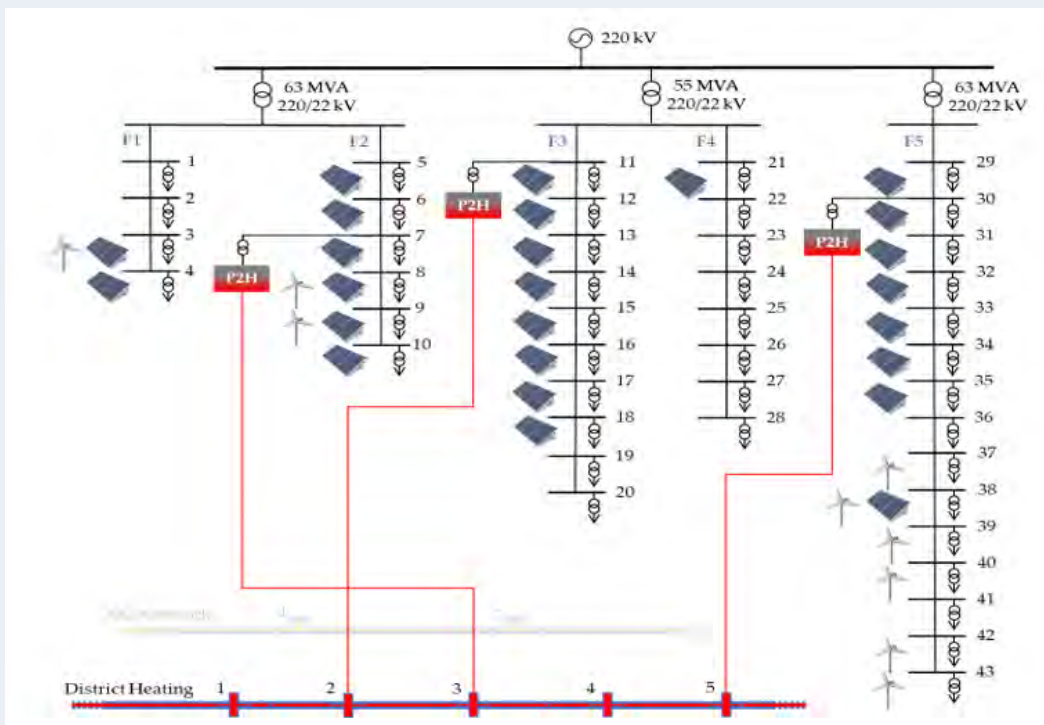

Figure 15: Case study topology: DH, P2H and electrical grid

Asset	EL Node	DH Node	Nominal power
$P2H_1$	7 (Feeder 2)	3	5 MW _{th}
$P2H_2$	11 (Feeder 3)	2	2 MW _{th}
$P2H_3$	30 (Feeder 5)	5	10 MW _{th}

Table 1: Allocation and nominal power of P2H systems

The PLANET Project: A Tool for Flexibility in the Energy Transition

As shown in Figure 16, the reverse power flow (RPF) injected into the transmission system in a benchmark winter day is eliminated whereas in a benchmark summer day it cannot be reduced in the same manner. Such behaviour is related to limitations imposed by the DH: the heat demand is relatively low in summer while it is higher in winter. The presence of RPF and the potential of the P2H connected to the DH are shifted in time and this does not allow to a proper match of the need, namely RPF reduction, with the means, P2H facility utilisation.

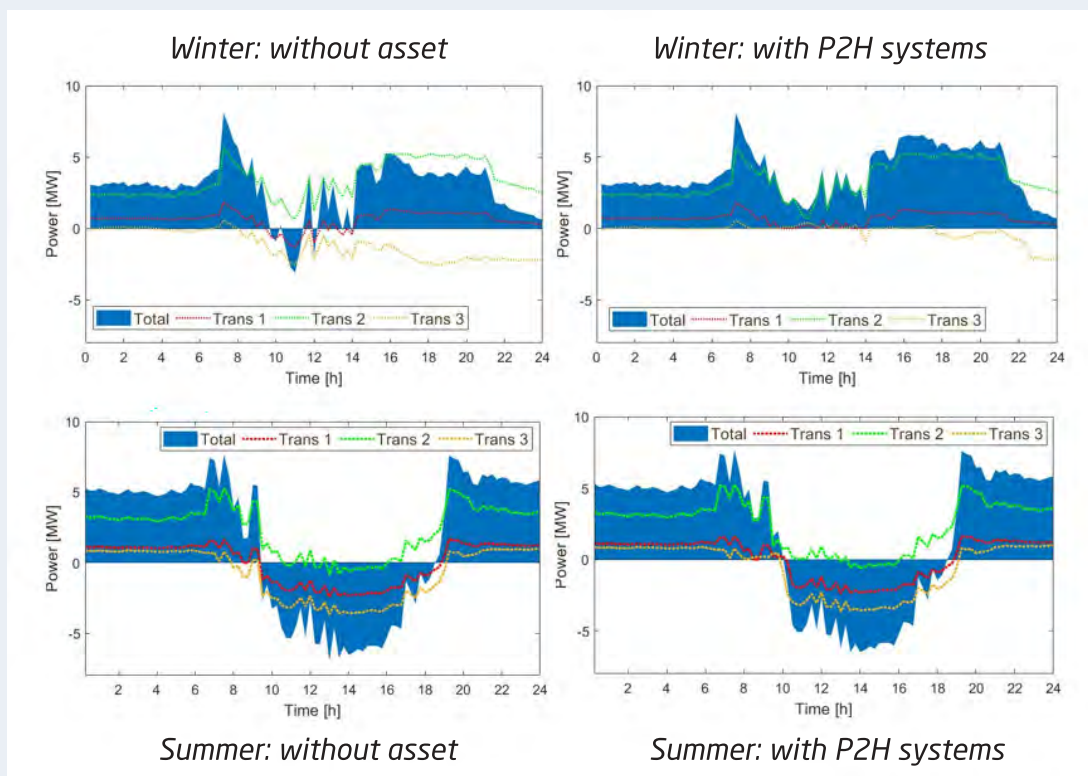

Figure 16: Power flow, considering all the transformers and the overall grid

As shown in Figure 17, the reduction in the RPF is due to the increase of the thermal load through extensive P2H utilisation. In any case, RPF still exists in the EL-DH coupled scenario because of the intermittent wind production. In the graphs that present the DH dynamics, thermal storage plays a crucial role in the time shifting of vRES production and heat consumption, since both the P2H and the centralized heat production contribute to it.

The PLANET Project: A Tool for Flexibility in the Energy Transition

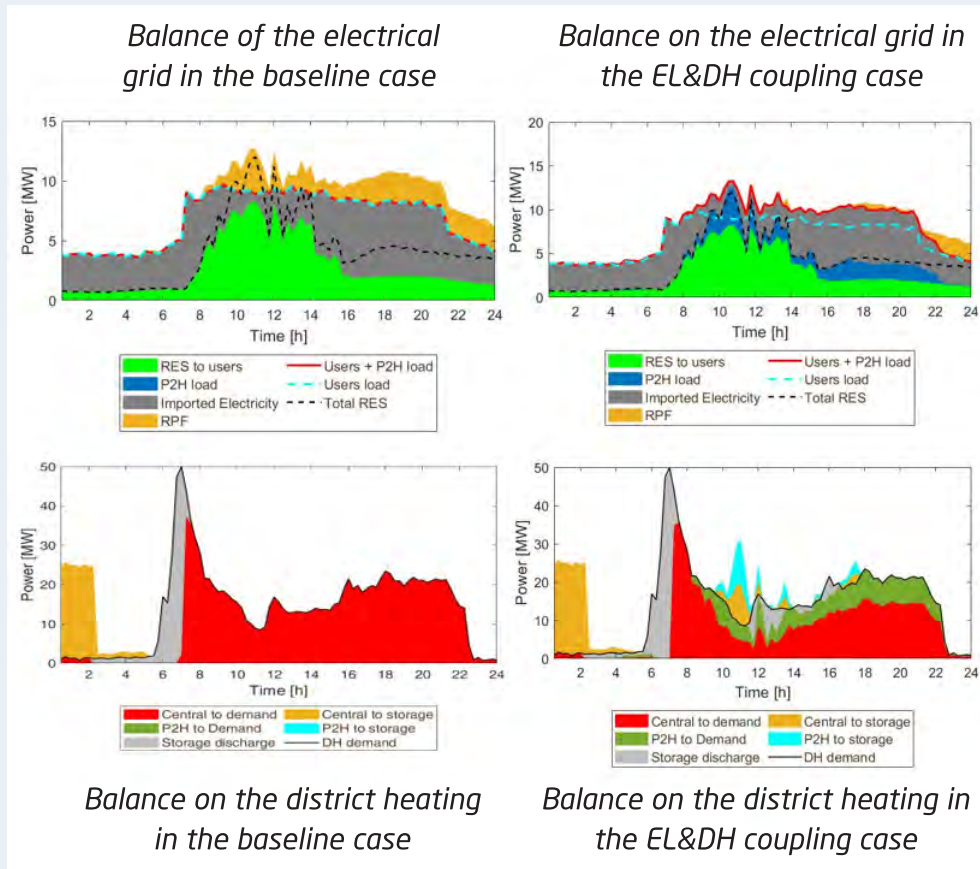

Figure 17: Synergies between energy networks: electrical grid and district heating (winter day)

Figure 17 focuses on the results of a typical winter day while Figure 18 of a typical summer day. In the second case, the RPF cannot be reduced, as expected, and the impact of the P2H is negligible for optimising the distribution system operation.

The PLANET Project: A Tool for Flexibility in the Energy Transition

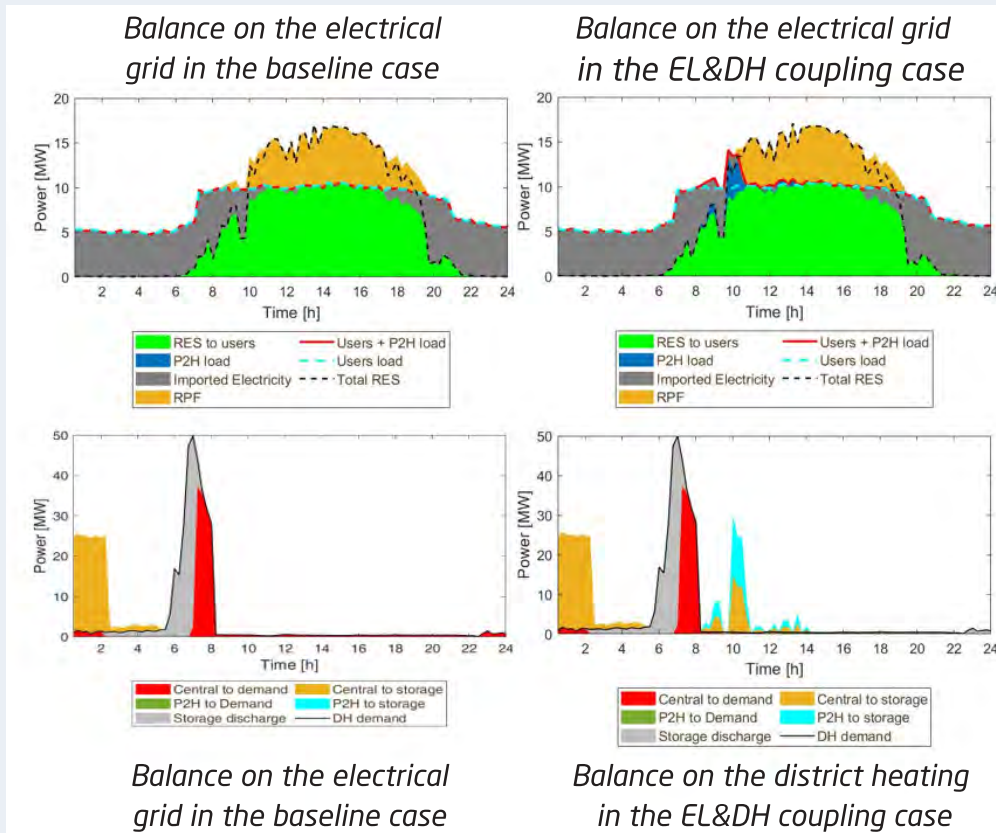

Figure 18: Synergies between energy networks: whole electrical grid and whole district heating (summer day)

Similar results are found in the case of yearly simulations, which are presented in Table 2. Namely, the RPF is not reduced during the summer but it shows significant drop during the winter. The reduction of the heat import is much higher in winter than in summer (about 2 GWh in winter and less than 1 GWh in summer).

Technical KPI	Winter			Summer		
	Without P2H	With P2H	Improvement (%)	Without P2H	With P2H	Improvement (%)
RPF [MWh]	199.0	45.6	77	964.5	881.7	8.5
RES utilisation [GWh]	2.16	2.31	6.9	3.58	3.66	2.2
Grid Losses [MWh]	10.13	9.59	5.3	10.06	9.85	2.1
Heat import [GWh]	11.1	9.3	16	2.93	1.94	33
Electricity Consumption [MWh]	0.0	490.3	-	0.0	178.1	-
Heat Production [GWh _{th}]	0.0	1.82	-	0.0	0.65	-

Table 2: Technical KPIs for different seasons

The PLANET Project: A Tool for Flexibility in the Energy Transition

Finally, the value of the grid losses, thanks to the presence of the asset, improves more in winter than in summer (both in percentage and as final value).

3.2 Exploitation of P2G and NG network potential

Figure 19 presents the coupling topology of the Electrical grid (EL) and Natural Gas network (NG) linked through centralized P2G facilities. The NG network is represented with a radial structure and is composed of two equivalent nodes. The information about the allocation of the P2G systems is shown in Table 3.

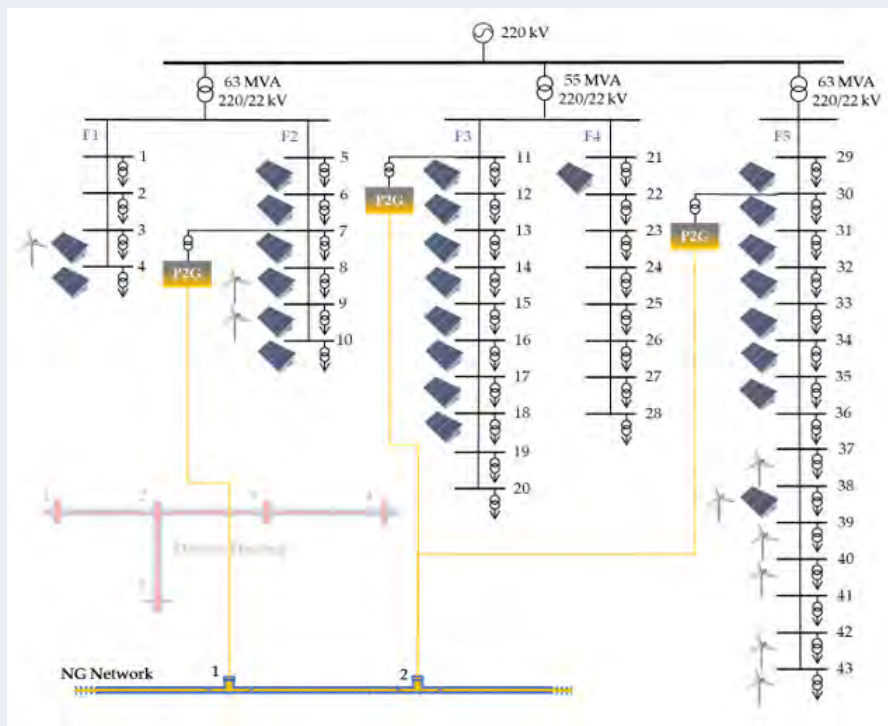

Figure 19: Case study topology: P2G

<i>Asset</i>	<i>EL Network Node</i>	<i>NG network Node</i>	<i>Nominal power</i>
<i>P2G1</i>	7 (Feeder 2)	1	2.5 MWeI
<i>P2G2</i>	11 (Feeder 3)	2	2.5 MWeI
<i>P2G3</i>	30 (Feeder 5)	2	2.5 MWeI

Table 3: Allocation and nominal power of P2H systems

The PLANET Project: A Tool for Flexibility in the Energy Transition

Figure 20 shows that the RPF of the baseline scenario is alleviated thanks to the P2G flexibility utilization. The injection of Synthetic Natural Gas (SNG) in the gas network does not affect significantly its operation, because the amount of injected SNG is negligible with respect to the total amount of gas served by the GN.

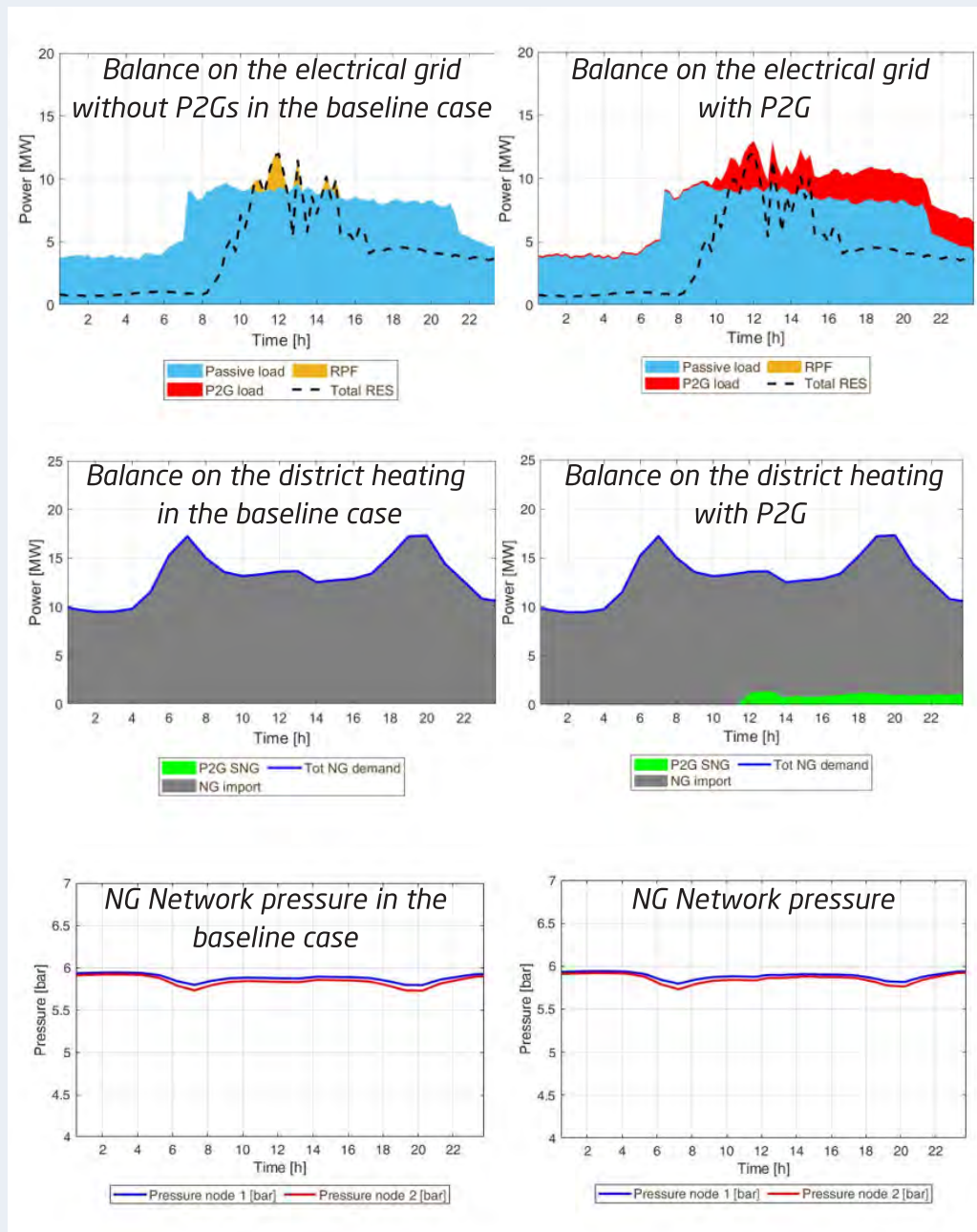

Figure 20: Synergies between energy networks: whole electrical grid and GN (winter day)

The PLANET Project: A Tool for Flexibility in the Energy Transition

When examining a typical summer day, as shown in Figure 21, the RPF is higher and therefore strongly reduced. Due to the amount of gas required by the gas loads, the GN works already close to the pressure limits. As a result, this poses a constraint in the power flow optimisation of the electrical grid. To this end, there is some residual RPF in the P2G flexibility scenario.

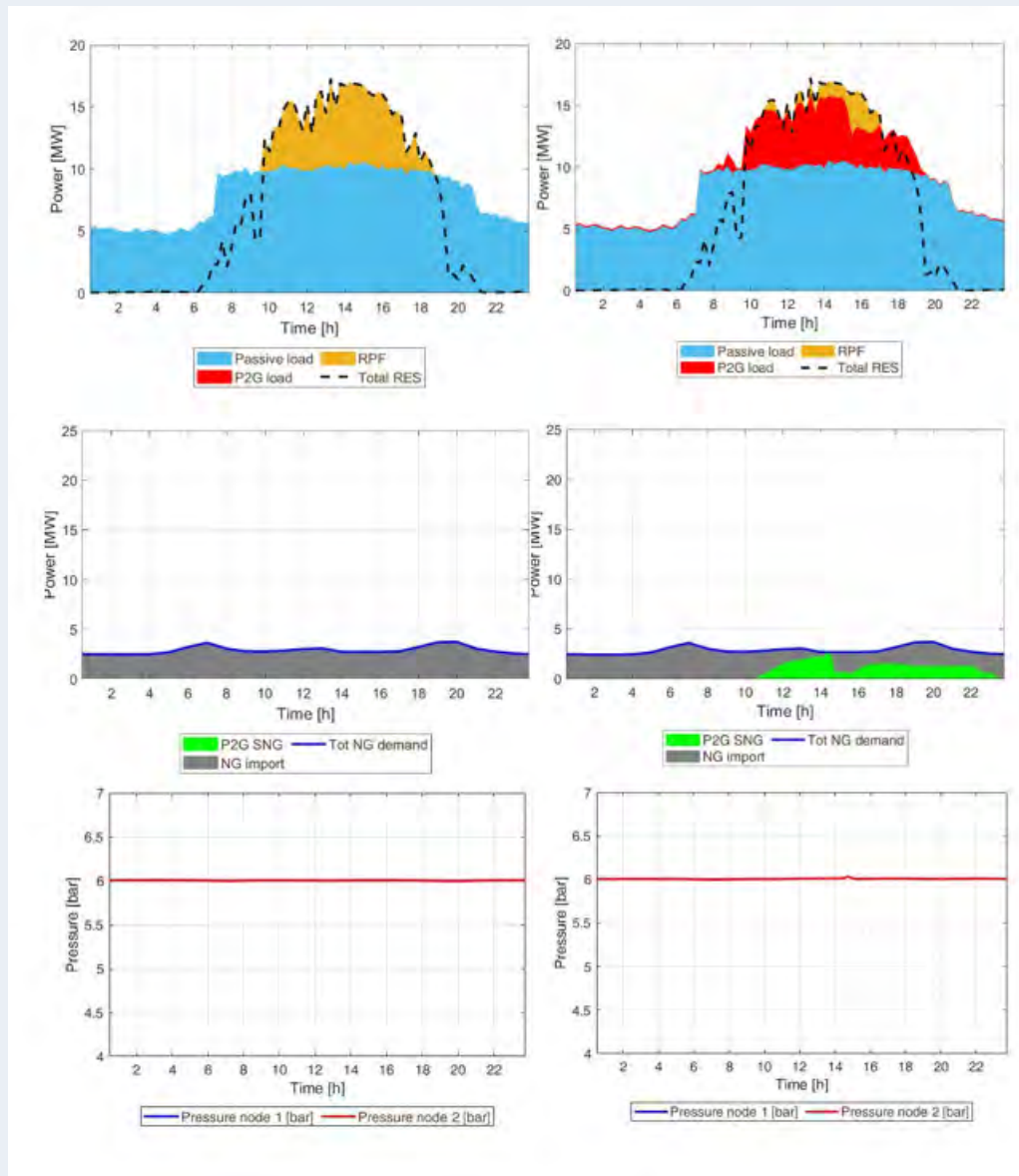

Figure 21: Synergies between energy networks:
whole electrical grid and NG network (summer day)

The PLANET Project: A Tool for Flexibility in the Energy Transition

Similar conclusions emerge in the case of yearly simulations which are presented in Table 4. The RPF is reduced in all the seasons at different but equally high rates, namely 95% in winter, 78.2% during the midseason and 85.8% in summer. The reduction of the gas import is higher in summer than in winter and the grid losses improve in all the cases at rates ranging from 7.6% to 28.5%.

Technical KPI	Winter			Midseason			Summer		
	w/o P2G	With P2G	Improv. (%)	w/o P2G	With P2G	Improv. (%)	w/o P2G	With P2G	Improv. (%)
RPF [MWh]	202.8	10.2	95.0	1377.3	301.3	78.1	959.8	136.3	85.8
RES utilisation [GWh]	2.08	2.23	7.2	2.84	3.92	38	3.45	4.27	23.8
Grid Losses [MWh]	9.92	9.17	7.6	9.83	7.02	28.6	9.82	7.91	19.5
NG import [GWh]	5.57	5.41	2.9	2.48	2.17	12.5	1.04	0.79	24.0
Electricity Consumption [MWh]	0.0	380.0	100	0.0	679.5	100	0.0	570.5	100
SNG Production [MWh]	0.0	162.6	100	0.0	311.8	100	0.0	256.1	100

Table 4: Technical KPIs for different seasons in P2G case

3.3 Exploitation of VES and buildings potential

The Virtual Energy Storage (VES) simulation utilizes a customised topology that is based on the pilot site of SOREA in St. Julien Montdenis. Namely, the grid uses only one feeder of the basic template topology and implements the network parameters extracted by the electrical grid of SOREA.

As shown in Figure 22, the interactions within the range of electrical distribution grid are examined involving the thermal end-use sector. The existing buildings are considered to be equipped with electric heating/ cooling units whose operation is examined in combination with the thermal inertia of the building spaces. Two parallel optimisations on building and on district level take place in order to convene to a global optimum that allows maximum utilization of the renewable generation through pre-heating/cooling techniques without hampering user comfort or leading to uncontrolled consumption increase.

The PLANET Project: A Tool for Flexibility in the Energy Transition

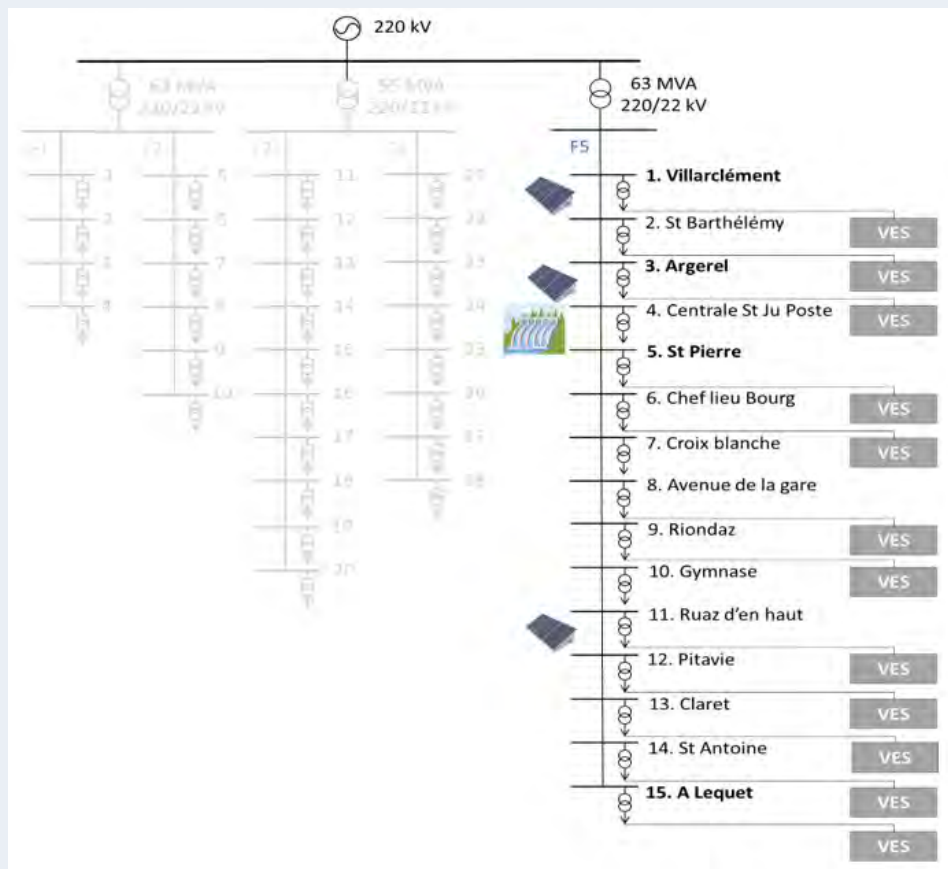

Figure 22: Case study topology, SOREA grid

The total passive load power is 9.43 MW divided among different types of users (residential, office, commercial). The grid includes both hydro and PV plants, with a total RES installed power equal to 3.95 MW. The total simulated renewable penetration is ca. 10% higher than today as it refers to future energy scenarios with more reliance on distributed variable generation for the load coverage.



SOREA Local Electrical Distribution Network

- Eight (8) towns in the local region
- 305 MV/LV substations in total
- Total clientele of 14,000 with 12,700 energy meters
- Simulation involved the town of St. Julien Montdenis with 1,110 end-users connected to 31 MV/LV nodes.
- Today, the sum local renewable energy production is 30% of total annual energy consumption

The PLANET Project: A Tool for Flexibility in the Energy Transition

The information regarding the distribution of the electrical loads and the buildings are shown in Figure 23.

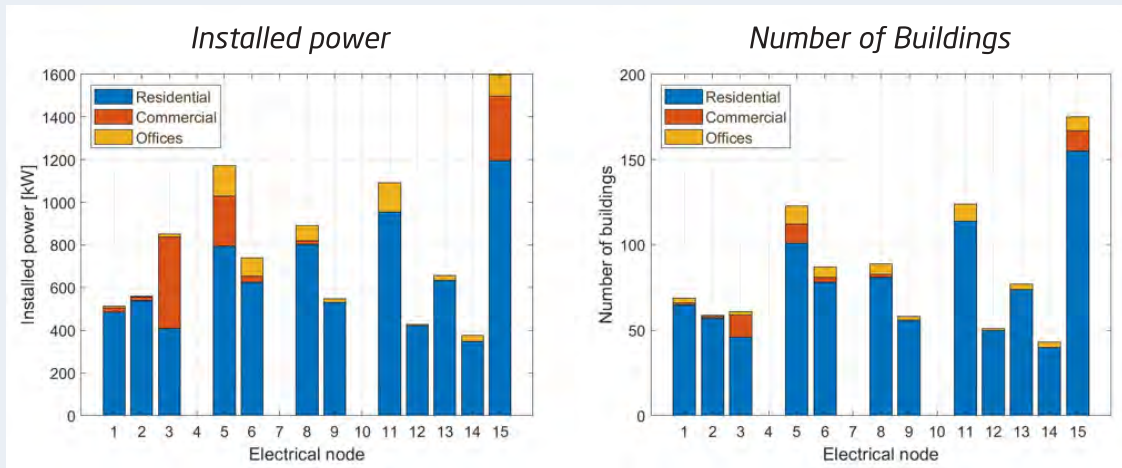

Figure 23: Nodal distribution for the VES case study

The VES has significant operational impact between October and March, when the end users' heating needs are high. As it is based on electric heating, the operation during summer is negligible. Regarding the winter day (in Figure 24 the buildings and external temperatures are depicted), it has been concluded that the RPF is alleviated due to the flexibility exploitation and demand modulation (Figure 25).

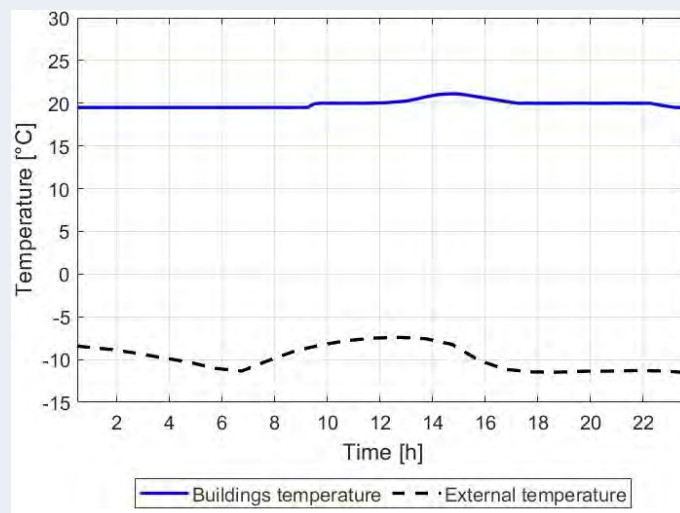

Figure 24: Temperature profile in winter

The PLANET Project: A Tool for Flexibility in the Energy Transition

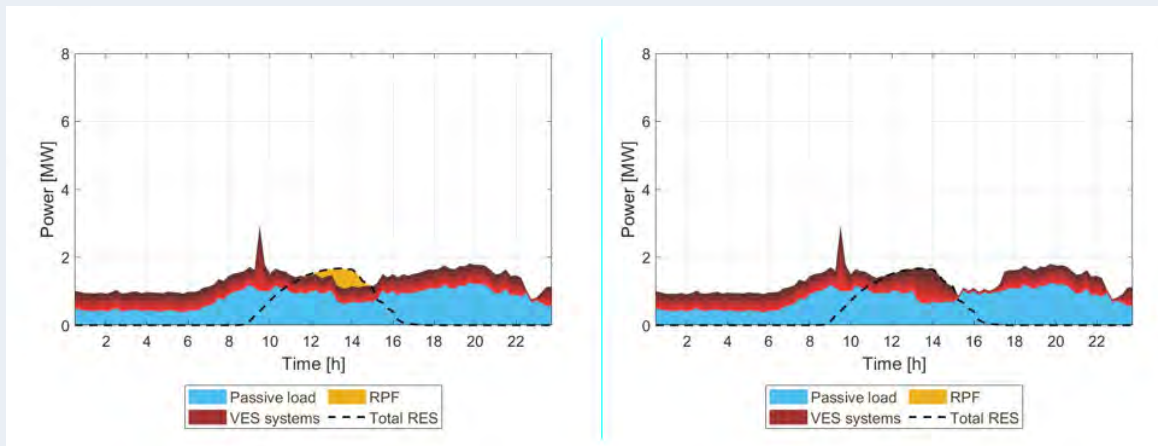

Figure 25: Balance on electric grid (winter day)

In midseason, the VES is highly utilized in order to extract flexibility and modulate demand for providing energy services. In Figure 26 the building's temperature is presented considering the comfort boundaries defined by the users. As shown in Figure 27, in periods following the flexibility provision, the total thermal demand is reduced.

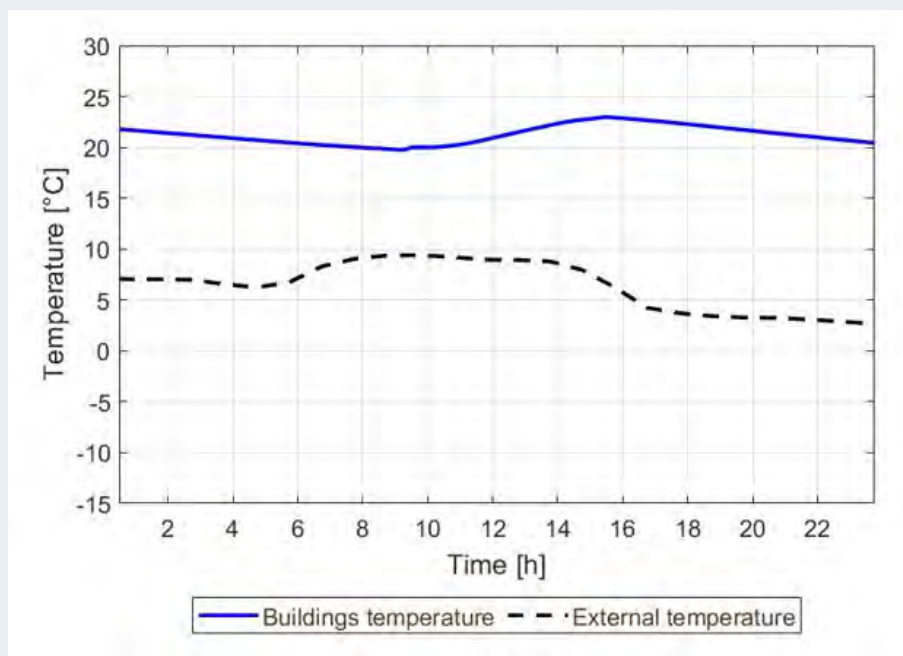

Figure 26: Temperature in midseason

The PLANET Project: A Tool for Flexibility in the Energy Transition

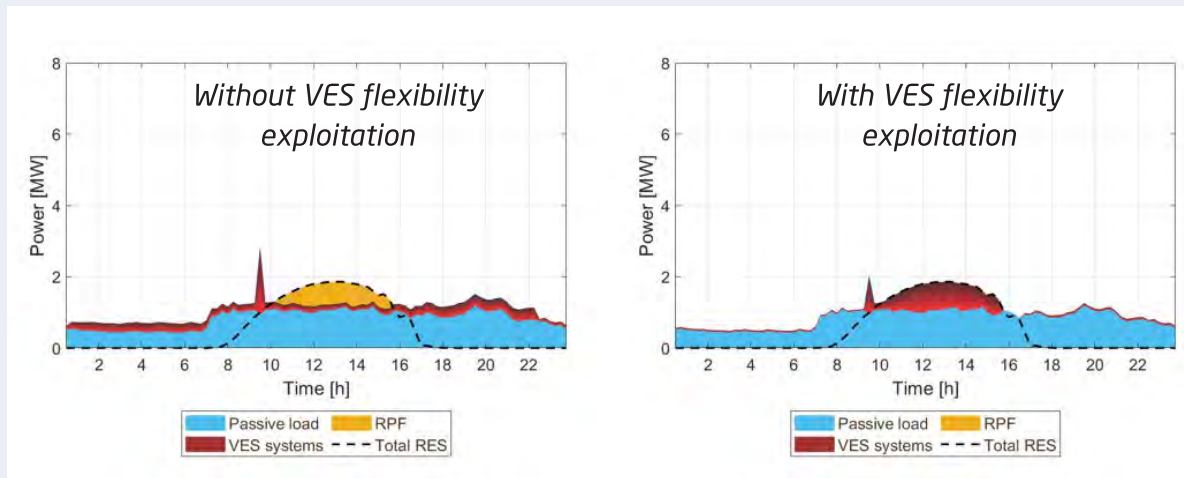

Figure 27: Balance on electric grid (winter day)

Table 5 summarizes the results from simulations on seasonal basis with time horizon from October to March. The overall conclusion is that the reverse power flow is highly improved, the grid losses are reduced as expected and the self-consumption increased without the total increase of the overall electricity consumption. Therefore, collective self-consumption based on vRES was validated based on VES-enabled demand modulation without hampering end-user comfort or electricity bills.

Technical KPI	October-March		
	Without VES flexibility	With VES flexibility	Improvement (%)
<i>RPF [MWh]</i>	0.41	0.21	48.8
<i>RES utilisation [MWh]</i>	1.87	2.08	27.4
<i>Grid Losses [MWh]</i>	14.69	14.23	11.2
<i>Electricity Consumption [MWh]</i>	1.70	1.70	0%

Table 5: Technical KPIs for different seasons (VES case)

The PLANET Project: A Tool for Flexibility in the Energy Transition

4. STANDARDIZATION PROPOSALS

One of PLANET project's most important activity lines focused on the construction of a standardization punch list and its consequent promotion within standardization organizations, committees and working groups. The Planet Information Model (PIM) and system architecture were created based on interoperability standards and reference models. Additionally, from the beginning of the project, the interaction with IEC standardisation body TC 57 WG 17 was established through a consortium partner. This contact was utilised to bring forth the Preliminary Work Item (PWI) on Thermal Energy Systems (TES) and the proposal for gas-based DER (Distributed Energy Resource) documented in the PLANET standardisation achievements [19] [20].

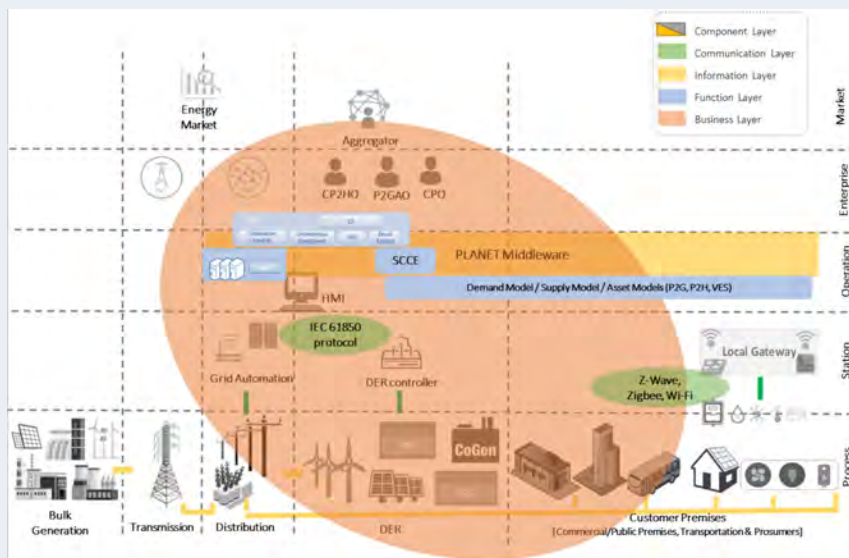

Figure 28: Mapping of PLANET System Architecture upon SGAM plane

In the task force TF 90-27 elaborations, the 3 major PLANET use cases on TES have been promoted and finally included in the IEC 61850 Technical Report on Thermal Energy Systems (TR 90-27) [21]. The modelling principles for non-electric DER developed within PLANET project have been included in the IEC 61850-7-420 Edition 2 (CDV) [22].

The PLANET Project: A Tool for Flexibility in the Energy Transition

Finally, the modelling principles for concrete P2H units and CHP, for modelling connections to heat and gas grids and for modelling energy services to the electric grid are incorporated in the IEC 61850 Technical Report on Thermal Energy Systems (TR 90-27). In a nutshell:

1

The PLANET standardization achievements pave the way for enhancing the information models of the current IEC 61850-7-420 standard with information models for thermal energy systems and gas systems and hence widen the scope of IEC 61850-7-420 considerably. Information modelling conducted in PLANET provides a good basis for modelling sector coupling in IEC 61850. Future standardization activities will build on this basis to ensure that future developments in this area are reflected in IEC 61850 data modelling.

2

The modelling principles for concrete P2H units and CHP, for modelling connections to heat and gas grids and for modelling energy services to the electric grid are incorporated in the IEC 61850 Technical Report on Thermal Energy Systems (TR 90-27).

3

TC 57 WG 17 considers the PLANET Information model as an important and relevant contribution for the running work on Thermal Energy Systems and recommends using the PIM for deducing Logical Node Classes and their IEC 61850 data objects for the Technical Report 90-27.

4

The data attribute semantics for the PLANET Information Model are enhanced in close cooperation with the TF 90-27 leader. These enhanced semantics along with the corresponding resource models for P2H, VES and CHP are incorporated in the IEC 61850 Technical Report TR 90-27. The mapping to IEC 61850 Logical Nodes and data objects will be based on them.

5. POLICY AND MARKET REFORM PROPOSALS

The decarbonisation of energy systems goes along with a steadily increasing importance of P2X technologies. At this point in time, several solutions that are considered essential flexibility options for future vRES-based energy systems only play minor roles in many European energy markets. This applies to P2G installations across Europe, and in some Member States also to P2H systems. Along with increasing the capacities, it seems necessary to improve the exploitation of the flexibility potential of the installed systems. The existing issues can be partially attributed to the fact that the needs for certain services offered by P2X systems have not emerged yet but also due to inadequate market rules and policies [23]. Given the necessity of large-scale investments, establishing adequate institutional frameworks across the Member States is indispensable for the cost-efficient achievement of a reliable and sustainable European energy supply system [24].

Within PLANET, the research activities [25][26][27] have considered actual and possible problems regarding the compatibility of the current institutional frameworks, the incentives for all actors, and the environment for investments to foster energy system integration (ESI) [28]. With reference to the results listed in Table 6, barriers are classified in two typologies: general-economic-institutional barriers (e.g., costs, consumer acceptance, legal or regulatory constraints) and barriers due to specific features of case studies (e.g., absence of specific incentives or feed-in tariffs, complex technology requirements).

The PLANET Project: A Tool for Flexibility in the Energy Transition

General economic and institutional barriers	Specific barriers derived from the analysis of PLANET case studies
<ul style="list-style-type: none"> • Cost of technologies • Intrinsic risk of innovation • Coordination between grid users • Access to data • Consumer acceptance • Role of the regulator • Behind the meter behaviour • Current organisational constraints of NRAs 	<ul style="list-style-type: none"> • The P2X concept is not mature yet • The system need is not yet high enough • Essential technical infrastructure is not in place • The market prices are too low / the input prices are too high • High investment uncertainty • The demand is not adequately articulated • (Techno-) Institutional barriers • Problematic taxes, levies etc.

Table 6: Compilation of barriers for P2X investments

General consideration regarding the choice of instruments

Regarding the evaluation of concrete regulatory provisions and policy measures, it is important to recognize that comprehensive 'one-size-fits-all' solutions do not exist. Different technologies can require completely different policies. Moreover, focusing on a single technology, the requirements significantly vary according to the context, namely the social and market conditions. The suitability of measures depends, for instance, on the technical supply system, the relevant market constellations, existing regulations, etc. In this context, it is also necessary to consider factors that matter for the functioning of market-based or other institutional mechanisms. Furthermore, it should be recognized which roles European countries plan for certain P2X concepts in their future energy supply systems. Table 7 presents an overview of evaluated policy tools per stakeholder.

The PLANET Project: A Tool for Flexibility in the Energy Transition

Stakeholder	Policy	Effect
Generator/aggregator	R&D grants	Enable the realisation of projects in areas where they are not yet commercially feasible
End-user and generator	Investment grants	Lower investment cost
End-user and generator/ aggregator	Modification of taxes and levies	Make cleaner energies and technologies more competitive
Various	Greenhouse Gas (GHG) emission charges on the use of fossil substitute energy sources	Make cleaner energies and technologies more competitive
End-user	Reduction of existing taxes and levies on electricity, including self-consumption	Make cleaner energies and technologies more competitive
End-user and generator	Production premiums and feed-in tariffs	Make investment more attractive through financial support for energy produced

The PLANET Project: A Tool for Flexibility in the Energy Transition

Stakeholder	Policy	Effect
Generator	Increase of allowed hydrogen infeed to NG grids	Extend the opportunities for P2G (P2H2) investments
End-user and aggregator	Opening of ancillary markets	Increase revenue sources for flexible technologies
Various	Further target measures that might indirectly support P2X	Overcome barriers that limit P2X large-scale adoption
DSO	Modifications to the DSO regulation	Align incentives across the grid and foster adoption
Generator/aggregator and regulator	Comprehensive long-term strategies	Lower investment cost and enhanced knowledge sharing

Table 7: Overview of some selected policy measures

The analysis did not find any specific measure that could be regarded as a 'silver bullet', making any further action superfluous.

The PLANET Project: A Tool for Flexibility in the Energy Transition

By contrast, in all cases a mix of policies seems to be necessary for overcoming the barriers that inhibit an efficient large-scale application of the P2X solutions.

DSO regulation as a key tool for integrating relevant local knowledge

The DSOs, both electric and gas, cover a pivotal role in P2X concepts. They possess high-value information for the creation of an efficient investment and operating decisions because they constitute the main stakeholders targeted in the P2X service offerings. While user adoption can allow for system integration at the small scale, large adoption may require that DSOs play a more active role in the investment and operation process. This possibility, under the current regulatory framework, cannot be achieved due to unbundling constraints. When designing the institutional environment for DSO decisions, the following aspects should be taken into consideration:

1 'Regulatory sandboxes', i.e. temporary exemptions of innovative solutions from unbundling requirements, facilitates the active involvement of DSOs and thus the adoption of novel concepts.

2 In such exemptions, a market test analysis should be performed in order to avoid market distortions. Proper regulations should contain clear sets of rules that allow DSOs to identify such situations and establish the scope of allowed investments and operations.

3 Requiring DSOs to present cross-sector development plans could efficiently increase their incentives to consider and engage in energy system integration solutions.

The PLANET Project: A Tool for Flexibility in the Energy Transition

The abovementioned regulatory sandboxes approach represents one particular way of promoting the implementation of innovative concepts.

The vital importance of consumer electricity prices

Our analysis has demonstrated that high consumer prices for electricity in comparison to the prices for fossil substitutes (such as natural gas and petroleum products) often constitute the main problem for the economic feasibility of P2X concepts. In many cases such price constellations might misrepresent the aggregate costs and benefits from a social perspective. The large range of measures that could help achieve more adequate price ratios include the following options:

1

Establishing a significant CO₂ price on fossil fuels used in heating and road transportation. Fixing prices in advance tends to increase the steering effect such measures have on investors.

2

Removing or reducing taxes or levies imposed on electricity used for P2X applications is an alternative policy.

3

In the exceptional case that a certain P2X system contributes to overall efficiency but a market-based solution may not emerge, exemptions from unbundling rules might be allowed for the provision of the P2X services by the DSO.

4

The regulatory framework must not unjustifiably favour grid investments over P2X solutions.

The PLANET Project: A Tool for Flexibility in the Energy Transition

When considering any of the measures, the potential impact on energy poverty should also be considered. Negative implications for low-income households should be avoided when disincentivizing certain technologies.

The cost of electricity production depends on the sector design. Hence, the long-term competitiveness of P2X solutions relies on a holistic sector design optimisation and not solely on targeted measures.

Reducing investment costs and uncertainty

Tackling barriers related to high investment costs and uncertain payback can especially be reasonable, if extending the capacity of certain P2X technologies is generally considered conducive to long-term cost-efficiency. This can be done by introducing investment-related measures, such as investment grants or similar ways of funding parts of the investment costs (e.g., periodic capacity payments). EU Taxonomy, the upcoming classification system of sustainable economic activities complementing the EU Green Deal objective, could be seen as an added-value driver to target investments in sustainable projects and technologies, such as P2X. Alternatively, operation-related measures can be used, such as production premiums or feed-in premiums/ tariffs in case the output is fed into the grid. While investment-related payments can be particularly effective in terms of risk mitigation, production-related payments also incentivize higher usage rates of P2X systems.

The importance of the uncertainty aspect can vary a lot between different cases. As far as investments by consumers, landlords etc., or R&D activities are concerned, uncertainty regarding a successful payback might often not be the most crucial factor for the evaluation of projects. In contrast to consumer, landlord or R&D pilot investments, for the commercial investors whose business models are based on profit generation, the degree of investment risk can be decisive for a P2X installation.

The PLANET Project: A Tool for Flexibility in the Energy Transition

Special considerations regarding Power-to-Hydrogen concepts

Green hydrogen plays a key role in many scenarios for the future energy supply systems, but is currently at a less mature state of development. Significant efficiency gains are still possible. The development of comprehensive European and national hydrogen strategies is essential for meeting the great challenges of a sustainable and reliable hydrogen supply system. Regarding the existing gas transportation and storage infrastructure, one important part of long-term strategies regards the role of existing natural gas grids in future hydrogen supply systems. In the meantime, it seems advisable to already exploit the possibilities of injecting certain percentages of hydrogen into natural gas pipelines to promote the development of P2H₂. Significant increases of the allowed injections volumes appear to be possible in many cases without entailing disproportionate costs for the necessary technical and institutional adaptations.

An outlook for further measures

In many cases the following measures can represent suitable additional components of the institutional frameworks:

1

While the significance of revenues from ancillary services markets for investment decisions is debatable, granting small-scale P2X systems access to these markets can be regarded as a no-regret measure. This holds true, as long as the achievable efficiency gains are not offset by transaction costs (on the sides of the network operators, the market participants, and the regulator) connected to the reform and the inclusion of the small-scale offers.

2

The presence of smart grids is a precondition for some P2X concepts. Fostering the smart grids development and the development of connected ICT infrastructure can therefore be of great help regarding the implementation of such solutions. In this context it is important to foster standardisation requirements.

The PLANET Project: A Tool for Flexibility in the Energy Transition

3

In cases with a lack of effective data transparency rules and clear third-party access policies, these problems should be tackled to improve the coordination among grid users and thus the possibilities to develop P2X concepts.

4

Additional incentives could also be provided to off-grid system that help with decarbonisation (e.g., H2 for trains where investments in a new catenary were to be too costly).

In general, it is important to continue and enhance the support of the development of innovative P2X concepts. In view of the high complexity of ESI and its great importance, it seems imperative to devise comprehensive and coherent long-term strategies for the development of the connected European energy supply systems and evolution of the involved industries. Close cooperation on these issues between the Member States is crucial for achieving efficient and sustainable results.



St. Julien Montdenis: a cost-benefit analysis

The integration of intermittent renewable electricity sources will raise new constraints on the distribution grid in case of future penetration increase. Against the traditional solutions of grid expansion in order to confront congestion management, PLANET platform can contribute in optimal planning of demand modulation on district-level based on context-aware VES-enabled demand flexibility forecasts from local prosumers.

A yearly simulation from the French pilot site has displayed very optimistic results.

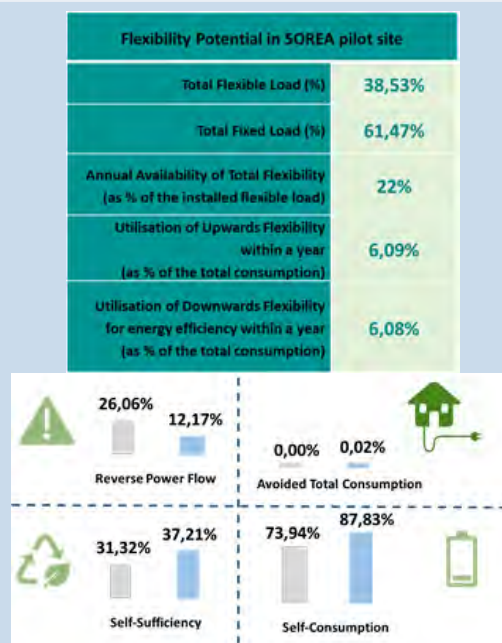

The PLANET Project: A Tool for Flexibility in the Energy Transition

Cost-benefit analysis of the IREN Pilot site

The IREN pilot plant (Turin, Italy) was installed to study how heat pump systems can be leveraged to offer services to the electricity grid. The summer and winter experimental data were used to validate a more general model. In the simulation, the plant was controlled to improve the match between renewable production and electricity demand. The results confirm that an aggregation of small-scale heat pump plants can provide useful services to the electrical network. Moreover, the participation in flexibility services represents a possible source of income for plant owners. This additional income could facilitate the diffusion of these 100% electricity-based heating cooling technology.

Flexibility Potential in IREN pilot site	
Number of aggregated plants	50
Total aggregated capacity	3700 kW
Utilisation of Upward Flexibility (as % of the total consumption)	19,54 %
Utilisation of Downward Flexibility (as % of the total consumption)	63,27 %

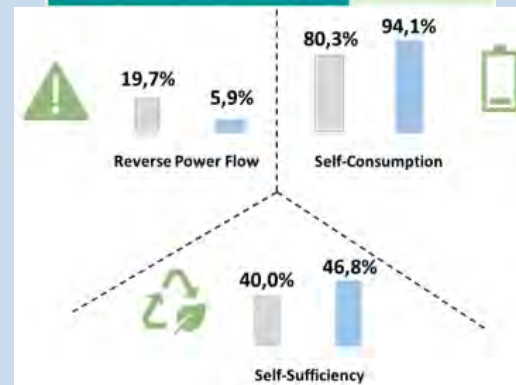

REFERENCES

- [1] IEC: IEC 61850-7-420 Ed.2.0 (CDV) - Communication networks and systems for power utility automation - Part 7-420: Basic communication structure - Distributed energy resources and distribution automation logical nodes.
- [2] IEC: TR 90-27 (DTR) - Communication networks and systems for power utility automation - Part 90-x: Use of IEC 61850 for thermal energy system connected to power grid.
- [3] A. Schröder, C. Kahlen, M. Martino et A. Papanikolaou, «The EU Research Project PLANET,» InTechOpen, 2018.
- [4] Bacher, R., «ETIP SNET Vision 2050,,» Horizon 2020, EU , 2019.
- [5] D. Papadaskalopoulos, G. Strbac, P. Mancarella, M. Aunedi and V. Stanojevic, «“Decentralized Participation of Flexible Demand in Electricity Markets - Part II: Application with Electric Vehicles and Heat Pump Systems”,» IEEE Transactions on Power Systems, vol. 28, n° %14, pp. 3667-3674, 2013.
- [6] Hossein Ameli et al, «Value of gas network infrastructure flexibility in supporting cost-effective operation of power systems,» Applied Energy, vol. 202, pp. 571-580, 2017.
- [7] DNV GL, Imperial College London, NERA Economic Consulting, «Integration of renewable energy in Europe,» DNV GL , UK, 2012.
- [8] Kavvadias, K.; Jiménez-Navarro, J.P.; Thomassen, G., «Decarbonising the EU heating sector: integration of the power and heating sector,» Publications Office of the European Union: Luxembourg , vol. JRC114758, n° %1ISBN 978-92-76-08386-3, EUR 29772 EN , 2019.
- [9] Hypertech, «PLANET system architecture,» H2020 project, EU, 2019.
- [10] C. Cambini, R. Congiu, T. Jamasb, M. Llorca et G. Soroush, «Energy Systems Integration: Implications for public policy,» Energy Policy, vol. 143, 2020.
- [11] E. Guelpa, V. Verda (2019). Compact physical model for simulation of thermal networks. Energy 175: 998-1008
- [12] E. Guelpa (2020). Impact of network modelling in the analysis of district heating systems. Energy, 213: 118393
- [13] R. Weiss, J. Savolainen, P. Peltoniemi, and E. Inkeri, "Optimal scheduling of a P2G plant in dynamic Power Heat and Gas markets," im 10th International Renewable Energy Storage (IRES), 2016.

- [14] T. Sihvonen, J. Savolainen and M. Tähtinen, "Modelling and Simulation of PtG Plant Start-Ups and Shutdowns," in Proceedings of The 9th EUROSIM Congress on Modelling and Simulation, EUROSIM 2016, Oulu, Finland, 2016.
- [15] PLANET consortium, D2.7: Final PLANET P2H process/system model
- [16] PLANET consortium, D4.3: PLANET Integrated DSS and Monitoring / Orchestration Cockpit
- [17] PLANET consortium, D1.1: End user requirements and specifications for the PLANET system
- [18] PLANET consortium, D4.1: Preliminary interfaces between electricity, gas, transportation and heating/cooling networks
- [19] PLANET consortium, D4.5: Standardisation punch list, 2020
- [20] PLANET consortium, D7.10: Report on activities for the promotion of PLANET standardization punch-list, 2020
- [21] IEC: TR 90-27 (DTR) - Communication networks and systems for power utility automation - Part 90-x: Use of IEC 61850 for thermal energy system connected to power grid
- [22] IEC: IEC 61850-7-420 Ed.2.0 (CDV) - Communication networks and systems for power utility automation - Part 7-420: Basic communication structure - Distributed energy resources and distribution automation logical nodes
- [23] PLANET consortium: D6.3: Interaction between market functioning and regulation
- [24] Cambini, C., Congiu, R., Jamasb, T., Llorca, M., Soroush, G., 2020. Energy Systems Integration: Implications for public policy. Energy Policy 143, 111609. <https://doi.org/10.1016/j.enpol.2020.111609>
- [25] PLANET consortium, D3.4: PLANET Common Information Model
- [26] PLANET consortium, D4.5: Standardization punchlist
- [27] PLANET consortium, D7.10: Report on activities for the promotion of PLANET standardization punchlist
- [28] PLANET consortium, D7.9: Policy/Market reform recommendations report

All PLANET public deliverables are available on the project [website](#).

CONTACTS

POLITO

Marco Badami
Mariapia Martino
Andrea Mazza
Gabriele Fambri
Cesar Diaz Londono
Vittorio Verda
Elisa Guelpa
Carlo Cambini
Raffaele Congiu

VTT

Robert Weiss

HYPERTECH

Vasiliki Katsiki
Antonis Papanikolaou
Stefanos Makris
Francesca Chazapi

CERTH

Angelina Bintoudi

VAASAETT

Albert Hoffrichter
Konstantinos Kanellos (design)
Thanh Nguyen (design)

FGH

Christoph Kahlen

MERIT

Theodoros Kakardakos

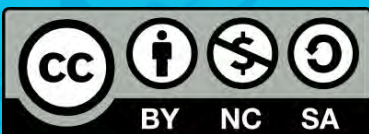

This project has received funding from the European Union's Horizon 2020 research and innovation programme under grant agreement No 773839

This publication reflects only the PLANET consortium views and the European Commission is not responsible for any use that may be made of the information it contains