

Optimization for wideband linear array antenna through bottom-up method

Original

Optimization for wideband linear array antenna through bottom-up method / Mir, F.; Matekovits, L.; Kouhalvandi, L.; Gunes, E. O.. - ELETTRONICO. - (2020), pp. 51-54. (2020 IEEE International Conference on Electrical Engineering and Photonics, EExPolytech 2020 Peter the Great St. Petersburg Polytechnic University (SPbPU), rus 15-16 Oct. 2020) [10.1109/EExPolytech50912.2020.9243969].

Availability:

This version is available at: 11583/2862174 since: 2021-01-19T09:51:15Z

Publisher:

Institute of Electrical and Electronics Engineers Inc.

Published

DOI:10.1109/EExPolytech50912.2020.9243969

Terms of use:

This article is made available under terms and conditions as specified in the corresponding bibliographic description in the repository

Publisher copyright

IEEE postprint/Author's Accepted Manuscript

©2020 IEEE. Personal use of this material is permitted. Permission from IEEE must be obtained for all other uses, in any current or future media, including reprinting/republishing this material for advertising or promotional purposes, creating new collecting works, for resale or lists, or reuse of any copyrighted component of this work in other works.

(Article begins on next page)

Optimization for Wideband Linear Array Antenna through Bottom-Up Method

1st Farzad Mir

*Department of Electronics and Telecommunications
Politecnico di Torino
Turin, Italy
farzad.mir@studenti.polito.it*

2nd Lida Kouhalvandi

*Department of Electronics and Communication Engineering
Istanbul Technical University
Istanbul, Turkey
kouhalvandi@itu.edu.tr*

3rd Ladislau Matekovits

*Department of Electronics and Telecommunications
Politecnico di Torino
Turin, Italy
ladislau.matekovits@polito.it*

4th Ece Olcay Gunes

*Department of Electronics and Communication Engineering
Istanbul Technical University
Istanbul, Turkey
gunesec@itu.edu.tr*

Abstract—This paper presents an automated design methodology for electromagnetic-based (EM-based) optimization of an array antenna by applying bottom-up approach. Firstly, one single antenna is optimized then *bottom-up optimization (BUO)* method has been implemented by increasing the number of single antennas, sequentially. The proposed method leads to automatically find an optimal array by setting the distance between single antennas. The optimization method is performed in an automated environment with the help of an electronic design automation (EDA) tool and a numerical analyzer. The results of the final design have been compared by means of two EDA tools such as ADS and HFSS. The optimized array antenna works in the frequency band from 12.9 GHz to 14.3 GHz. It offers a linear gain performance higher than 7.5 dB. The simulations in both ADS and HFSS tools illustrate a good match in S-parameter and gain simulation output results.

Index Terms—array antenna, automated design, bottom-up optimization (BUO), electromagnetic.

I. INTRODUCTION

Recently, wireless and communication systems have played significant roles in humans' life which have led to a growth in the demand for using antennas [1], [2]. Thus, a need for designing antennas in efficient and effective ways can be felt [3]. In modern communication system antennas, high gain and acceptable impedance bandwidth (IBW) are required since antennas with such characteristics are known to be key components in these electronic systems. Usually, the employed antennas rely on microstrip technology due to their advantages such as low weight, reduced space, and easy fabrication [4].

Array antennas are important systems in telecommunication applications due to the high-gain performance and well-matched capability for long distance communications [5]. Designing an array antenna with the use of traditional methods is not straightforward and needs additional efforts due to the complexity of the structures. Recently, to tackle these problems, some optimizations for solving the high-dimensional issues have been studied and some effective

methods to design more practical antennas by the means of optimization ways have been reported in [3], [6]-[8]. Some of the successfully applied nonlinear optimization methods [9] for designing antennas include: fruit-fly method [5], particle swarm optimization [10], and functional surrogate-based method [11].

In this study, we focus on optimizing an array antenna automatically by applying bottom-up optimization (BUO) method. The optimization process is performed in an automated environment with the combination of an Electronic Design automation (EDA) tool and a numerical analyzer to be independent from the designer's experience [12]. Also, BUO method is applied in this design as it is a hierarchical multilevel approach leading to enhanced accuracy [13], [14]. The proposed optimization method provides the automated platform by the co-operation between ADS and MATLAB [15] and BUO is applied to determine the: i) number of single antennas in the array shape, and ii) optimal distance between single antennas. The proposed automated BUO method is electromagnetic-based (EM-based) and for validating the accuracy of optimization method, the array antenna has been simulated in HFSS environment as well.

Our work is organized as follows: Section II presents the proposed EM-based optimization method. In Section III, simulation results of the optimized array antenna are described and in the final part of this paper a conclusion is presented.

II. PROPOSED AUTOMATED BUO METHOD FOR DESIGNING HIGH-PERFORMANCE ARRAY ANTENNAS

In this section, detailed descriptions of the different steps for designing and optimizing array antennas are explained. The proposed methods use the BUO scheme for automatically optimizing high performance array antennas starting with designing a single antenna. The automation consists of creating a co-operation between ADS and MATLAB [15].

Firstly, a single antenna in the ADS environment has been designed and optimized: the related *netlist.log* file includes detailed information of the design. Then, this file has been exported to be used by the numerical analyzer implemented in MATLAB. After this step, MATLAB handles the optimization process and ADS is working in the background providing the related simulation results of each iteration in an output file (named as *spectra.raw*). After designing the single antenna, it is considered in an array configuration. Leading dimensions are determined by applying the BUO method. This automated algorithm is based on increasing the number of single antennas sequentially to improve the gain performance and IBW. In each level of the process, to modify the results, the number of the elements is increased, having considered the obtained results from the previous simulation, until the desired design specifications are achieved. In this method which is based on EM simulation, the optimal number of single antennas with the optimal distance between them are obtained in an equispaced configuration. This method leads to a successful and reduced time-to-market optimization process for designing wideband and high-gain array antennas. The following Algorithm 1, describes in detail the proposed optimization process.

Algorithm 1 Automated design of array antennas with bottom-up optimization algorithm

Design of a single antenna

Step-1: Design and optimize a single antenna in ADS.

Preparation of an automated environment

Step-2: Prepare co-simulation environment between ADS and MATLAB.

Step-3: Extract *netlist.log* from a large signal S-parameter simulation environment in ADS for a designed single antenna.

Implementation of the Bottom-Up optimization algorithm

Step-4: To the extracted netlist of Step-3, increase the number of designed single antenna in Step-1 and iterate the distance between two single antennas.

Step-5: Run prepared co-simulation environment of Step-2 and consider the S-Parameter results generated in '*spectra.raw*' file.

Step-6: If the desired design goal is achieved, it is the end of process else go to Step-4.

III. PRACTICAL ARRAY ANTENNA DESIGN USING THE PROPOSED OPTIMIZATION METHOD

This section provides the simulation results of the designed and optimized single antenna and of an array antenna in terms of S-parameter, gain, and radiation pattern. The operation frequency band of interest is between 12.9 GHz and 14.3 GHz and for validating the related outcomes achieved from ADS, HFSS environment is used as well for comparing the results.

As the first step of the antenna design, the single antenna has been adopted from [16]. However, it has been further optimized in the ADS platform. The used substrate has the specifications as: $\tan \alpha = 0.0011$, $\epsilon_r = 3$, and the thickness is 1.52 mm. Figure 1 shows the designed single antenna and the

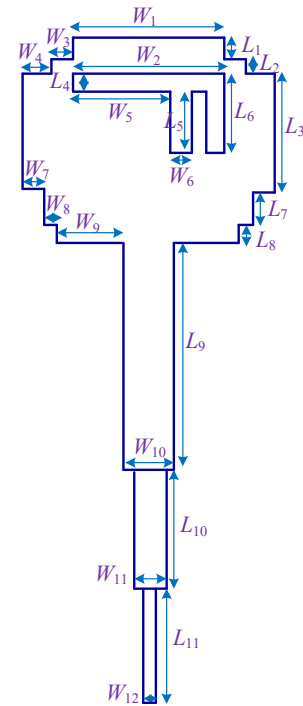

Fig. 1: Computer-aided design (CAD) model of the single antenna in ADS environment.

TABLE I: Dimensions of designed single antenna in Fig. 1

Width	Value (mm)	Length	Value (mm)
W_1	9	L_1	0.25
W_2	9	L_2	0.75
W_3	1.25	L_3	7
W_4	1.75	L_4	2
W_5	5.75	L_5	3.5
W_6	1.2	L_6	4.7
W_7	1.25	L_7	2
W_8	0.75	L_8	1
W_9	4	L_9	13.5
W_{10}	2.85	L_{10}	7
W_{11}	1.8	L_{11}	7
W_{12}	0.8		

detailed dimensions and geometry of the single antenna are presented in Tab. 1. Figure 2 presents the gain performance of the single antenna: it is less than 7.5 dB and with heavy dependence on frequency. The achieved gain is not flat and there is a noticeable decrease after 13 GHz. The radiation patterns of the single antenna for $\phi=0^\circ$ and $\phi=90^\circ$ are depicted in Fig. 3 and Fig. 4, respectively.

For having a high flat gain performance for the single antenna, we apply the proposed BUO method with EM simulations in ADS environment. By using this method, the number of optimal single antennas with the optimal distance between two consecutive antennas is achieved. Figure 5 shows the optimized antenna which is the array format of the designed single antenna in Fig. 1. In the light of BUO method, the gain performance of the single antenna has been improved and modified to be wideband and linear with respect to the impedance bandwidth as shown in Fig. 6 and Fig. 7. Figure 6

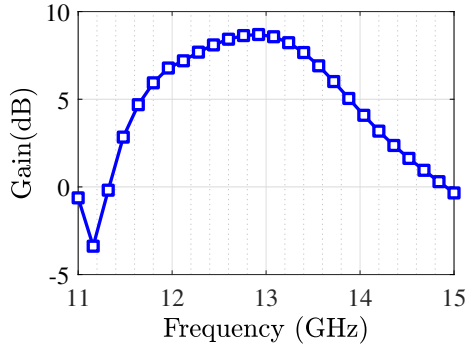

Fig. 2: Gain performance of the designed single antenna.

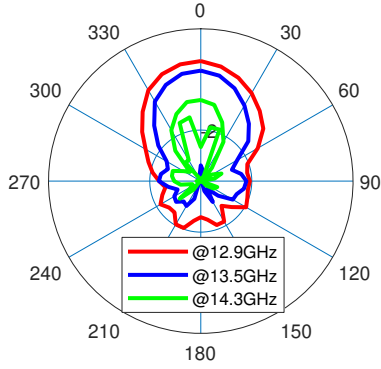

Fig. 3: Radiation pattern of designed single antenna for $\phi = 0^\circ$ at $f_1=12.9$ GHz (red), $f_2=13.5$ GHz (blue), and $f_3=14.3$ GHz (green).

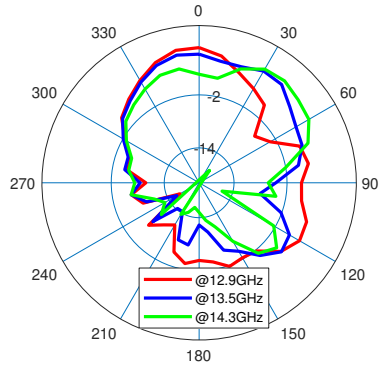

Fig. 4: Radiation pattern of designed single antenna for $\phi = 90^\circ$ at $f_1=12.9$ GHz (red), $f_2=13.5$ GHz (blue), and $f_3=14.3$ GHz (green).

depicts S_{11} simulation results of the optimized array antenna in the mentioned frequency range of 12.9 GHz - 14.3 GHz. The gain, shown in Fig. 7, exhibits a linear performance in comparison with the gain results of the single antenna. S-parameter and gain results obtained from ADS platform for the array antenna are compared with the results obtained from HFSS environment and show good agreements. The radiation pattern of the array antenna for 0° and 90° are shown in Fig. 8 and Fig. 9 respectively for three different frequencies. Three dimensional radiation patterns of the optimized array antenna is also presented in Fig. 10 at the frequency of $f = 13.5$ GHz.

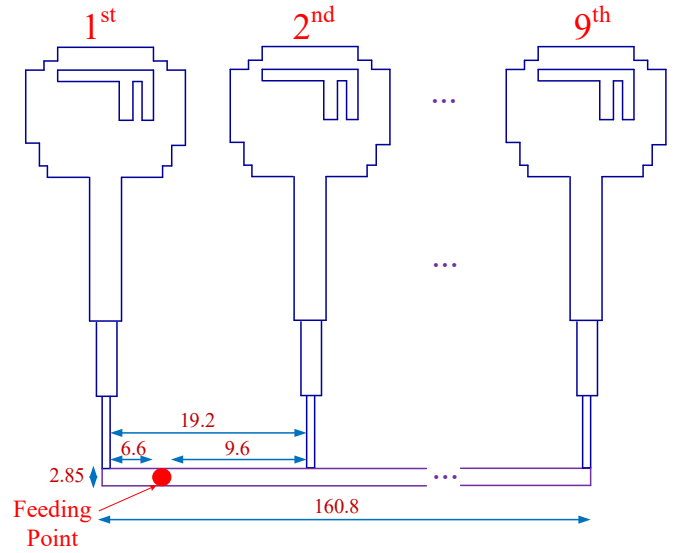

Fig. 5: Automatic EM-based optimized array antenna in ADS using BUO method; all dimensions are in mm unit. The distance between single antennas are equal.

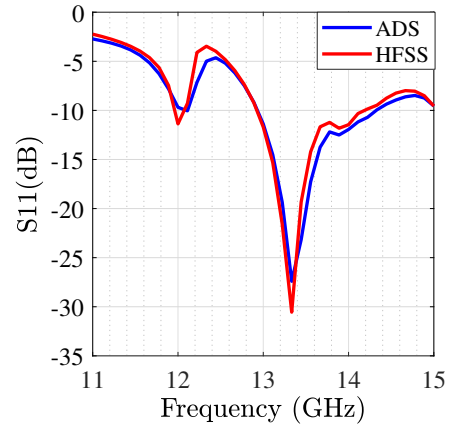

Fig. 6: S_{11} simulation results of optimized array antenna in ADS and HFSS tools.

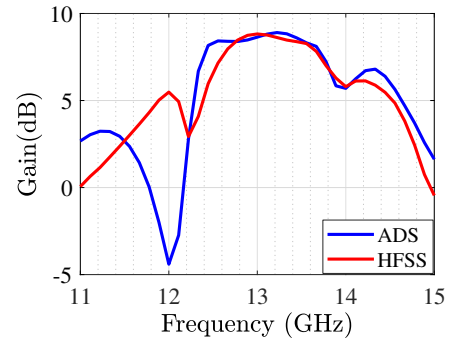

Fig. 7: Gain performance of the optimized array antenna in ADS and HFSS tools.

IV. CONCLUSION

In this work, EM-based bottom-up optimization method has been proposed to design a wideband linear high-gain array antenna in an automatic fashion. The BUO method in this

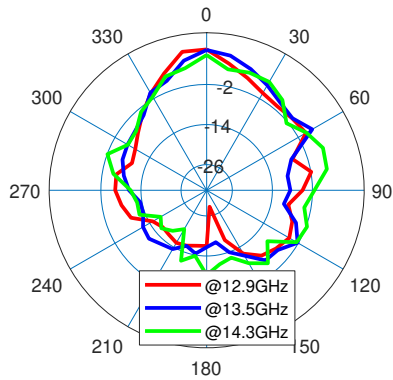

Fig. 8: Radiation pattern of optimized array antenna for $\phi = 0$ at $f_1=12.9$ GHz (red), $f_2=13.5$ GHz (blue), and $f_3=14.3$ GHz (green).

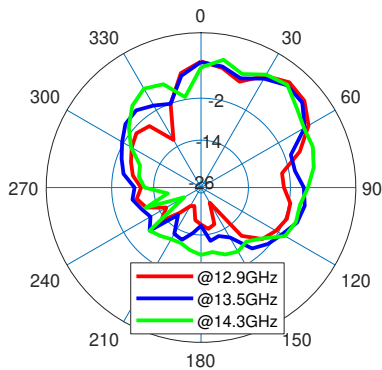

Fig. 9: Radiation pattern of optimized array antenna for $\phi = 90$ at $f_1=12.9$ GHz (red), $f_2=13.5$ GHz (blue), and $f_3=14.3$ GHz (green).

type of study, is based on increasing the number of single antennas in each stage of process and arranging the optimal distance between two single antennas to finalize the design simulation. The automated environment is used to gain benefit from design time and also improve the design reliability. After completing optimization with ADS tool, the simulation results have been also tested in HFSS environment to validate the achieved outcomes. Results achieved by HFSS depict perfectly those obtained by the means of BUO method; linear gain performance and IBW have acceptable matching. As a future study, our proposed optimization method can be improved by determining beam direction and also by considering non-equispaced configurations.

REFERENCES

- [1] G. Kwon, J. Park, D. Kim, and K. C. Hwang, "Optimization of a shared-aperture dual-band transmitting/receiving array antenna for radar applications," *IEEE Transactions on Antennas and Propagation*, vol. 65, no. 12, pp. 7038–7051, 2017.
- [2] L. Kouhalvandi, O. Ceylan, S. Paker, and H. Yagci, "Design and realization of a novel planar array antenna and low power LNA for ku-band small satellite communications," *Turkish Journal of Electrical Engineering and Computer Sciences*, vol. 25, 04 2017.
- [3] Y. Sharma, H. H. Zhang, and H. Xin, "Machine learning techniques for optimizing design of double T-shaped monopole antenna," *IEEE Transactions on Antennas and Propagation*, vol. 68, no. 7, pp. 5658–5663, 2020.

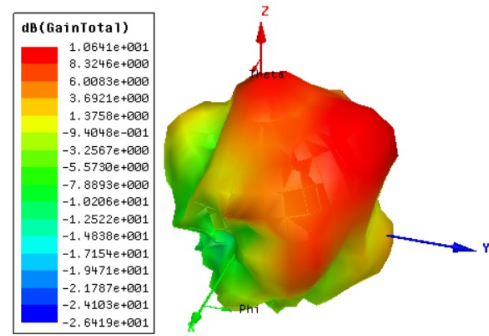

Fig. 10: 3D radiation pattern of optimized array antenna at $f = 13.5$ GHz.

- [4] R. E. Hodges, N. Chahat, D. J. Hoppe, and J. D. Vacchione, "A deployable high-gain antenna bound for mars: Developing a new folded-panel reflectarray for the first cubesat mission to mars," *IEEE Antennas and Propagation Magazine*, vol. 59, no. 2, pp. 39–49, 2017.
- [5] A. Darvish and A. Ebrahimzadeh, "Improved fruit-fly optimization algorithm and its applications in antenna arrays synthesis," *IEEE Transactions on Antennas and Propagation*, vol. 66, no. 4, pp. 1756–1766, 2018.
- [6] S. K. Goudos, Z. D. Zaharis, D. G. Kampitaki, I. T. Rekanos, and C. S. Hilaras, "Pareto optimal design of dual-band base station antenna arrays using multi-objective particle swarm optimization with fitness sharing," *IEEE Transactions on Magnetics*, vol. 45, no. 3, pp. 1522–1525, 2009.
- [7] W. Zhang, L. Li, and F. Li, "Reducing the number of elements in linear and planar antenna arrays with sparseness constrained optimization," *IEEE Transactions on Antennas and Propagation*, vol. 59, no. 8, pp. 3106–3111, 2011.
- [8] M. Lecci, P. Testolina, M. Rebato, A. Testolin, and M. Zorzi, "Machine learning-aided design of thinned antenna arrays for optimized network level performance," in *2020 14th European Conference on Antennas and Propagation (EuCAP)*, 2020, pp. 1–5.
- [9] A. R. Masoumi and N. Behdad, "Architecture, design, and nonlinear optimization of three-element biomimetic antenna arrays," *IEEE Antennas and Wireless Propagation Letters*, vol. 12, pp. 1416–1419, 2013.
- [10] N. Jin and Y. Rahmat-Samii, "Advances in particle swarm optimization for antenna designs: Real-number, binary, single-objective and multiobjective implementations," *IEEE Transactions on Antennas and Propagation*, vol. 55, no. 3, pp. 556–567, 2007.
- [11] S. Kozziel, S. Ogurtsov, W. Zieniutycz, and L. Sorokosz, "Expedited design of microstrip antenna subarrays using surrogate-based optimization," *IEEE Antennas and Wireless Propagation Letters*, vol. 13, pp. 635–638, 2014.
- [12] L. Kouhalvandi, O. Ceylan, and S. Ozoguz, "Automated deep neural learning-based optimization for high performance high power amplifier designs," *IEEE Transactions on Circuits and Systems I: Regular Papers*, pp. 1–14, 2020.
- [13] F. Passos, E. Roca, R. Castro-López, and F. Fernandez, "Multilevel Bottom-Up Systematic Design Methodologies," 07 2020, pp. 155–185.
- [14] L. Kouhalvandi, O. Ceylan, and S. Ozoguz, "Automated matching network modeling and optimization for power amplifier designs," in *2019 11th International Conference on Electrical and Electronics Engineering (ELECO)*, 2019, pp. 510–513.
- [15] L. Kouhalvandi, O. Ceylan, and H. B. Yagci, "Power amplifier design optimization with simultaneous cooperation of EDA tool and numeric analyzer," in *2018 18th Mediterranean Microwave Symposium (MMS)*, 2018, pp. 202–205.
- [16] N. M. Awad and M. K. Abdelazeez, "New UWB antenna with inverted F and U shape slots to reject WLAN and x-band applications," in *2013 7th IEEE GCC Conference and Exhibition (GCC)*, 2013, pp. 80–83.