

Multidisciplinary aircraft integration within a collaborative and distributed design framework using the AGILE paradigm

Original

Multidisciplinary aircraft integration within a collaborative and distributed design framework using the AGILE paradigm / Fioriti, M., Boggero, L., Prakasha, P.S., Mirzoyan, A., Aigner, B., Anisimov, K.. - In: PROGRESS IN AEROSPACE SCIENCES. - ISSN 0376-0421. - ELETTRONICO. - 119:(2020), pp. 1-14. [10.1016/j.paerosci.2020.100648]

Availability:

This version is available at: 11583/2854212 since: 2021-01-11T19:22:24Z

Publisher:

Elsevier

Published

DOI:10.1016/j.paerosci.2020.100648

Terms of use:

This article is made available under terms and conditions as specified in the corresponding bibliographic description in the repository

Publisher copyright

Elsevier postprint/Author's Accepted Manuscript

© 2020. This manuscript version is made available under the CC-BY-NC-ND 4.0 license
<http://creativecommons.org/licenses/by-nc-nd/4.0/>. The final authenticated version is available online at:
<http://dx.doi.org/10.1016/j.paerosci.2020.100648>

(Article begins on next page)

Multidisciplinary Aircraft integration within a collaborative and distributed Design framework using the AGILE paradigm.

Authors: M. Fioriti, L. Boggero, P.S. Prakasha, A. Mirzoyan, B. Aigner, K. Anisimov

Abstract

The aircraft design is a collaborative and multidisciplinary process. It involves several experts with different disciplinary competences. These disciplinary experts often belong to different departments or organizations. The EU funded H2020 AGILE project aims at developing new generation of Multidisciplinary Design Analysis and Optimization (MDAO) frameworks. In particular, the AGILE project tackles the investigation and the development of technologies able to enhance the collaboration between the disciplinary experts. The present paper deals with a MDAO framework developed in the context of the AGILE research project. The integration of some disciplinary expertise is described by means of a case study of an innovative regional aircraft. Some disciplinary design variables are investigated to verify the correctness of disciplines integration and to quantify the mutual dependences among the design disciplines. In particular, the variation of the engine By Pass Ratio and the electrification level of the On-Board Systems are investigated through the MDAO workflow developed for aircraft preliminary design. Finally, the results show a plausible interaction among the disciplines and interesting trends regarding aircraft systems electrification.

Nomenclature

AEA	All Electric Aircraft OBS architecture
APU	Auxiliary Power Unit
BPR	By Pass Ratio
CAU	Cold Air Unit
CFD	Computational Fluid Dynamics
COC	Cash Operating Costs
CONV	Conventional OBS architecture
DOE	Design of Experiment
dT_{eff}	Effective engine thrust losses
EAS	Equivalent Air Speed
ECS	Environmental Control System
EIS	Entry Into Service
FCS	Flight Control System
FF	Fuel Flow
FL	Flight Level
FM	Fuel Mass
FPR	Fan Pressure Ratio
$(F_x)_{wall}$	Aerodynamic force on nacelle surfaces
GTF	Geared Turbo Fan
H	Altitude
IPL	Intake Pressure Losses
I_x	Specific impulse
LG	Landing Gear
MEA1	First More Electric Aircraft OBS architecture

MEA2	Second More Electric Aircraft OBS architecture
M_d	Dive Mach number
MDAO	Multidisciplinary Design Analysis and Optimization
MLM	Maximum Landing Mass
M_{mo}	Maximum operation Mach
MTOM	Maximum Take-Off Mass
OAD	Overall Aircraft Design
OBS	On-Board System
OEM	Operating Empty Mass
OPR	Overall Pressure Ratio
Pax	Passengers
PM	Payload Mass
PIDO	Process Integration and Design Optimization
RC	Recurring Costs
SFC	Specific Fuel Consumption
T_{eff}	Effective engine thrust
T_{ideal}	Ideal engine thrust
TOFL	Take Off Field Length
TLARs	Top Level Aircraft Requirements
V_{appr}	Approach speed
V_{mo}	Maximum operational speed

1. STATE-OF-THE-ART OF MDO PROCESSES

The design of a complex system, as a new aircraft, entails the joint effort of several multidisciplinary experts. Various disciplines are therefore involved within the development process of a new aircraft, e.g. aerodynamics, structural design, propulsion, on-board systems, flight mechanics, costs and emissions assessment. The integration of various disciplines often entails contrasts and coupling effects among each other. The disciplinary optimal solutions are almost never converging to a unique one, but a balance among all the disciplines is needed to derive a global “best” solution at the entire aircraft-level. Therefore, Multidisciplinary Design Analysis and Optimization (MDAO) techniques (e.g. refer to [1], [2], [3] and [4]) are needed to overcome all the conflicts among the disciplines and to derive a solution as compromise among the disciplinary competences.

Furthermore, all the multidisciplinary expertise may not exist within a single design team. The aircraft development process might be indeed distributed among different departments and organizations to share risks and costs. Therefore, aircraft development expertise and their relative disciplinary analysis codes may belong to partners of different companies or institutions located in different nations. Therefore, the involvement of multi-national and cross-organizational design teams leads to the need of techniques supporting the collaborative design, integrating specialists and disciplinary tools and codes [5].

MDAO frameworks are required to integrate several disciplinary competences. A MDAO framework is an aircraft development environment that connects together all the involved disciplines, linking

all the simulation and design models, but also combining all the available competences. The MDAO framework is used for several aircraft design problems. Multidisciplinary Design Analyses (MDA) can be executed to assess the influences among all the involved disciplines and to determine non-optimized aircraft solutions. Moreover, MDAO frameworks are set up to investigate the design space through Design of Experiments (DOE). Eventually, optimized solutions can be achieved.

The state-of-the-art of MDAO framework is described in [6]. The design environments might be monolithic (1st generation), i.e. operated by a single design team on a local infrastructure. All the analysis modules and the optimiser are integrated within the unique monolithic system. The lack of flexibility to modify or update the implemented disciplinary models represents the main drawback of the 1st generation MDAO framework. Moreover, this kind of environment might be impracticable when several disciplines and mutual effects are considered. Otherwise, the 1st generation MDAO framework can be used for conceptual design of new aircraft, executing simple disciplinary models, quickly investigating the effects due to the integration of a limited number of disciplines [6]. Furthermore, this framework can be adopted for high-fidelity design problems [6]. A conceptual schema of this kind of framework is represented in Figure 1 (i). Examples of this type of MDAO framework are described in [7] and [8], focused on preliminary design and optimization of hybrid-electric aircraft.

Otherwise, the design frameworks might involve several disciplinary experts belonging to different organizations. Since the high complexity of the aircraft design, each organization usually focuses its research on a limited number of disciplines. The 2nd generation MDAO framework is organized to connect a distributed framework of disciplinary tools developed and owned by different experts. The 2nd generation MDAO framework is distributed as the integrated tools are held in different places. As an example of this type of MDO system, the reader could refer to the framework developed by the German Aerospace Centre DLR and presented in [9].

The 3rd generation MDAO framework (Figure 1(ii)) is an evolution of the MDAO platform. While the 2nd generation framework is characterized by a connection of different tools, the 3rd generation MDAO framework aims at involving all the disciplinary experts, who are in charge of monitoring the design process, interpreting and validating the results computed by their own codes. The 3rd generation MDAO framework includes technologies aimed at overcoming non-technical barriers [10] that might affect the collaboration among different disciplinary specialists. Therefore, the 3rd generation MDAO framework aims at overcoming all the problems concerning communication among different experts, with different skills, background, idiom and culture. Moreover, MDAO iterations usually generate a high quantity of data and results, entailing the need of automating the entire process. However, the high level of automation might bring to a lack of confidence of the MDAO results, especially in case of implementation of different disciplinary analysis codes. Only the inputs and outputs of the disciplinary analysis codes are shared among the experts, although the implemented algorithms are undisclosed, since they might be considered proprietary information. The involvement of the experts “in-the-loop” is therefore necessary to balance the automation of the MDAO process with the confidence on the results.

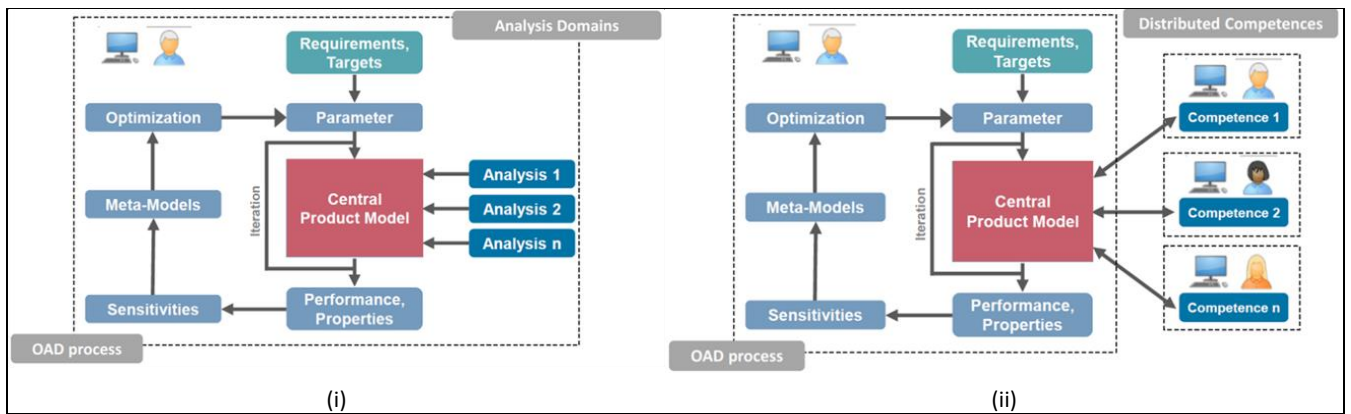

Figure 1. Evolution of MDAO frameworks [6].

Several MDAO frameworks have been developed in the last years, as PrADO [11], VADOR [12], OpenMDAO [13] and Dakota project [14]. However, these optimization frameworks don't target collaborative methodologies, as intended by the 3rd generation MDAO. Therefore, some international research projects (e.g. VIVACE [15], CESAR [16], CRESCENDO [17] and TOICA [18]) are focused on the development of processes and techniques for the enhancement of the integration of the different disciplinary experts. One of these projects, the Horizon 2020 AGILE project [19], is devoted to the development of the 3rd generation MDAO framework, which has been exploited for the present paper. The AGILE project is an EU funded initiative addressing the development of innovative MDAO processes to reduce aircraft costs and time-to-market, leading to cost-effective and greener aircraft solutions. In particular, the AGILE project targets the development of an innovative, multidisciplinary and distributed design and optimization framework, joining several specialists with different backgrounds, affiliations and disciplinary competences. The AGILE consortium has defined a development process for the setup of a collaborative 3rd generation MDAO framework. This development process starts from the elicitation of the aircraft high level requirements. Then this process collects all the available disciplinary competences and it combines the analysis tools. Successively, a MDAO problem is formulated (i.e. identifying objectives, design variables, coupling variables, constraints and other) and implemented within a Process Integration and Design Optimization (PIDO) tool (e.g. DLR's RCE [20] and Noesis' Optimus [21]). Finally, the process is concluded with the execution of the framework, determining of the MDAO solution [22].

Any MDAO process might be decomposed in three phases: setup, operational and solution phase [23]. The setup phase targets the formulation of the MDAO problem, defining the objectives of the optimization, the design variables, the required disciplinary competences and their connection. This kind of formulated MDAO problem is then implemented into a design framework, integrating all the design tools and modules in a single design environment. From the setup phase, the MDAO process moves to an operational phase, during which the system is executed. Eventually, the solution of the MDAO problem is derived (solution phase). The first ambition of the AGILE project is the acceleration of the setup phase of the MDAO process, hence reducing the development time. Indeed, it has been estimated that 60% to 80% of the project time is required to setup the MDAO process [6]. This objective can be effectively achieved by deploying distributed, cross-organizational MDAO processes. Therefore, a second goal of the AGILE project targets the support of the collaborative design, integrating specialists and disciplinary tools. Eventually, the AGILE consortium targets the exploiting of the potentials offered by the latest technologies in collaborative design and optimization [24].

This paper would aim to prove the enhancement given by the 3rd generation MDAO proposed within the AGILE research project. In particular, the interaction between the main disciplinary analyses carried out within the project is described. Great importance is given to the specific studies needed by the experts involved to demonstrate the correctness of tools integration by means of small DOE. At the same time, these specific analyses are needed by the experts to understand the results obtained during the next MDO studies which usually produce a large quantity of results that could not be easily understood and accepted by each expert. In this article, the analyses regarding engine By-Pass Ratio (BPR), On-Board Systems (OBS) level of electrification and nacelle shape are described as demonstration of proper disciplines integration. These analyses contributed to improve the knowledge of the involved experts so as to improve their ability to judge the results and to have an active role in the MDAO process.

2. INTRODUCTION OF INTERDISCIPLINARY AND MULTIFIDELITY FRAMEWORK FOR REGIONAL JET AIRCRAFT DESIGN

The focused framework is a task of the AGILE project carried out to investigate the integration of more than one complex systems [25], [26] and [27]. In aircraft design, the airframe, propulsion system and OBS design are complex disciplines that should be integrated and optimized together. Different technical solutions have been analysed for each involved discipline to evaluate the effects on local optimizations. In particular, the main aim is the assessment of the effects of engine BPR and OBS architecture on the Overall Aircraft Design (OAD). Local optimizations regarding the definition of the OBS architecture, engine design and geometry and position of engine nacelle have been performed.

The design space of the DOE investigation is defined by the following variables:

- Engine BPR (3 discrete levels)
- OBS electrification degree (4 discrete levels)
- Nacelle shape (18 local variables) and position (5 local variables)

These variables will be further described in the following subsections.

Figure 2 depicts the design workflow that is specifically developed to investigate the integration of the engine, OBS and nacelle design disciplines within an OAD process. In Table 1, the main coupling variables (i.e. variables exchanged by disciplinary analyses) of the proposed workflow are listed to better illustrate the interaction of each disciplinary module. The design process is iterative, as a convergence on the Maximum Take Off Mass (MTOM) should be achieved. In other words, at the end of each iteration, a new value of MTOM is obtained on the basis of the results derived from each discipline involved in the process. In a converging design problem, this updated value evolves to a constant result, which identifies the solution. The proposed workflow encompasses the basic disciplines involved within a common OAD process. Each disciplinary module is located in a different computer owned by a different partner of the AGILE consortium, hence realizing a distributed framework. Each disciplinary expert can supervise and control the operations of his own module. The "Aircraft Synthesis" module evaluates the aircraft aerodynamic performance and computes the loads acting on the airplane during different mission conditions – e.g. takeoff, cruise and landing – and eventually designs the aircraft structure and geometry. This discipline is implemented within

VAMPzero [28], a tool developed and retained in DLR. VAMPzero receives as input the Top Level Aircraft Requirements (TLARs), the mission profile and several other results assessed by the other design competences during the previous iterations, e.g. the required fuel mass, engine and OBS masses and the aerodynamic characteristics of engine nacelle (see Table 1). However, during the first iteration, these inputs cannot be obtained from the other design modules integrated in the workflow. In this case, these values derive from a converged aircraft conceptual design, which is executed employing lower-fidelity design tools (see section 3). Other than the main aerodynamic results, as the aircraft drag, “Aircraft Synthesis” module estimates the structure masses, which contribute to the determination of the Operating Empty Mass (OEM). In addition, a new value of MTOM is estimated on the basis of the required fuel mass and the payload required by the customer. The computed aerodynamic drag is then transferred in terms of required thrust to the second module of the workflow related to the design of the aircraft engine. The engine module is based on GasTurb software [29] employed by the experts of the Russian Engine Research Centre (CIAM) and it is conceived to consider the influences of nacelle geometry, too. This competence mainly evaluates the engine mass, Fuel Flow (FF) and Specific Fuel Consumption (SFC) along the entire mission profile. These parameters close the first loop with “Aircraft Synthesis” module, which redesigns the aircraft according to the new engine. The engine performance is indeed affected by the OBS power offtakes, which are computed within the third module (ASTRID [30], [31]), developed and held by Politecnico di Torino. Moreover, this module estimates the OBS masses and the volumes of the main equipment. It requires as input the MTOM, OEM and fuel mass, aircraft geometry, some engine competence results (i.e. FF and high pressure shaft speed) and the aircraft mission profile (see Table 1). It is worth noting the second internal loop between the OBS and the engine design competences. The new OBS power offtakes that also depend from engine performance are used by GasTurb to redesign the engine. The first and the second internal loops of the proposed workflow (see Figure 2) have been introduced considering the huge difference in terms of computational time between the nacelle design module, located in the Russian Aerodynamics Research Centre (TsAGI), and the other modules. Since the nacelle design requires a computational time greater than an order of magnitude compared with the other modules, the introduction of the two internal loops reduces the OAD convergence time. Once the engine and the OBS tools have been executed and the design is internally converged under the experts’ supervision, the obtained results are transferred to the nacelle design module. The engine and aircraft geometries and performance are used to complete a CFD analysis of the engine nacelle. The module locally optimizes the shape of the nacelle and its position related to the wing and fuselage with the objective of minimizing its aerodynamic drag and avoiding a decrease of engine performance. Moreover, the engine and OBS masses update the aircraft OEM. The fuel mass computed in the “Mission Simulation” module, which is located in DLR, together with the required payload and the new value of OEM is conveyed to the first module of the workflow to derive the updated MTOM. This module uses all the information concerning the aircraft aerodynamics, engine performance and mission profile. Once the convergence has been reached, the design process ends with the evaluation of emissions and costs by means of the last module of the workflow developed and stored in Aachen Technical University (RWTH). This module collects as input the aircraft mass breakdown and basic aircraft and engine performance characteristics.

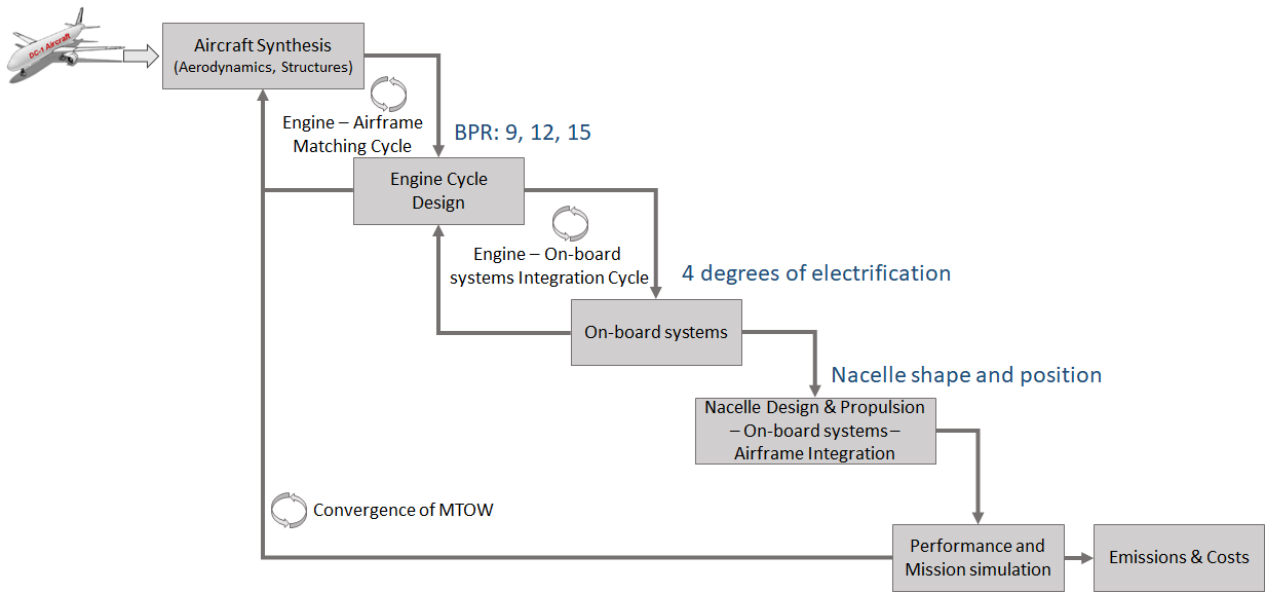

Figure 2. AGILE Multidisciplinary Analysis Integration OAD Workflow

Table 1. Main inputs, outputs and coupling variables (in bold) for each module of the multidisciplinary workflow proposed

Disciplinary Module	Input	Output
Aircraft Synthesis	TLARs Mission profile Fuel mass Engine mass OBS masses Integrated nacelle aerodynamics Conceptual design results	Load analysis Aircraft aerodynamic performance Aircraft structure masses Aircraft MTOM, OEM Aircraft geometry
Engine Cycle Design	Thrust requirements OBS power offtakes Nacelle geometry	Engine mass Engine geometry Engine performance
OBS Design	Aircraft geometry Engine performance Mission profile Aircraft MTOM, OEM	OBS masses OBS volumes OBS power offtakes
Nacelle design and propulsion system airframe integration	Aircraft geometry Mission profile Engine performance Engine geometry	Integrated nacelle aerodynamics Nacelle mass Nacelle geometry
Mission simulation	Aircraft aerodynamic performance Engine performance Mission profile	Fuel mass Aircraft performance Thrust requirements
Emission and cost	Aircraft structure masses Fuel mass Engine mass OBS masses Thrust requirements Engine performance	Aircraft noise and pollutant emissions Aircraft operating cost

The present section ends with the description of the design variables of the three disciplines of which influences on the OAD process are investigated in this article. Several design cases are presented in section 3, focused on the AGILE project reference aircraft.

2.1. Engine BPR design variable

In the present design space, three different values of engine BPR are defined: 9, 12 and 15. This engine parameter was selected due to its importance for engine SFC and engine mass, which directly affect the fuel required by the aircraft to complete the defined mission profile.

In general, optimal engine cycle parameters (such as BPR, Overall Pressure Ratio – OPR, Fan Pressure Ratio – FPR, etc.) and engine size are defined during Engine /Aircraft matching process. As only BPR was adopted in the project as global design variable, optimized under accepted criteria, other engine cycle parameters were defined based on the prototype engine parameters and local optimization. Figure 3 shows the typical results of local optimization of FPR depending on BPR and engine installation losses considered in the view of dependences of uninstalled and installed cruise SFC on BPR at different fixed FPR (black lines). Black lines “I” correspond to uninstalled SFC values, “II” – SFC including intake pressure losses (IPL), “III” – SFC including IPL + power offtakes, “IV” – SFC including IPL, power offtakes + nacelle drag. Lower blue line represents dependence of minimal uninstalled cruise SFC and corresponding optimal FPR on BPR, upper blue line represents same dependence for installed cruise SFC. Red dashed arrow indicates change of optimal BPR and FPR if installed SFC is taken into account instead of uninstalled SFC. The increment of engine mass and nacelle drag and the decrease of SFC (i.e. fuel mass) are two opposite effects of increment of engine BPR that have to be evaluated at aircraft level by means of the aircraft MDAO framework.

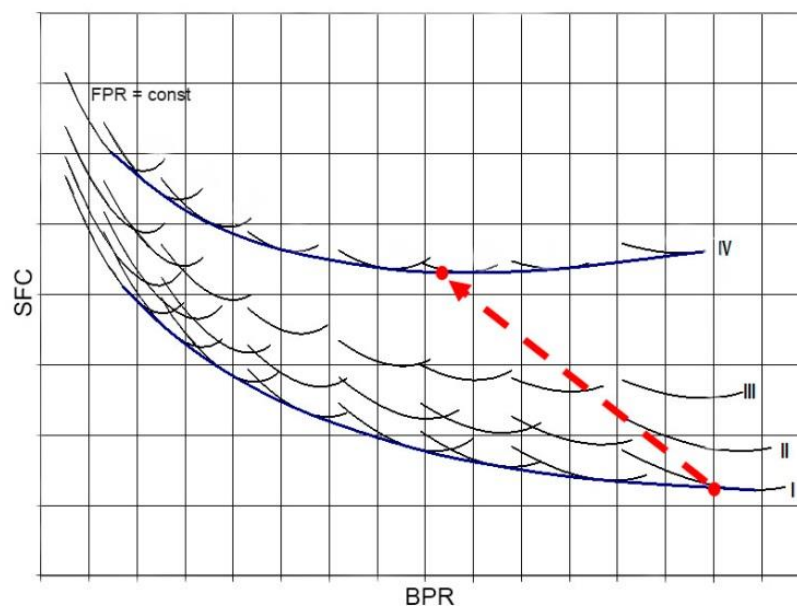

Figure 3. Dependences of uninstalled and installed cruise SFC on BPR at different FPR.

2.2. On-board Systems architecture design variable

The second design variable defined is the electrification level of the aircraft OBS, which is meant as the ratio between the electric power produced by innovative architecture over the electric power produced by conventional architecture. With the aim of improving the OBS efficiency and maintainability and reducing their mass, a new trend toward the adoption of OBS with an increasingly level of electrification [32], [33] is envisaged. Therefore, four OBS architectures with different level of electrification are considered in the present study. These are representative of the several OBS architectures that can be designed [34], [30]. The main assumptions and design guidelines are here described:

- Conventional (Conv): the conventional OBS architecture is the state-of-the-art that uses electric, hydraulic and pneumatic users. The electric and hydraulic power are provided by electric generators and hydraulics pumps connected to the accessory engine shaft. The pneumatic users are powered by the compressed air bled from engine compressor.
- More Electric n.1 (MEA1): starting from the conventional architecture, an intermediate level of electrification is defined for the more electric one. All hydraulic users as control surfaces and landing gear actuators are removed and replaced by electric ones. Therefore, all hydraulic pumps attached to the engine are removed.
- More Electric n.2 (MEA2): the OBS architecture is totally redesigned increasing the level of electrification. The system users considered in the conventional architecture are still present, but the generation system is only electrical. The hydraulic power and the pneumatic power are obtained by respectively electric driven hydraulic pumps and dedicated air compressors driven by electric motors [33].
- All Electric (AEA): the all-electric architecture combines the innovative features of the more electric configurations (i.e. MEA1 and MEA2). The power generation is totally electrical and the hydraulic users are removed [35]. The Environmental Control System (ECS) is electrified, as it is powered by dedicated electric air compressors. Removing the use of hydraulic oil and removing the hot pipes of the traditional ECS, the AEA configuration also increases the safety level of the aircraft [36].

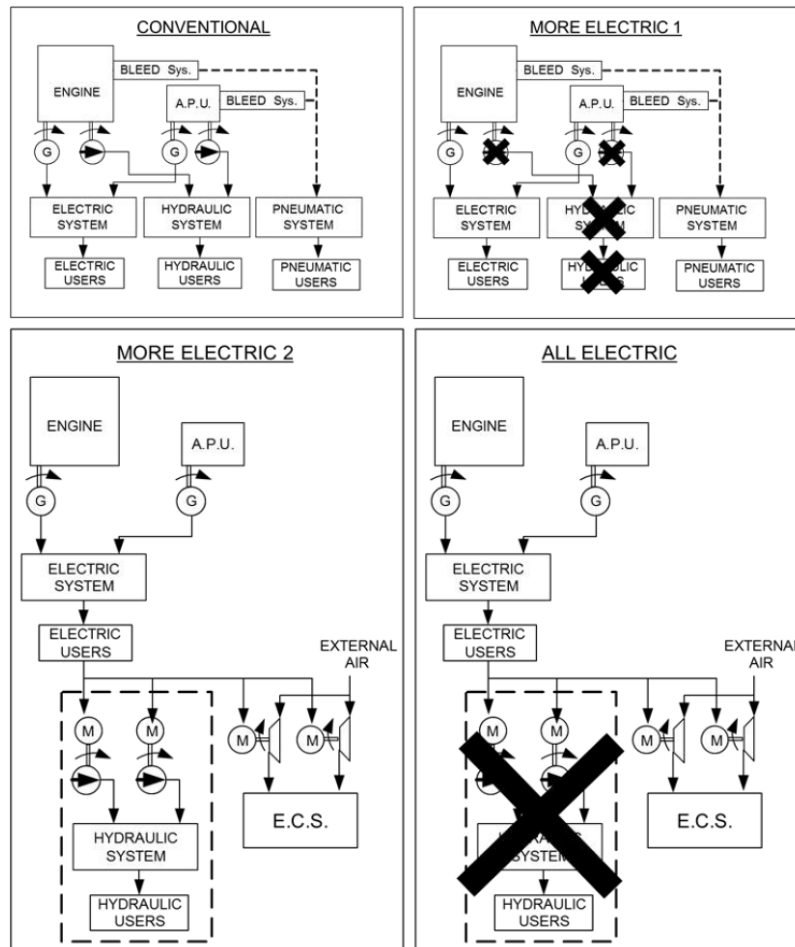

Figure 4. OBS architectures with different electrification level.

For each architecture, different masses and different power offtakes are obtained using ASTRID tool. Regarding OBS mass, different components as actuators, electric generators, converters and different power generation and distribution systems are considered for each architecture. Therefore, changing the OBS electrification level, different values of the OBS mass are obtained. In the same way, the OBS power extracted from the engines is different when a different architecture is considered. The difference is both in terms of absolute value and typology of power. In particular, some architectures require only mechanical power from engine shaft, others require bleed air from engine compressor, too. It is also important to consider the different effect on engine performance when different typology of power is required by OBS. Specifically, the bleed air required by engine compressor is usually more detrimental to engine SFC than the mechanical power [37], [38]. Therefore, in the proposed workflow the output from the OBS module is reused to recalculate the engine performance and to take into account the new OBS masses in the aircraft synthesis module.

2.3. Nacelle design and position design variable

The last design variables are related to engine nacelle design and integration. Inside the respective modules, a local optimization is considered for both nacelle design and nacelle position. Both the optimisations are carried out by using SEGOMOE optimization algorithm [39]. The optimisations are made for cruise regimes (Mach number $M = 0.78$, Altitude $H = 11000\text{m}$). Reynolds-Averaged Navier–Stokes calculations with shear stress transport model of turbulence are made to obtain results for

each variant of nacelle geometry and position. The objective function for both nacelle geometry and nacelle position optimisations is the minimization of the effective thrust losses (dT_{eff}). dT_{eff} is defined as follows:

$$dT_{eff} = 1 - \frac{T_{eff}}{T_{ideal}}$$

where:

T_{ideal} represents the ideal engine thrust;

$T_{eff} = (I_x)_{in} - (I_x)_{out} + \sum (F_x)_{wall}$ is the effective engine thrust.

T_{eff} is calculated as a sum of the aerodynamic loads on nacelle surfaces $(F_x)_{wall}$ plus the difference between the input $(I_x)_{in}$ and output $(I_x)_{out}$ pulses. All values are projected to flow axis (i.e. x-axis in Figure 5).

Nacelle optimisation is carried out considering engine dimensions, engine gas properties and aircraft mission profiles (in terms of speed and altitude). The optimization of the nacelle shape is carried out with the aim of reducing the loss of engine performance due to its installation. The methodology for determination of internal and external characteristics of engine nacelle corresponds to the procedure described in [40]. The isolated nacelle geometry is optimized using the 18 geometrical design variables shown in Figure 5 and described in [41] in more details.

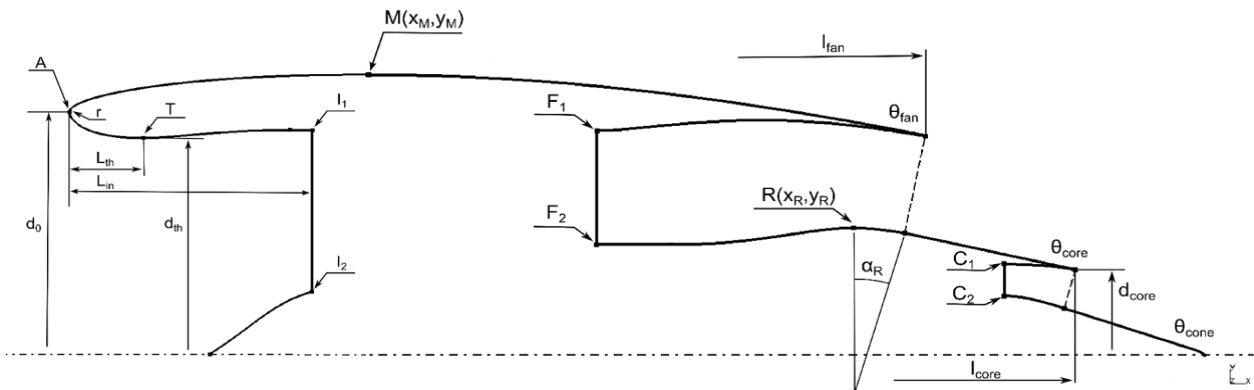

Figure 5. Isolated nacelle optimization variables [41].

Figure 6 shows the second step of local optimization (i.e. the nacelle installation). The optimization is performed considering the position of engine nacelle within an x, y, z global reference system and its angular orientation. The angles are defined considering the nacelle axis of symmetry and y-axis (α angle) and z-axis (β angle). As previously introduced, the local optimization process is performed considering as objective function the reduction of losses of the engine due to its installation on aircraft. Outer aerodynamic loads are calculated integrating the pressure and friction forces acting on the nacelle surface. Since the ideal thrust T_{ideal} and the input and the output pulses are constant from practical point of view, the engine nacelle drag is minimized during the second step of optimization.

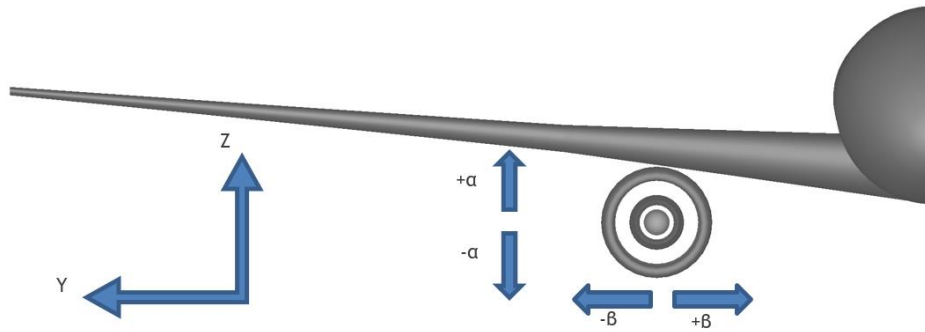

Figure 6. Engine nacelle position variables.

3. AGILE REFERENCE AIRCRAFT

The design workflow presented in section 2 is now executed to analyse the influence on the OAD process of the design variables previously described. The AGILE project reference aircraft is considered as case study. It consists of a 90 passenger regional turbofan aircraft characterized by the TLARs listed in Table 2. The aircraft is considered to be conventional (i.e. “wing and tube” configuration) and the reference engine is the PW1700G geared turbofan.

Table 2. Reference regional turbofan TLARs.

Conventional Large Regional Jet Reference Aircraft (EIS: 2020)	
Range	3500 km
Design payload	9180 kg
Max. payload	11500 kg
Num. of passengers	90 pax @ 102 kg
MLM (% MTOM)	90%
Long Range Cruise Mach	0.78
Initial Climb Altitude	11000 m
Maximum Operating Altitude	12500 m
Residual climb rate	1.5 m/s
TOFL (ISA, SL, MTOM)	1500 m
V _{appr} (ISA, SL, MLM)	67 m/s
Max. operation speed (V_{mo} / M_{mo})	170 m/s / 0.82
Dive Mach number (M_d)	0.89
Fuselage diameter	3 m
Fuselage length	34 m
Service life	80,000 cycles
Fuel reserves	5%
A/C configuration	Low-wing, wing-mounted engines
Engine	Reference PW1700G

This set of TLARs drove the aircraft conceptual design previously performed to define the first solution. This solution represents an initial baseline for the design process implemented by the

workflow previously discussed. This very preliminary aircraft initialization has been performed through low-fidelity analysis codes. The employed workflow for conceptual design is depicted in Figure 7 [42]. The detailed description of the workflow is out of the scope of the present article, but part of the obtained results is collected in Table 3, which brings to the aircraft layout sketched in Figure 8.

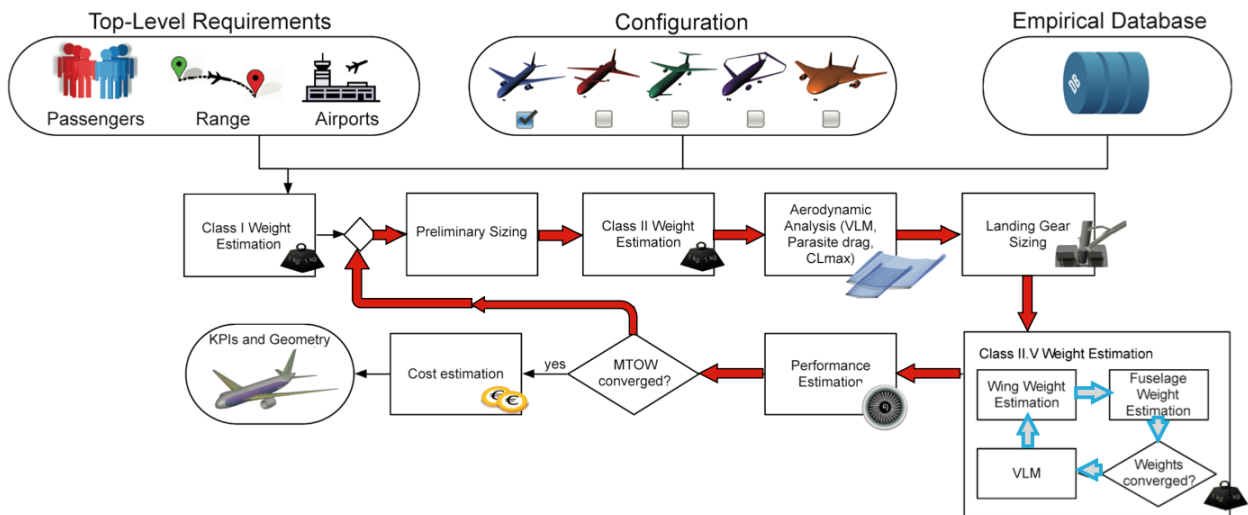

Figure 7. Conceptual design workflow [42].

Table 3. Aircraft masses and engine performance results from conceptual design workflow.

Aircraft masses	
Payload Mass (PM)	11500 kg
Operating Empty Mass (OEM)	25989 kg
Fuel Mass (FM)	8100 kg
Maximum Take-Off Mass (MTOM)	45589 kg
Engine performance	
Maximum Take-Off thrust	82 kN

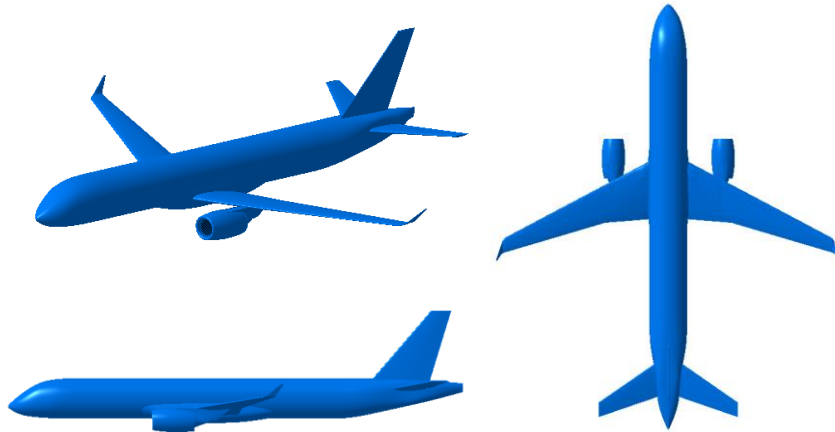

Figure 8. Reference aircraft three views.

From the results of the conceptual design, a new baseline is derived by means of the preliminary design workflow depicted Figure 2. This solution is characterized by engines with BPR 12 and a conventional OBS architecture. The obtained results are listed in Table 4. It can be noted that the resulting parameters slightly differ from those previously shown, as the fidelity level of the disciplinary codes employed in this new design process is higher. The obtained baseline is used to quantify the impact of the disciplinary design variables – i.e. engine BPR and OBS electrification degree – in terms of aircraft masses and costs, as described in section 4.

Table 4. Reference aircraft masses and engine performance.

Aircraft masses	
Payload Mass (PM)	11500 kg
Operating Empty Mass (OEM)	23965 kg
Fuel Mass (FM)	7867 kg
Maximum Take-Off Mass (MTOM)	43332 kg
Engine performance	
Maximum Take-Off thrust	78 kN

4. INFLUENCE OF THE DESIGN VARIABLES ON AGILE REFERENCE AIRCRAFT

Starting from the aircraft baseline and performing a Multidisciplinary Design Analysis (MDA) for each design variation defined in subsections 2.1, 2.2 and 2.3, notable disciplinary results are obtained. In particular, the main outcomes are the assessment of the influence of engine BPR and OBS electrification on the OAD. It is worth noting that the accomplished study and all the proposed results came from a converged MDA. Therefore, the effects of the iterative process to obtain a converged design (i.e. snowball effect) are accounted.

4.1. The influence of engine BPR on OAD

As introduced in subsection 2.1, the engine BPR has a remarkable effect on aircraft design. In particular, using the preliminary design workflow (see Figure 2), it is possible to evaluate the impact on engine SFC, engine mass and total fuel required. In Figure 9, Figure 10 and Figure 11 are respectively depicted the variations of engine installed SFC, fuel flow and specific thrust in typical takeoff, climb/descent and cruise flight conditions (Equivalent Air Speed - EAS and Flight Level - FL). The increase of engine BPR produces a reduction of engine SFC and fuel flow in all phases of the aircraft mission profile. However, the increment of BPR reduces the engine specific thrust and increases the engine cross section (i.e. fan diameter) and the engine mass (see Table 5).

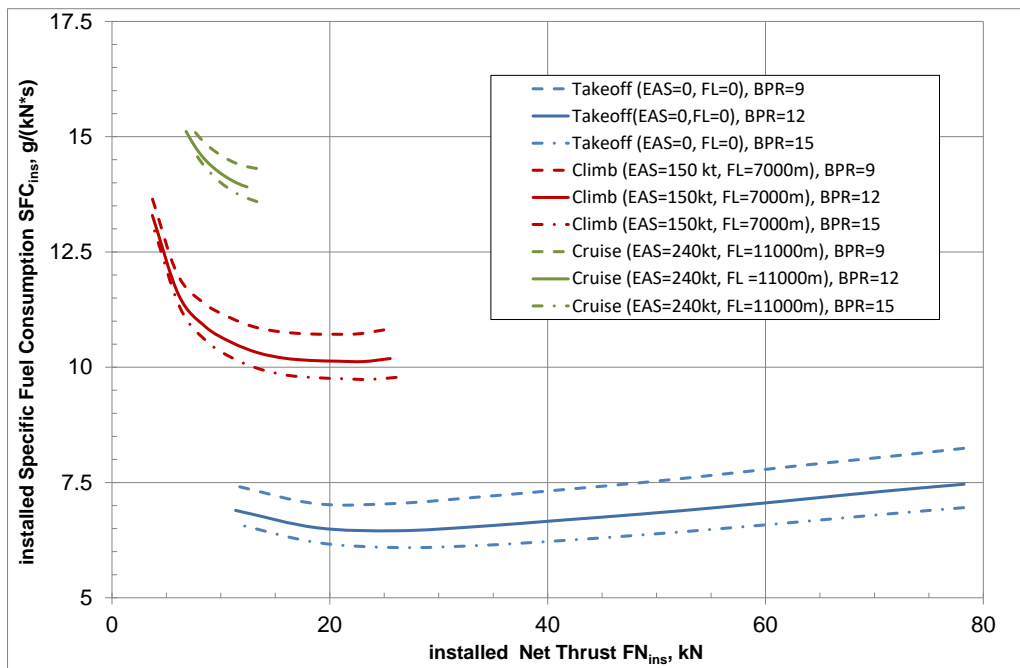

Figure 9. Impact of BPR on the engine throttling map (installed SFC_{ins} vs. installed engine thrust FN_{ins}) at typical takeoff, climb/descent and cruise flight conditions for GTF with conventional OBS.

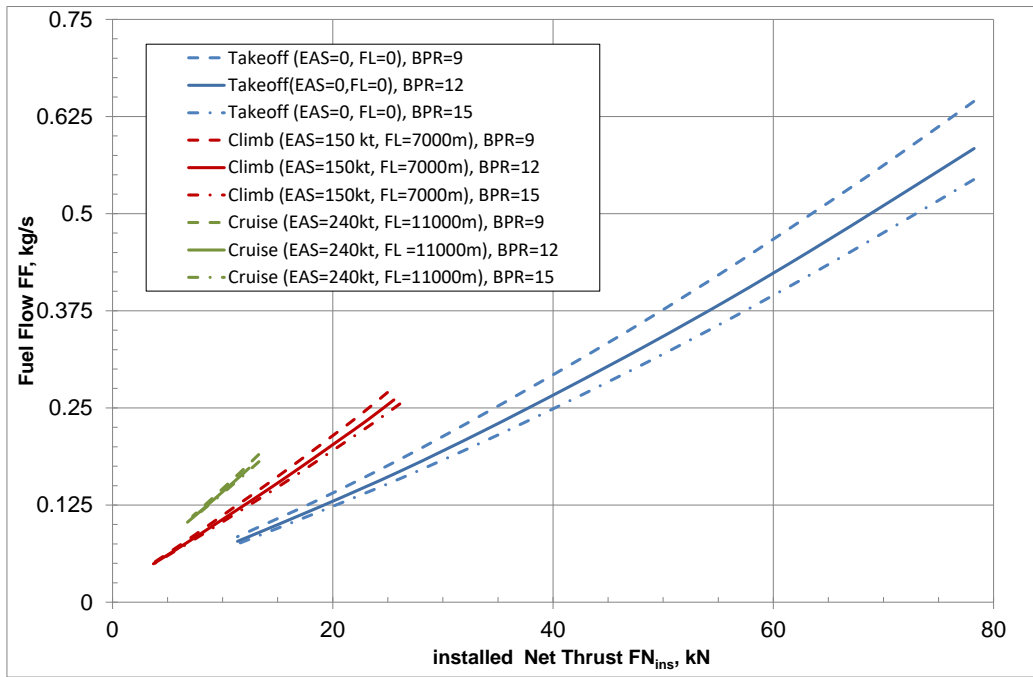

Figure 10. Impact of BPR on the engine throttling map (engine Fuel Flow FF vs. installed engine thrust FN_{ins}) at typical takeoff, climb/descent and cruise flight conditions for GTF with conventional OBS.

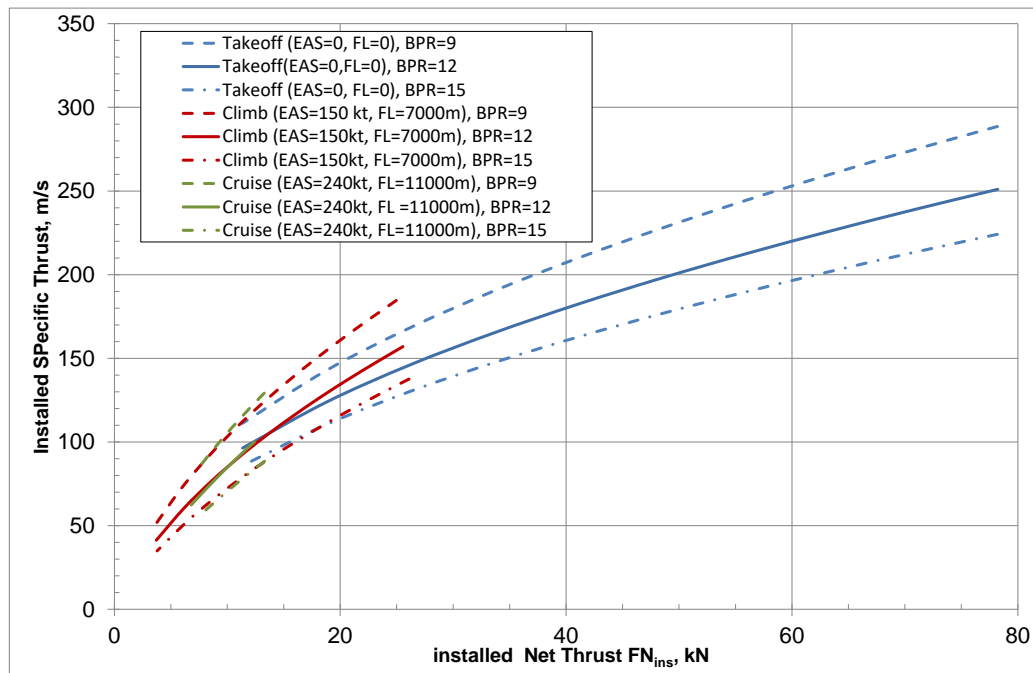

Figure 11. Impact of BPR on the engine throttling map (installed Specific Thrust vs. installed engine thrust FN_{ins}) at typical takeoff, climb/descent and cruise flight conditions for GTF with conventional OBS.

Table 5. Engine specifications for different BPR.

Engine specification	Engine baseline	Engine with Lower BPR	Engine with Higher BPR
BPR	12	9	15
Min SFC in cruise condition [g/kN s]	13,9	14,25	13,6
Max specific thrust [m/s]	250	290	225
Fan diameter [m]	1,54	1,40	1,67
Mass [kg]	1190	1110	1300

Focusing on the overall aircraft, the main effects produced by engine BPR are the change of fuel required during the mission and the change of aircraft OEM. As shown in Table 6, the engine with a BPR equals to 12 is the best option among those investigated since it entails the lowest aircraft MTOM. Decreasing BPR of 25% (i.e. BPR = 9), the OEM decreases of 0.45% because of the saving in engine mass. On the other hand, the fuel required increases of roughly 3.5% due to the greater SFC of this engine option. Increasing the BPR of 25% (i.e. BPR = 15), an increment of OEM due to a greater engine mass can be observed. In contrast, a greater BPR improves the propulsive efficiency reducing the necessary fuel mass despite the additional drag due to the greater nacelle. In Figure 12, the trends of the OAD masses (i.e. FM, OEM and MTOM) are shown. Since the number of BPR cases is relatively low, the results of the interpolation are only qualitative. However, the MTOM curve correctly shows the balancing of the saved fuel mass and the increase in OEM for the baseline BPR.

Table 6. Effects of engine BPR on OAD in absolute terms and in relative terms respect to the baseline (BPR = 12).

Aircraft main specifications	Engine baseline	Engine with Lower BPR	Engine with Higher BPR
Payload Mass [kg]	11500	11500	11500
Fuel Mass [kg]	7867	8139	7790
variation compared to baseline [%]	-	+3.46	-0.98
Operating Empty Mass [kg]	23965	23857	24249
variation compared to baseline [%]	-	-0.45	+1.19
Maximum Take-Off Mass [kg]	43332	43496	43539
variation compared to baseline [%]	-	+0.38	+0.48
Design variables			
Engine BPR	12	9	15
variation compared to baseline [%]	-	-25	+25
OBS architecture	Conv	Conv	Conv

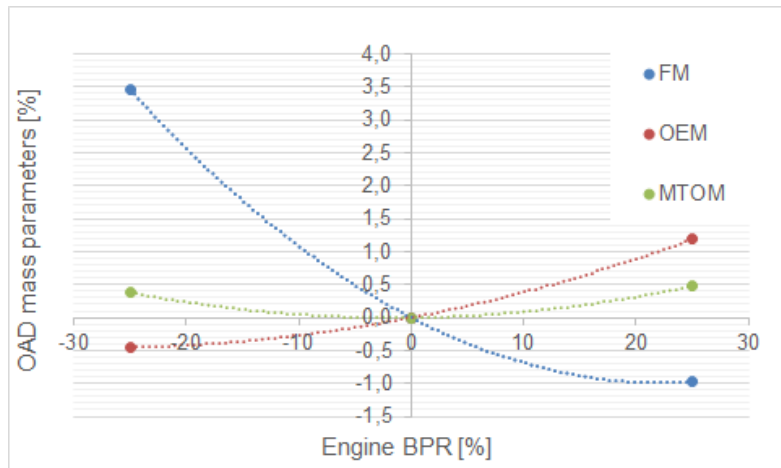

Figure 12. Main OAD masses trend with engine BPR.

Another important result given by the presented multidisciplinary framework is the estimation of the aircraft recurring and operating costs of each engine option. In Figure 13 are plotted the Recurring Costs (RC) on the left, and Cash Operating Costs (COC) on the right hand side. The numbers are given in percentages with respect to the BPR = 9 engine as a baseline. It can be depicted from the figure that RC increase by about 0.7 % from BPR = 9 to BPR = 12 and again by about 1 % from BPR = 12 to BPR = 15. This is mainly caused by an increase in engine mass that results from the higher BPR. On the other hand, the COC (see Figure 13 ii) decrease by almost 2% from BPR = 9 to BPR = 15 due to the higher engine efficiency – and thus lower fuel burnt during the mission – that comes with an increased BPR. As for the absolute cost numbers, this means that the RC are overcompensated by the operational savings after one year of operations when moving from BPR = 9 to BPR = 12. When moving from BPR = 12 to BPR = 15, the operating costs do not significantly decrease further compared to the large increase in RC for the BPR = 15 engine. Therefore, from an overall cost perspective, the BPR = 12 engine appears to be the preferable concept for further investigations. Please note that these numbers apply taking into account a utilization of the aircraft of 1500 flights per year.

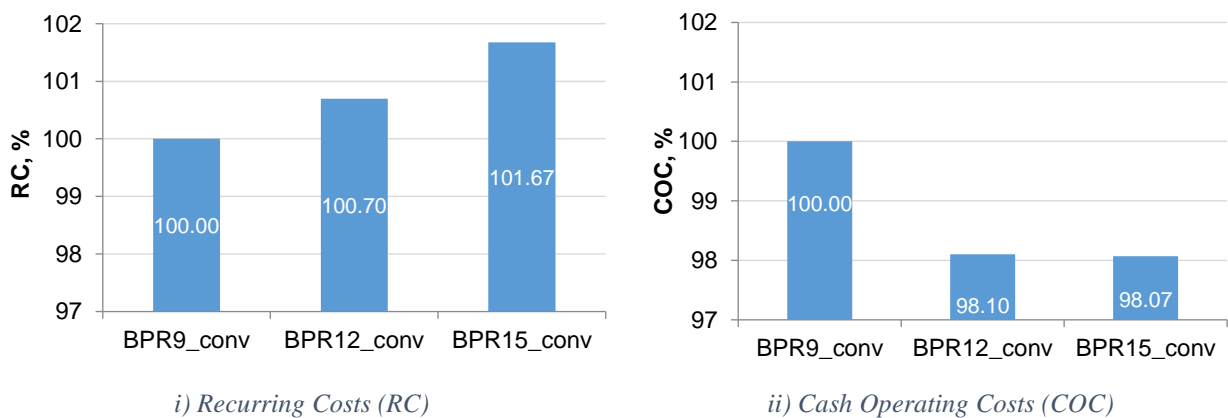

Figure 13. RC and COC for three different engine BPR

4.2. The effect of OBS electrification on engine performance and OAD

The four OBS architectures are designed starting from the OAD aircraft data. Each architecture has a different level of electrification as specified in subsection 2.2. Since their different architectures and main equipment, each architecture has a different mass and different power offtakes that are respectively listed in Table 7 and Table 8.

Table 7. Mass breakdown for each OBS architecture.

System Masses [kg]	Conv	MEA1	MEA2	AEA
Avionic	617	617	617	617
FCS	572	743	572	743
LG	1308	1336	1302	1336
ECS and anti-ice	650	649	617	617
Fuel System	380	380	379	379
Aux Power System	173	172	172	172
Furnishing System	2209	2209	2208	2207
Hydraulic	499	0	357	0
Electric	784	839	999	1032
Total Systems Mass	7191	6945	7222	7103
Relative variation compared to conv. OBS architecture [%]	-	-3.43	0.43	-1.23

Regarding the OBS masses, it is worth noting that some OBS are not affected by the electrification level. The avionic, fuel, furnishing systems and the Auxiliary Power Unit (APU) are not directly involved in the OBS electrification. Some of the main components of these systems can only be electrically supplied (e.g. fuel pumps, avionic equipment) whereas others cannot be easily electrified (e.g. air conditioning distribution and APU). The mass of these OBS is slightly different because of their dependence on MTOM, which changes slightly with the OBS electrification level. The mass variation of the other OBS, for each architecture, can be summarised as follows:

- Flight Control System (FCS): usually the hydraulic actuators, used in Conv and MEA2 architectures, are less efficient and with a lower level of maintainability [43] but lighter than the electric actuators used in MEA1 and AEA architectures. The electric actuators have more components and, in general, they are more complex than the hydraulic ones.
- Landing Gear (LG): as for FCS, hydraulic or electric actuators are used for the actuation system of the LG.
- Environmental Control System (ECS): the Conv and MEA1 architectures use the traditional bleed system to power the ECS. In this case, some heavy pneumatic pipes connect some engine compressor stages to the Cold Air Unit (CAU). The MEA2 and AEA adopt the bleedless pneumatic system that is lighter than the conventional one since it removes the heavy pipes. However, the bleedless ECS uses some dedicated air compressors driven by electric motors that partially lessen the save in ECS mass.
- Electric and Hydraulic Power System: as showed in Table 7, the OBS architectures which rely on more electrified equipment have a heavier electric system but a lighter (or totally removed) hydraulic system. In particular, the MEA2 is a more electric configuration that still uses the hydraulic system to power the FCS actuators. The MEA1 and AEA do not adopt any hydraulic equipment and the related power system can be totally removed. Moreover, the increase of electric system mass is not proportional with the increase of the electric power

generated because of the adoption of high voltage technology and new electric distribution architecture [33], [35].

Concerning the power required by the OBS, the data listed in Table 8 and shown in Figure 14 is related to the mechanical power required by electric generators and hydraulic pumps and the pneumatic power required by the different OBS architectures calculated in the different phases of the mission profile. It is worth noting that Conv and MEA1 architectures show similar results. The shaft power required by MEA1 is slightly lower than Conv due to the more efficient electrical FCS. MEA2 and AEA adopt the bleedless architecture, hence no pneumatic power is required from the engine. However, all secondary power needed by OBS is taken from engine shaft through more powerful electric generators. Also in this case, the slight difference between the mechanical power offtake of MEA2 and AEA is due to the different FCS technology. In general, the bleedless architectures require less power from the engine.

Table 8. Total power offtakes for each OBS architecture within the mission profile.

FLIGHT SEGMENTS	Conventional Aircraft		MEA 1		MEA 2		AEA	
	mechanical offtake [kW]	bleed air [kg/s]	mechanical offtake [kW]	bleed air [kg/s]	mechanical offtake [kW]	bleed air [kg/s]	mechanical offtake [kW]	bleed air [kg/s]
Take off	60.91	0	57.83	0	60.91	0	57.83	0
Climb	72.86	1.21	70.10	1.21	160.88	0	158.12	0
Cruise	72.71	0.80	69.95	0.80	200.22	0	197.47	0
Descent	72.89	1.21	70.14	1.21	160.91	0	158.15	0
Approach	84.72	1.56	82.90	1.56	125.81	0	121.27	0
Landing	75.70	0	75.70	0	75.70	0	75.70	0

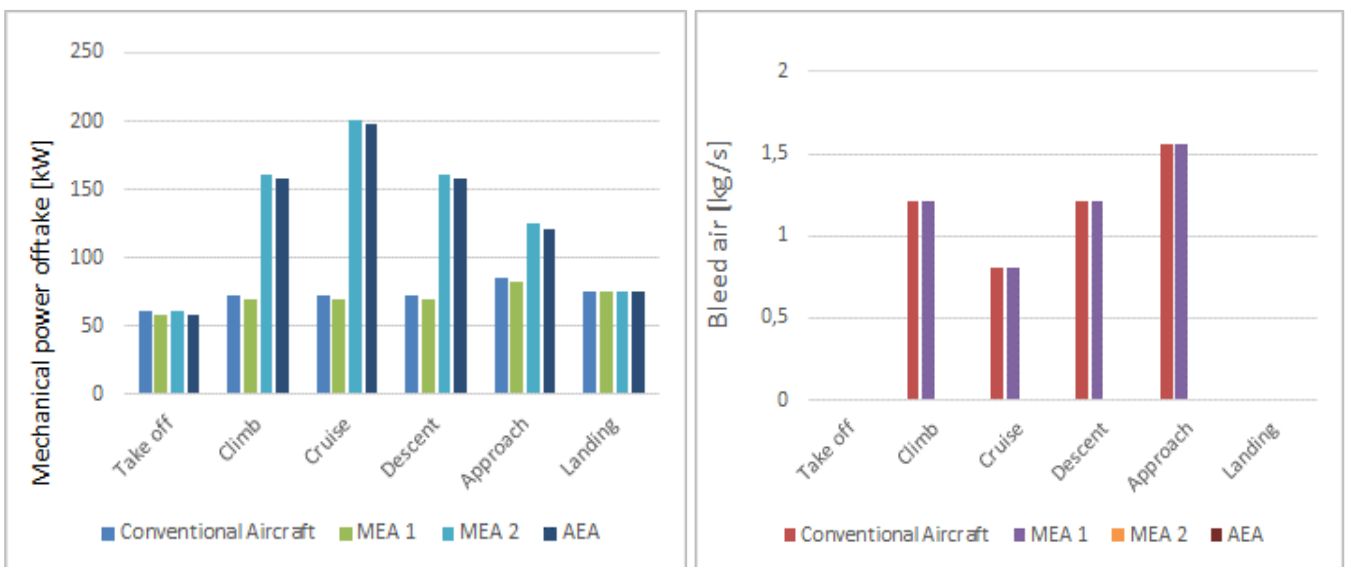

i) Mechanical power offtake

ii) Bleed air offtake

Figure 14. Total mechanical and bleed air offtakes required from the selected OBS architectures within the mission profile.

The different typology of power offtakes (i.e. mechanical and pneumatic) involves a different effect on engine efficiency. The influences of power offtakes on the engine cruise performance are presented in Figure 15 for the baseline engine (i.e. BPR = 12). In more detail, the influence of shaft power offtakes relative to installed cruise Specific Fuel Consumption SFCMCR is depicted on the left side of Figure 15. The influence of bleed air on SFCMCR is shown in right side of Figure 15.

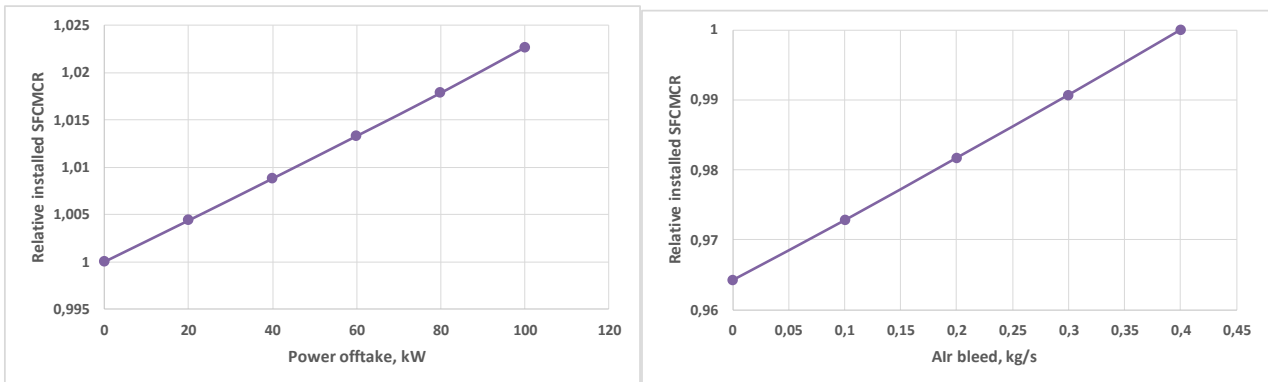

Figure 15. Relative installed cruise SFC vs. power offtake (left) and air bleed (right)

As is shown on the plot, if power offtakes increase from 0 kW to 100 kW, SFCMCR increases by 2.3%, which means that change of power offtakes by 1% leads to a change of SFCMCR by 0.023%. If bleed air decreases from 0.4 kg/s to 0 kg/s, SFCMCR improves by 3.6%. Therefore, a reduction of 1% in bleed air leads to a change of SFCMCR by 0.036%. In general, the impact of bleed air compared to shaft power on SFCMCR is more than 1.5 times higher.

The effects of the different OBS architectures on OAD are mainly due to the different systems masses and the different amount of fuel required. The main aircraft masses are listed in Table 9 for each architecture. With the increase of electrification level, the saving in fuel mass increases from 0.83% to about 3%. The same trend is experienced by MTOM that decreases from 0.54% to 1.03%. The minimum of OEM is reached by MEA1 followed by AEA and MEA2. Despite this, the lower efficiency of the OBS technologies selected for MEA1 increases the FM in comparison to the other innovative solutions and it determines a slightly lower reduction in MTOM compared to AEA. A parameter, which is related to the electrification level, is the power required by the electric system. It is listed in the last row of Table 9 as relative value compared to the electric system power of the Conv OBS architecture. It is worth noting that the increment of the electrification level is notable especially for MEA2 and AEA configurations. Figure 16 shows the trend of main aircraft masses with the increase of the electrification level. The FM trend is well defined and it shows the relation between the systems efficiency with their electrification. The MTOM and especially the OEM indicate that the mass reduction depends on the specific OBS architecture and it could be not directly connected with the electrification level. Moreover, these results are related to the reference regional aircraft. Different results can be expected for aircraft class with longer mission range where the OBS efficiency produces greater advantages in terms of MTOM reduction [33].

Table 9. Effects of OBS electrification on OAD in absolute terms and in relative terms compared to the baseline (Conv).

Aircraft main specifications	Conv	MEA1	MEA2	AEA
Payload Mass [kg]	11500	11500	11500	11500
Fuel Mass [kg]	7867	7802	7663	7632
variation compared to baseline [%]	-	-0.83	-2.59	-2.99
Operating Empty Mass [kg]	23965	23600	23933	23756
variation compared to baseline [%]	-	-1.52	-0.13	-0.87
Maximum Take-Off Mass [kg]	43332	42902	43096	42888
variation compared to baseline [%]	-	-0.99	-0.54	-1.03
Design variables				
Engine BPR	12	12	12	12
OBS architecture	Conv	MEA1	MEA2	AEA
Electrification level compared to baseline [%]	-	38	245	283

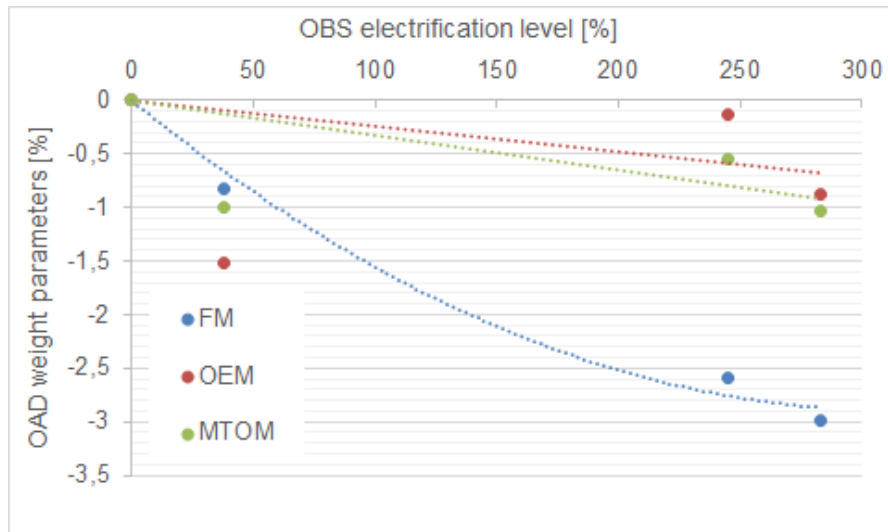

Figure 16. Main OAD masses trend with OBS electrification level.

With regard to the cost estimation and moving to more detailed analysis on the four different system architectures of the BPR12 engine, Figure 17 shows the change in RC in percentages with the conventional architecture (BPR12_conv) as a baseline.

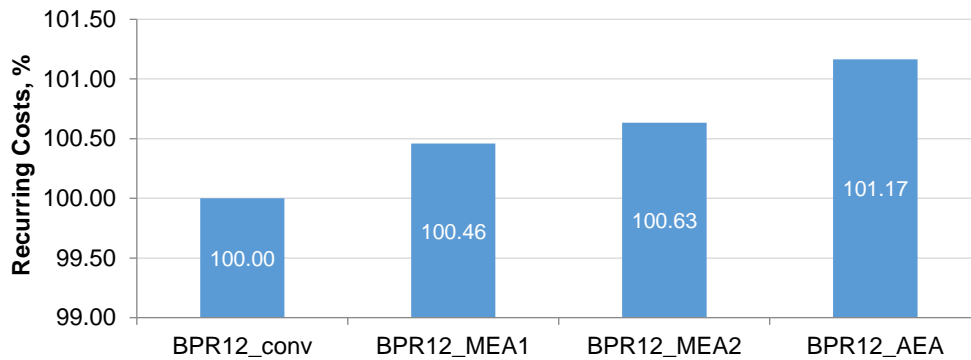

Figure 17. RC for different system architectures (BPR12 engine)

It can be seen, that the total change of RC is around 1% for all architectures, which corresponds to approx. \$ 260000 in terms of absolute numbers. There are various reasons behind these observed changes. MEA1 architecture for instance has no hydraulic system and therefore a relatively complex electrically driven FCS with a higher price of the equipment than a conventional one. The AEA architecture is the most expensive one, because of the greater cost of its equipment. This is due to the associated cost necessary to develop this new and more electrified equipment.

A closer examination of the COC results (see Figure 18 ii) for the BPR12 studies shows that the above-described effect of higher RC for a larger amount of electrification is eliminated by the increased operational efficiency. The higher RC can be overcompensated by the decrease in COC after one year of operations when moving from the conventional to each of the more/all electric system architectures.

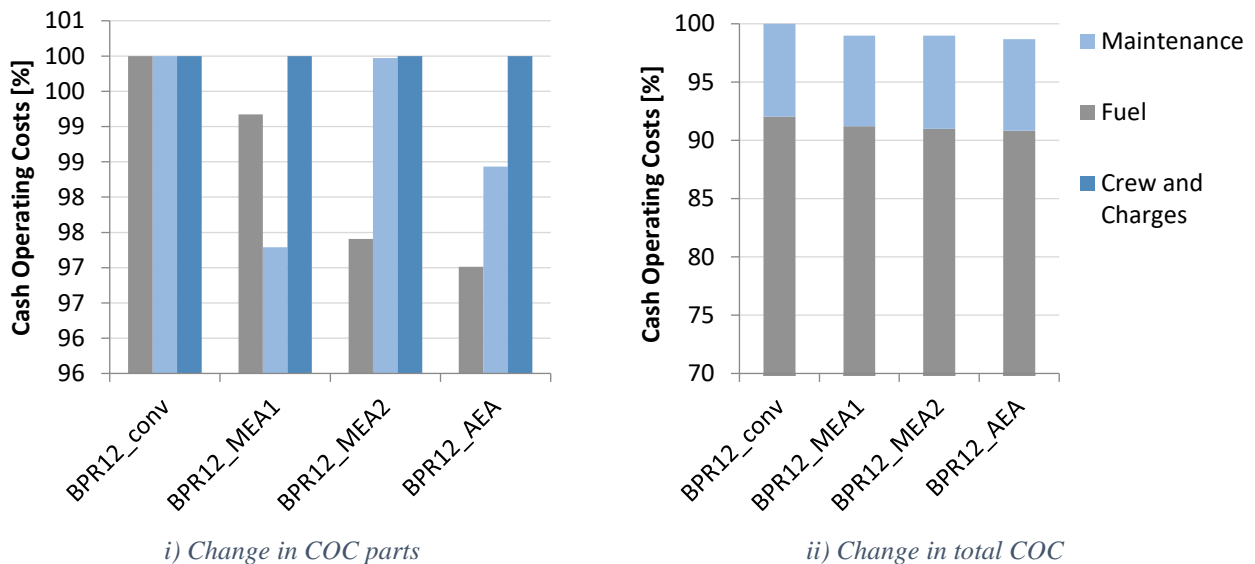

Figure 18. COC results for different on-board system architectures (BPR12 engine)

The AEA architecture results in the lowest total COC of all on-board system architectures. This is directly proportional to the amount of fuel mass consumed during the mission, as it can be seen from Figure 18. Please note that costs for crew and charges (navigation, landing, ground handling) are constant, whereas maintenance and fuel costs vary for the different system architectures (see

Figure 18 i). This shows that the amount of electrification also has an impact on maintenance expenses in the performed study. The MEA1 architecture leads to the lowest maintenance costs, whereas the MEA2 architecture has almost the same value as the conventional architecture. The reason for this is twofold. On the one hand, on the MEA1 the maintenance-expensive hydraulic system is removed, while the conventional ECS is retained. The AEA concept has a more complex architecture with an electric ECS. On the other hand, the hydraulic system of MEA2 is retained, while at the same time the electrification of the ECS leads to an increase in maintenance expenses of the electric system. Therefore, MEA1 architecture appears the most favorable architecture in terms of maintenance. Please note that the above described cost effects result from the underlying cost models of the RWTH Aachen tools [44] [45] and they may vary when applying a different methodology.

5. CONCLUSION

Within the AGILE H2020 research project, different multidisciplinary design workflows are set up. Conceptual and preliminary aircraft design MDAO workflows are developed. The present work is focused on the preliminary design workflow and its execution to quantify the effects of some design variables on the overall aircraft, engine performance and recurring and operating costs. The workflow belongs to the third generation MDAO, more devoted to the integration of expertise than integration of tools, keeping each involved expert aware of the results and the effect of his discipline on the others.

To enable the experts' awareness of the disciplinary and global design results, a set of main design variables are analysed. The engine BPR and the OBS level of electrification are selected to investigate the influence on the aircraft design, providing results which are in line with state-of-the-art insights. Some important outcomes are presented in terms of effect of OBS technologies on the engine performance and effect of engine BPR on the main masses and costs of a regional reference aircraft. In particular, the variation of the engine BPR shows quantitatively the importance of the engine mass and drag compared to the fuel saved when high BPR is considered. Moreover, analysing the BPR in terms of cost, the slight COC saving produced by high BPR is dampened by far greater increase of RC, showing the best compromise may be obtained for BPR = 12. In the same way, the OBS level of electrification is investigated, showing discontinuous results. These discontinuous results are mainly due to the short mission range typical of the regional aircraft segment. For this reference aircraft, the effect of OBS electrification on MTOM is mainly due to the variation of OEM instead of FM, fostering MEA1 and AEA architectures. This is an interesting result considering the opposite level of electrification of MEA1 and AEA. The level of electrification is a parameter more connected to the OBS efficiency, hence fuel consumption, and it may entail more advantages for long haul aircraft. In terms of cost, the same discontinuing results are observed especially for COC, whereas a linear dependency is shown for RC. Therefore, both MEA1 and AEA reach optimal results for regional aircraft.

The set up MDAO workflow contributes to the assessment of the correct integration of the different disciplinary design modules involved. This is one of the main aim of the AGILE research program. However, some limitations of the current research study need further improvements. Firstly, more experiments can be conducted to increase the depth of the investigation on the selected variables. This would enhance the confidence on the design results. Moreover, optimization problems may be formulated to determine the best combination of disciplinary variables. Nevertheless, additional

disciplinary analyses (e.g. reliability, safety and maintainability) should be included within the MDO process, with aim of completely investigated all the mutual influences among disciplines. Finally, a more accurate analysis of the effect of the interaction between the design disciplines should be carried out. In particular, the effect of their interaction on the main OAD parameters should be investigated. In this way, the real potentiality of MDAO workflows can be exploited understanding more accurately the connection between each main design parameters.

ACKNOWLEDGMENT

The research presented in this paper has been performed in the framework of the AGILE project (Aircraft 3rd Generation MDO for Innovative Collaboration of Heterogeneous Teams of Experts) and has received funding from the European Union Horizon 2020 Programme (H2020-MG-2014-2015) under grant agreement no 636202.

The Ministry of Education and Science of the Russian Federation financially supports the Russian part. All mentioned in this article TsAGI studies were carried out in the framework agreement no 14.628.21.0004 (Project unique identifier RFMEFI62815X0004).

The authors are grateful to the partners of the AGILE consortium for their contribution and feedback.

REFERENCES

- [1] D. Raymer, Enhancing aircraft conceptual design using multidisciplinary optimization, Doctoral Thesis.
- [2] J. Sobieszczanski-Sobieski, "Multidisciplinary Design Optimization: An Emerging New Engineering Discipline," *Advances in Structural Optimization*, pp. 483-496, 1995.
- [3] C. Werner-Westphal, W. Heinze and P. Horst, "Multidisciplinary Integrated Preliminary Design Applied to Unconventional Aircraft Configuration," *Journal of Aircraft*, vol. 45, no. 2, pp. 581-590, 2008.
- [4] J. R. R. A. Martins and A. B. Lambe, "Multidisciplinary Design Optimization: A Survey of Architectures," *AIAA Journal*, Vol. 51, No. 9, pp. 2049-2075, 2013.
- [5] E. Baalbergen, J. Kos, C. Louriou, C. Campguilhem and J. Barron, "Streamlining cross-organisation product design in aeronautics," *Proc IMechE Part G: J Aerospace Engineering*, vol. 231, no. 12, pp. 2192-2202, 2017.
- [6] P. D. Ciampa and B. Nagel, "Towards the 3rd generation MDO collaborative environment," in *ICAS*, 2016.
- [7] L. Boggero, M. Fioriti and S. Corpino, "Conceptual design methodology for a parallel hybrid aircraft with propelled engine," *Proc IMechE Part G: J Aerospace Engineering*, 2017.
- [8] L. Boggero, M. Fioriti, C. S. Ragusa and S. Corpino, "Trade off studies of hybrid-electric aircraft by Fuzzy Logic methodology," *International Journal of Applied Electromagnetics and Mechanics*, vol. 56, pp. 143-152, 2018.

- [9] T. Zill, P. D. Ciampa and B. Nagel, "Multidisciplinary design optimization in a collaborative distributed aircraft design system," in *50th AIAA Aerospace Sciences Meeting*, Nashville (TN), 2012.
- [10] R. Belie, "Non-Technical Barriers to Multidisciplinary Optimization in the Aerospace Industry," in *9th AIAA/ISSMO Symposium on Multidisciplinary Analysis and Optimization*, Atlanta (GA), 2002.
- [11] T. U. Braunschweig, "Preliminary Aircraft Design and Optimization Program," [Online]. Available: <https://www.tu-braunschweig.de/ifl/simulationswerkzeuge/prado>. [Accessed May 2019].
- [12] A. Alzubbi, A. Ndiaye, B. Mahdavi, F. Guibault, B. Ozell and J.-Y. Trepanier, "On the use of JAVA and RMI in the development of a computer framework for MDO," in *8th AIAA Symposium on Multidisciplinary Analysis and Optimization*, Long Beach (CA), 2000.
- [13] "openMDAO," NASA Glenn Research Center, [Online]. Available: <http://openmdao.org/>.
- [14] "The DAKOTA Project," Sandia National Laboratories, [Online]. Available: <http://dakota.sandia.gov>.
- [15] E. Kessler and M. Guenov, *Advances in Collaborative Civil Aeronautical Multidisciplinary Design Optimization*, American Institute of Aeronautics and Astronautics, 2010.
- [16] E. Baalbergen, A. Kanakis and W. Vankan, "A practical approach for coordination of multi-partner engineering jobs in the design of small aircraft," *CESAR Special Issue of Journal Czech Aerospace Proceedings*, vol. 3, 2009.
- [17] P. Coleman, "Innovations in collaborative modelling and simulation to deliver the Behavioural Digital Aircraft. CRESCENDO Forum Participants Handbook," Toulouse, 2012.
- [18] T. Consortium, "EU FP7 TOICA Project public web page," [Online]. Available: <http://www.toica-fp7.eu/>.
- [19] "AGILE "Aircraft 3rd Generation MDO for Innovative Collaboration of Heterogeneous Teams of Experts"," [Online]. Available: <http://www.agile-project.eu/>.
- [20] "Official RCE Webpage," DLR, Air Transportation Systems, [Online]. Available: <http://rcenvironment.de/>. [Accessed March 2018].
- [21] "Noesis Optimus software," [Online]. Available: <https://www.noesisolutions.com/our-products/optimus>. [Accessed March 2018].
- [22] I. van Gent, P. D. Ciampa, B. Aigner, J. Jepsen, G. La Rocca and J. Schut, "Knowledge architecture supporting collaborative MDO in the AGILE paradigm," in *18th AIAA/ISSMO Multidisciplinary Analysis and Optimization Conference*, Denver (CO), 2017.
- [23] P. D. Ciampa and B. Nagel, "The AGILE Paradigm: the next generation of collaborative MDO," in *18th AIAA/ISSMO Multidisciplinary Analysis and Optimization Conference*, Denver (CO), 2017.
- [24] P. D. Ciampa, E. Moerland, D. Seider, E. Baalbergen, R. Lombardi and R. D'Ippolito, "A Collaborative Architecture supporting AGILE Design of Complex Aeronautics Products," in *18th AIAA/ISSMO Multidisciplinary Analysis and Optimization Conference*, Denver (CO), 2017.
- [25] P. S. Prakasha, L. Boggero, M. Fioriti, B. Aigner, P. D. Ciampa, K. Anisimov, A. Savelyev, A. Mirzoyan and A. Isianov, "Collaborative System of Systems Multidisciplinary Design Optimization for Civil Aircraft:AGILE EU project," in *18th AIAA/ISSMO Multidisciplinary Analysis and Optimization Conference*, Denver, Colorado (USA), 2017.

- [26] P. S. Prakasha, P. D. Ciampa, L. Boggero and M. Fioriti, "Assessment of airframe-subsystems synergy on overall aircraft performance in a Collaborative Design," in *17th AIAA/ISSMO Multidisciplinary Analysis and Optimization Conference*, Washington D.C. (USA), 2016.
- [27] P. S. Prakasha, P. Della Vecchia, P. D. Ciampa, D. Ciliberti, D. Charbonnier, A. Jungo, M. Fioriti, L. Boggero, A. Mirzoyan, K. Anisimov, M. Zhang and M. Voskuij, "Model based collaborative design & optimization of blended wing body aircraft configuration: AGILE EU project," in *18th AIAA Aviation Technology, Integration, and Operations Conference*, Atlanta, 2018.
- [28] "VAMPzero - Conceptual Design for the Needs of MDO," [Online]. Available: <https://software.dlr.de/p/vampzero/home/>. [Accessed 1 May 2018].
- [29] J. Kurzke, "Gas turbine cycle design methodology: a comparison of parameter variation with numerical optimization," *Journal of engineering for gas turbines and power*, vol. 121, no. 1, pp. 6-11, 1999.
- [30] M. Fioriti, L. Boggero, S. Corpino, A. Isyanov, A. Mirzoyan, R. Lombardi and R. D'Ippolito, "Automated Selection of the Optimal On-board Systems Architecture," in *18th AIAA/ISSMO Multidisciplinary Analysis and Optimization Conference*, Denver (CO), 2017.
- [31] L. Boggero, M. Fioriti, S. Corpino and P. D. Ciampa, "On-Board Systems Preliminary Sizing in an Overall Aircraft Design Environment," in *17th AIAA Aviation Technology, Integration, and Operations Conference, AIAA AVIATION Forum*, Denver (CO), 2017.
- [32] M. J. Cronin, "All-Electric vs Conventional Aircraft: The Production/Operational Aspects," *AIAA Journal of Aircraft*, vol. 20, no. 6, pp. 481-486, 1983.
- [33] M. Sinnet, "787 No-Bleed Systems: Saving Fuel and Enhancing Operational Efficiencies," *Aero Quarterly QTR_04 | 07*, pp. 06-11, 2007.
- [34] I. Chakraborty and D. N. Mavris, "Integrated Assessment of Aircraft and Novel Subsystem Architectures in Early Design," in *54th AIAA SciTech*, San Diego (CA), 2016.
- [35] S. Chiesa, S. Farfaglia, M. Fioriti and N. Viola, "Design of all electric secondary power system for future advanced medium altitude long endurance unmanned aerial vehicles," *Proceedings of the Institution of Mechanical Engineers, Part G: Journal of Aerospace Engineering*, vol. 226, no. 10, pp. 1255-1270, 2012.
- [36] S. Chiesa, S. Corpino, M. Fioriti, A. Rougier and N. Viola, "Zonal safety analysis in aircraft conceptual design: Application to SAvE aircraft," *Proceedings of the Institution of Mechanical Engineers, Part G: Journal of Aerospace Engineering*, vol. 227, no. 4, pp. 714-733, 2013.
- [37] P. Giannakakis, P. Laskaridis and P. Pilidis, "Effects of Offtakes for Aircraft Secondary-Power Systems on Jet Engine Efficiency," *Journal of Propulsion and Power*, vol. 27, no. 5, pp. 1024-1031, 2011.
- [38] M. Fioriti, L. Boggero, S. Corpino, P. S. Prakasha, P. D. Ciampa and B. Nagel, "The Effect of Sub-systems Design Parameters on Preliminary Aircraft Design in a Multidisciplinary Design Environment," *Transportation Research Procedia*, vol. 29, pp. 135-145, 2018.
- [39] T. Lefebvre, N. Bartoli, S. Dubreuil, M. Panzeri, R. Lombardi, R. D'Ippolito, P. Della Vecchia, F. Nicolosi, P. D. Ciampa, K. Anisimov and A. Savelyev, "Methodological enhancements in MDO process investigated in the AGILE European project," in *18th AIAA/ISSMO Multidisciplinary Analysis and Optimization Conference*, Denver, 2017.
- [40] K. S. Anisimov and A. A. Savelyev, "Aerodynamic Optimization of Airplane Propulsion System within the Framework of AGILE Project," in *30th ICAS Congress*, Daejeon, Korea, 2016.

- [41] A. Savelyev, K. Anisimov, E. Kazhan, I. Kursakov and A. Lysenkov, "Computational Study of Engine External Aerodynamics as a Part of Multidisciplinary Optimization Procedure," *AIP Conference Proceedings*, vol. 1770, no. 1, 2016.
- [42] "Aircraft Design & Design Methodologies - Aircraft Design Initiator," TU-Delft, [Online]. Available: <https://www.tudelft.nl/en/ae/organisation/departments/aerodynamics-wind-energy-flight-performance-and-propulsion/flight-performance-and-propulsion/flight-performance/research/aircraft-design-design-methodologies/>. [Accessed March 2018].
- [43] S. Chiesa and M. Fioriti, "UAV logistic support definition," in *Handbook of Unmanned Aerial Vehicles*, Springer Netherlands, 2015, pp. 2565-2600.
- [44] T. Lammering, K. Franz, K. Risse, R. Hoernschemeyer and E. Stumpf, "Aircraft Cost Model for Preliminary Design Synthesis," in *50th AIAA Aerospace Sciences Meeting*, Nashville, TN, 2012.
- [45] K. Franz, T. Lammering, K. Risse, E. Anton and R. Hoernschemeyer, "Economics of Laminar Aircraft Considering Off-Design Performance," in *53rd AIAA/ASME/ASCE/AHS/ASC Structures, Structural Dynamics and Materials Conference*, Honolulu, HI, 2012.