

A dry friction model and robust computational algorithm for reversible or irreversible motion transmissions

Original

A dry friction model and robust computational algorithm for reversible or irreversible motion transmissions / Borello, L.; Dalla Vedova, M. D. L.. - In: INTERNATIONAL JOURNAL OF MECHANICS AND CONTROL. - ISSN 1590-8844. - 13:2(2012), pp. 37-48.

Availability:

This version is available at: 11583/2850065 since: 2020-10-27T08:39:05Z

Publisher:

Levrotto&Bella

Published

DOI:

Terms of use:

This article is made available under terms and conditions as specified in the corresponding bibliographic description in the repository

Publisher copyright

(Article begins on next page)

International Journal of Mechanics and Control

Editor: Andrea Manuello Bertetto

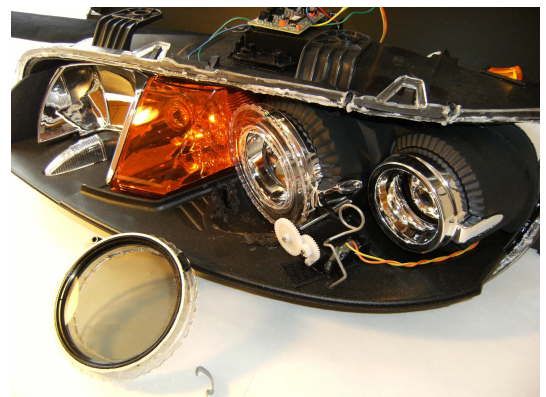
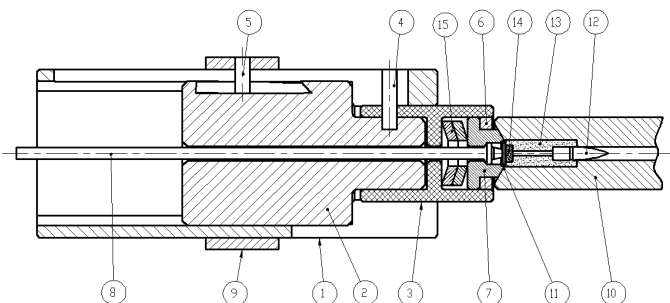
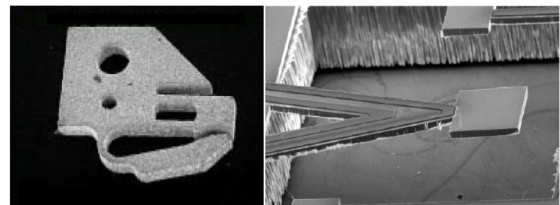
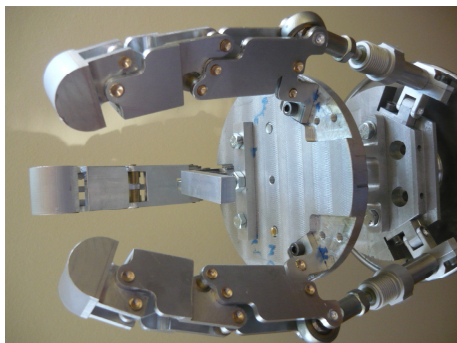
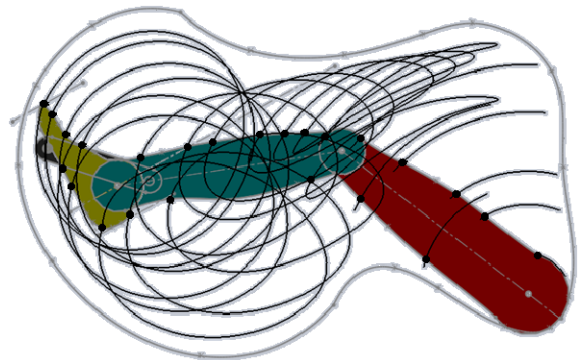

Editorial Board of the
International Journal of Mechanics and Control

Published by Levrotto&Bella – Torino – Italy E.C.

Honorary editors

Guido Belforte

Kazy Yamafuji

Editor: Andrea Manuello Bertetto

General Secretariat: Elvio Bonisoli

Atlas Akhmetzyanov
*V.A.Trapeznikov Institute of Control Sciences
of Russian Academy of Sciences
Moscow – Russia*

Domenico Appendino
*Prima Industrie
Torino – Italy*

Kenji Araki
*Saitama University
Shimo Okubo, Urawa
Saitama – Japan*

Guido Belforte
*Technical University – Politecnico di Torino
Torino – Italy*

Bruno A. Boley
*Columbia University,
New York – USA*

Marco Ceccarelli
*LARM at DIMSAT
University of Cassino
Cassino – Italy*

Amalia Ercoli Finzi
*Technical University – Politecnico di Milano
Milano – Italy*

Carlo Ferraresi
*Technical University – Politecnico di Torino
Torino – Italy*

Anindya Ghoshal
*Arizona State University
Tempe – Arizona – USA*

Nunziatino Gualtieri
*Space System Group
Alenia Spazio
Torino – Italy*

Alexandre Ivanov
*Technical University – Politecnico di Torino
Torino – Italy*

Giovanni Jacazio
*Technical University – Politecnico di Torino
Torino – Italy*

Takashi Kawamura
*Shinshu University
Nagano – Japan*

Kin Huat Low
*School of Mechanical and Aerospace Engineering
Nanyang Technological University
Singapore*

Andrea Manuello Bertetto
*University of Cagliari
Cagliari – Italy*

Stamos Papastergiou
*Jet Joint Undertaking
Abingdon – United Kingdom*

Mihailo Ristic
*Imperial College
London – United Kingdom*

János Somló
*Technical University of Budapest
Budapest – Hungary*

Jozef Suchy
*Faculty of Natural Science
Banska Bystrica – Slovakia*

Federico Thomas
*Instituto de Robótica e Informática Industrial
(CSIC-UPC)
Barcelona – Espana*

Lubomir Uher
*Institute of Control Theory and Robotics
Bratislava – Slovakia*

Furio Vatta
*Technical University – Politecnico di Torino
Torino – Italy*

Vladimir Viktorov
*Technical University – Politecnico di Torino
Torino – Italy*

Kazy Yamafuji
*University of Electro-Communications
Tokyo – Japan*

*Official Torino Italy Court Registration
n.5390, 5th May 2000*

*Deposito presso il Tribunale di Torino
numero 5390 del 5 maggio 2000*

Direttore responsabile:

Andrea Manuello Bertetto

International Journal of Mechanics and Control

Editor: Andrea Manuello Bertetto

***Honorary editors: Guido Belforte
Kazy Yamafuji***

General Secretariat: Elvio Bonisoli

The Journal is addressed to scientists and engineers who work in the fields of mechanics (mechanics, machines, systems, control, structures). It is edited in Turin (Northern Italy) by Levrotto&Bella Co., with an international board of editors. It will have not advertising.

Turin has a great and long tradition in mechanics and automation of mechanical systems. The journal would will to satisfy the needs of young research workers of having their work published on a qualified paper in a short time, and of the public need to read the results of researches as fast as possible.

Interested parties will be University Departments, Private or Public Research Centres, Innovative Industries.

Aims and scope

The *International Journal of Mechanics and Control* publishes as rapidly as possible manuscripts of high standards. It aims at providing a fast means of exchange of ideas among workers in Mechanics, at offering an effective method of bringing new results quickly to the public and at establishing an informal vehicle for the discussion of ideas that may still in the formative stages.

Language: English

International Journal of Mechanics and Control will publish both scientific and applied contributions. The scope of the journal includes theoretical and computational methods, their applications and experimental procedures used to validate the theoretical foundations. The research reported in the journal will address the issues of new formulations, solution, algorithms, computational efficiency, analytical and computational kinematics synthesis, system dynamics, structures, flexibility effects, control, optimisation, real-time simulation, reliability and durability. Fields such as vehicle dynamics, aerospace technology, robotics and mechatronics, machine dynamics, crashworthiness, biomechanics, computer graphics, or system identification are also covered by the journal.

Please address contributions to

Prof. Guido Belforte
Prof. Andrea Manuello Bertetto
PhD Eng. Elvio Bonisoli

*Dept. of Mechanics
Technical University - Politecnico di Torino
C.so Duca degli Abruzzi, 24.
10129 - Torino - Italy - E.C.*

www.jomac.it
e_mail: jomac@polito.it

Subscription information

Subscription order must be sent to the publisher:

*Libreria Editrice Universitaria
Levrotto&Bella
2/E via Pigafetta – 10129 Torino – Italy*

www.levrotto-bella.net
e_mail: info@levrotto-bella.net
tel. +39.011.5097367
+39.011.5083690
fax +39.011.504025

A DRY FRICTION MODEL AND ROBUST COMPUTATIONAL ALGORITHM FOR REVERSIBLE OR IRREVERSIBLE MOTION TRANSMISSIONS

Lorenzo Borello Matteo D. L. Dalla Vedova

Department of Mechanical and Aerospace Engineering - Politecnico di Torino
Corso Duca degli Abruzzi 24 – 10129 Torino, Italy

ABSTRACT

The motion transmission elements are generally affected by dry friction which may give rise to reversible or irreversible behaviour of the whole system. So, the potential high effect of the dry friction on the dynamic behaviour of the mechanical system requires proper simulation models characterised by high computational accuracy, nevertheless compactness and efficiency. Aims of the work are:

- the proposal of a general purpose physical and mathematical dry friction dynamic model and, consequently, the detailed description of two related numerical algorithms, developed in different computational environments (low level language and Matlab-Simulink), able to simulate the behaviour of a general dynamic system affected by dry friction and equipped or not with ends of travel;
- the simulation of some representative actuation runs in order to validate the proper accuracy of the mechanical device computational algorithm and the analysis of the results.

Keywords: coulomb, friction, actuator

1 INTRODUCTION

A typical mechanical problem regards the actuation systems in which one or more motor elements drive one or more mechanical users via a motion transmission; in some cases, the actuation system is a part of a servomechanism, expiring the control of position of the user. The simulation of the dynamic behaviour of these systems may require mathematical models having the ability to take into account the usually undesired effects of dry friction forces/torque, more or less affecting all the working conditions. If the system is equipped with mechanical ends of travel, their effect must be properly taken into account by the model

itself, without any prejudice of the correct dry friction simulation. Generally, whichever the motor or user types are, the motion transmission consists of a certain number of shafts, gears, screws, ballscrews, epicyclical gears and so on, neglecting driving belts and pulleys.

The motion transmission elements are generally affected by dry friction which may give rise to reversible or irreversible behaviour of the whole system. So, the potential high effect of the dry friction on the dynamic behaviour of the mechanical system requires proper simulation models characterised by high computational accuracy, nevertheless compactness and efficiency.

2 AIMS OF THE WORK

Aims of the work are:

- the study, development, validation and proposal of a general purpose physical and mathematical dry friction dynamic model and, especially, of related simulation computational algorithm.

Contact author: Matteo D. L. Dalla Vedova ¹

¹Department of Mechanical and Aerospace Engineering
Politecnico di Torino
Corso Duca degli Abruzzi 24 – 10129 Torino, Italy.
E-mail: matteo.dallavedova@polito.it

- The problem concerns any type of mechanical device having moving parts, as motion transmissions and gears, affected by dry friction and equipped or not with ends of travel (the authors' specific interest regards the aircraft flight control system actuators); in particular, a new dynamic model/algorithm is proposed in which dry friction is considered to be the sum of both a portion proportional to the load acting on the driven element (through a proper value of efficiency) and a portion independent on it, however being dependent on the relative velocity;
- the detailed description of a general purpose low level language (Fortran, C) numerical algorithm, able to perform the simulations of the dynamic behaviour of the mechanical device being thought in the form of typical flap control system equipped with motion actuators;
- the implementation of a Matlab-Simulink numerical algorithm, having the same purpose as above;
- the simulation of some representative actuation runs in order to validate the proper accuracy of the mechanical device computational algorithm and the analysis of the results.

3 PHYSICAL - MATHEMATICAL MODEL

The dry friction affecting the relative movement of the components of a mechanical system, as, for example, a motion transmission, consists of a force/torque opposing the motion itself, having a value variable as a function of the relative velocity.

In the most of the applications however the relationship between friction force and speed can be represented by the following model (classical Coulomb friction):

- in standstill conditions the friction force can assume any value lower or equal in module to the so said static friction value, opposing the active force and depending on it;
- otherwise the force module has a constant value equal to the so said dynamic friction value, opposing the motion.

This highly nonlinear relationship (discontinuous and undefined in null velocity conditions) gives rise to difficulty in numerical simulation of friction phenomena for the abovementioned purposes. Several different theories have been developed about this problem and the related works fall essentially in two categories concerning the two aspects of the problem itself: continuous and discontinuous types. The aim of the former is mainly the conception of a physical-mathematical model able to represent more and more accurately the relationship between the friction force/torque and the relative velocity of the mechanical parts. Some continuous models consider small elastic displacement (presliding displacement) in the sticking regime and are particularly interesting in the study of specific problems around the null velocity condition (elasto-plastic models [6] et al. [5]), having no further abilities in slipping conditions.

A different problem is considered by the latter category: these models mainly regard the study of mathematical and logical algorithms conceived for the dynamic simulation of mechanical systems characterised by large movements, by integrating, step by step, the equilibrium equations of the moving parts in time dominion: particularly, the algorithms must be able to correctly compute the motion, standstill, stopping, breakaway and reversion conditions.

Typically, in these models the friction force is discontinuous at zero velocity (i.e., in sticking regime) and acts to balance the other forces to maintain zero velocity, if possible. Advantages of discontinuous models are their high performance to simplicity ratio and their wide application field in the classical applied mechanics. However, the conception of the related numerical algorithms is not so simple because their two formulations in conditions of zero and nonzero velocity are completely different; some of the discontinuous friction models most often used are the basic Coulomb (usually implemented by means of a SIGN function), the hyperviscous, the Quinn [4] and Karnopp [3] models, which provide alternative tradeoffs amongst the desirable characteristics of a friction model.

In general, the two categories of problems can be merged together: that is, different friction vs. velocity relationships (nevertheless the Coulomb model) can be suited to simulate every type of motion, standstill, stopping and breakaway algorithm. However, in the most of the applications, considering the friction force/torque vs. velocity relationship, the Coulomb friction approximation is generally satisfactory when the purpose is the dynamic simulation of the behaviour of a multi-component mechanical system characterised by large movements, such as, especially, a motion transmission is, leading a user mechanism and driven by a motor, eventually as a part of a position servo-controller (servomechanism); the load acting on the user mechanism or controlled component may have the same (aiding load) or the opposite (opposing load) sense with respect to the actual motion or, in standstill conditions, to the eventually incipient motion.

In the authors' opinion, the accuracy of the time dynamic simulation of the behaviour of a mechanical system, or position servocontroller, is mainly (nay, much more) dependent on the reliable, robust and trouble-free conception of the algorithm intended to compute motion, standstill, stopping and breakaway conditions; smaller importance is ascribed to the type of friction vs. velocity relationship implemented within the computational algorithm.

Therefore, in the present work, the authors' attention will be much more focused on the former than on the latter considerations. According to these reasons the authors' model employs the Coulomb friction approximation; the consequent relationship among force/torque and velocity (standstill or motion conditions) has been afore described and detailed.

The mathematical and logical algorithm employable to the purpose must be able to perform the behaviour of a movable element affected by friction forces/torques, distinguishing the working condition between the eventual persistence in motion or at a standstill, or the possible motion reversion, breakaway or stopping.

This ability can be important in order to point out some undesired behaviours characterising mechanical devices and particularly servomechanisms.

Like previously said (Coulomb approximation), the evaluation of the dry friction, as a function of the velocity, cannot be described at all by linear models (even though more favourable for the possible analytical solutions of the related dynamic equations). Therefore, whichever attempt of suitable and realistic mathematical modelling requests the use of so complex nonlinearities to advise the employment of numerical computing techniques based on the dynamic simulation in time dominion.

However the techniques of numerical solution mainly employed (and generally reported in nonspecific literature) are based on mathematical models and corresponding computational algorithms that are affected by some shortcomings¹.

The proposed model overcomes the above-mentioned shortages and correctly simulates the behaviour of the mechanical device, as follows:

- selects the correct friction force/torque sign as a function of the relative velocity sense;
- computes the friction force/torque according to the actual external load value acting on the mechanical element;
- distinguishes between aiding and opposing load conditions;
- selects either the static (sticking) condition or the dynamic one (slipping);
- evaluates the eventual stop or breakaway of the previously running or sticking mechanical element respectively;
- keeps correctly in a standstill or motion condition the previously sticking or running mechanical element respectively;
- is able to compute properly the dynamic behaviour of both reversible and irreversible motion transmissions (actuators), taking into account the effects of their eventual mechanical ends of travel.

The proposed model is applied, for demonstration and validation, to the dynamics of an aircraft flight control system and particularly of the actuator-surface assembly, considered as a rigid mechanical element characterised by a single degree of freedom.

¹ Difficulty in implementing the above mentioned friction model in numerical algorithm is rooted in the definition of friction vs. relative velocity v relationship around $v = 0$ and joined computational criteria; in fact, this function is discontinuous with respect to v (and potentially undefined in standstill condition) and the complete definition of the friction value when $v = 0$ is possible by means of the actual external load.

4 FRICTION TORQUE EVALUATION

The dry friction models and computational algorithms available in literature are usually characterized by extremely simplified structures and limited performance; their shortcomings, easily verifiable by means of proper numerical simulations, are particularly emphasized if “integrated” dynamical models are employed, that not only describe the performance of the actuator in Matlab-Simulink taking into account the friction torques but estimating also the possible presence of mechanical ends of travel and their eventual interactions. The algorithm developed by the authors in Matlab-Simulink environment supplies an concrete answer to such problems and, by means of a self-contained subsystem, can describe the effects produced by friction torques on the dynamic behaviour of a generic solid mechanical moving element; the authors’ computational routine can correctly describe many of typical coulomb friction’s effects as well as their interactions with the eventual mechanical ends of travel. The true capabilities of the proposed Coulomb friction computational algorithm are the result of the implementation of a relatively simple but reliable and accurate mathematical model in the versatile Matlab-Simulink environment, so obtaining a self-contained, general-purpose routine employable in a lot of different mechanical applications. In the proposed model, the friction torque is defined in slipping condition as T_{FR} , opposite and invariable with the velocity; T_{FR} is considered as the sum of a component (T_{FR0}) not depending on the load (T_{LD}) and a further one (T_{FRL}) related to the load through a defined value of efficiency. About T_{FRL} , in order to simulate both reversible and irreversible actuators, the proposed model introduces two suitable definitions of efficiency. Usually the efficiency is conventionally defined as the ratio between the output and the input power (dynamic conditions) of a mechanical device as follows:

$$\eta = \frac{T_{OUT} \cdot \omega_{OUT}}{T_{IN} \cdot \omega_{IN}} \quad (1)$$

In (1) it is considered as the input side of the mechanism that in which the torque and angular velocity have the same sense and it is regarded as the output side that in which the torque and angular velocity have the opposite sense.

When the load is opposing the motion, $T_{IN}=T_M$ (motor torque) and $T_{OUT}=T_{LD}$ (aerodynamic load acting on the surface); if the load aids the motion, $T_{OUT}=T_M$ and $T_{IN}=T_{LD}$. If the device is characterised by a constant gear ratio $\tau=\omega_{OUT}/\omega_{IN}$ (typically any mechanism in which the motion is transmitted by the relative movement between conjugate profiles), the efficiency can be intended as the ratio between the output ($\tau \cdot T_{OUT}$) and the input (T_{IN}) torque (related to the same shaft – e.g. the motor one), in any condition:

$$\eta = \frac{T_{OUT}}{T_{IN}} \cdot \frac{\omega_{OUT}}{\omega_{IN}} = \frac{T_{OUT}}{T_{IN}} \cdot \tau = \frac{(\tau \cdot T_{OUT})}{T_{IN}} \quad (2)$$

The efficiency of the mechanism depends on the load condition related to the motion (aiding or opposing). Therefore, if the Coulomb friction model is employed, whatever moving part of a mechanism is characterised, in slipping conditions, by the following two different types of efficiency, which can be intended as follows:

η_{opp} = out/in torque ratio, opposing load

η_{aid} = out/in torque ratio, aiding load

In the opposing conditions the output torque is essentially represented by the load acting on the driven element and the input one by the driving torque (motor or leading element); vice versa in the aiding conditions (in aiding conditions, the usually driven element is considered as the leading one, or input, and the usually driving element as the driven one, or output). By an adequate selection of the values of the above reported efficiencies, it is possible to simulate the behaviour of both reversible and irreversible transmissions. Generally, the efficiencies of the irreversible transmissions are lower than the reversible ones; particularly the aiding efficiency of the irreversible arrangement must be intended as negative.

First of all, the model employs the efficiency value to compute the load dependent friction torque: in fact, the model computes it as the above-mentioned sum of a component not depending on the load (T_{FR0}) and a further one related to the load through the efficiency (T_{FRL}) as:

$$T_{FR} = T_{FR0} + T_{FRL} = T_{FR0} + \left(\frac{1}{\eta_{opp}} - 1 \right) \cdot T_{LD} \quad (3)$$

in opposing conditions and

$$T_{FR} = T_{FR0} + T_{FRL} = T_{FR0} + (1 - \eta_{aid}) \cdot T_{LD} \quad (4)$$

in aiding conditions.

It must be noted that the amount of η_{opp} (defined EtO in the rest of the paper) must lie in the interval between 0 and 1 in order to allow the motor drives the system, while the value of η_{aid} (defined EtA in the rest of the paper) must be not greater than 1; if the mechanical system is reversible the amount of EtA must lie in the interval between 0 and 1, if it is irreversible EtA must be not greater than 0 and the negative value is an expression of the irreversibility degree of the mechanical system. In fact, in slipping and aiding conditions, if EtA=0, the load produces a friction force T_{FR} that is equal and opposing to the load itself ($T_{FR}=T_{LD}$) and their net effect is null, so requiring no action by the motor (neither driving nor breaking); if EtA=-0.5 (or EtA=-1), T_{LD} develops an opposing amount of $T_{FR}=1.5 \cdot T_{LD}$ (or $T_{FR}=2 \cdot T_{LD}$) and their net effect results in a force opposing the motion and amounting to $0.5 \cdot T_{LD}$ (or $1 \cdot T_{LD}$), so requiring a driving action of $0.5 \cdot T_{LD}$ (or $1 \cdot T_{LD}$) by the motor. All these conditions are properly simulated by the algorithm. The model is conceived to compute directly the friction torque T_{FR} in slipping conditions; in case of sticking conditions, the maximum value which can be assumed by friction force is obtained multiplying the slipping one by FSD (static to dynamic friction ratio equal or greater than 1).

When the sticking condition persists, the absolute actual amount of friction force – requested to balance the active force – is not greater than the above considered maximum value. It must be noted that five possible conditions can occur at each computational step:

- Mechanical element initially sticking which must persist in sticking condition, being the absolute value of the active forces (and consequently of friction force) not greater than $FSD \cdot T_{FR}$;
- Mechanical element initially sticking which must breakaway, so turning to slipping condition, being the absolute value of the active forces greater than $FSD \cdot T_{FR}$;
- Mechanical element initially slipping which must keep the slipping condition in the same velocity sense (either when the absolute value of the active forces/torques is greater than T_{FR} , or simply when the element velocity has no-sign reversion within the considered computational step under all the forces acting on it, with respect to its inertia);
- Mechanical element initially slipping which must stop, so turning to sticking condition (having the velocity a potential sign reversion within the computational step, as a consequence of inertia and applied forces);
- Mechanical element initially slipping which must keep the slipping condition, following a motion reversion within the computational step, having the active forces/torques a value greater than $FSD \cdot T_{FR}$ and the sense opposing the initial motion.

The proposed dynamic simulation algorithm is able to distinguish among the conditions a), b), c) and d), solving them within the single considered computational step; the condition e) is performed by means of two following computational steps: the present step is considered as case d) and the following one as case b). It must be noted that this procedure computes a marginally time delayed breakaway (on an average the time-delay amounts to half computing interval). All these abilities are performed in case of both opposing and aiding load with respect to the actual movement or the eventual break-away (incipient motion). It must be noted that, when the external load aids the breakaway, the friction force to be considered is obtained through EtA, while when the external load opposes the breakaway, the incipient motion is performed against a friction force amount depending on EtO; so the procedure, evaluating the eventual breakaway, constrains the T_{FR} amount within two different limits, ruled by EtO and EtA respectively besides by FSD (turning the slipping friction value into the sticking as previously said).

5 ACTUATION SYSTEM MODELLING

5.1 REFERENCE SERVOMECHANISM DESCRIPTION

In order to validate the numerical load depending friction model, its behaviour is studied as a part of a typical electrohydraulic position servomechanism, widely used both in primary and secondary aircraft flight controls; it consists of the following three subsystems:

- a controller subsystem containing a control electronics and a servo-amplifier, typically implementing a PID control law (the present work refers to a pure proportional control law whose behaviour, under friction effects, is much more explicative);
- an electrohydraulic two stage servovalve;
- a hydraulic motor, motion transmission and aerodynamic surface assembly (affected by Coulomb friction), having hard-stops and provided by position transducers closing the control loop.

The full description of the servomechanism employed in the present work and its mathematical model are reported in [1] and [2]. The aforesaid servomechanism belongs to the fly-by-wire paradigm: the pilot's command, depending upon proper transducers, is usually expressed in terms of an electric analog or digital reference signal; this signal is continuously compared via a feedback loop with the actual position of the control surface generating the instantaneous position error as input to the control law. So, the error is processed and transformed into an electric current operating the electrohydraulic servovalve. The servovalve drives an actuator that moves the control surface continuously pursuing, by a proper control law, the reduction of the error between pilot's commanded position and flight surface actual position. The servovalve is a high performance two-stage valve: the corresponding model represents the first stage having a second order dynamics and the second stage as a first order dynamics. The ends of travel of first and second stage are computed. The model of the second stage fluid dynamics takes into account the effects of differential pressure saturations, leakage and variable supply pressure.

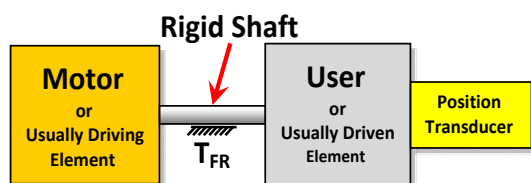

Figure 1 Single mass (1 dof) passive subsystem. Schematic of control system dynamic model.

The actuation system, as shown in Fig. 1, considered in the present paper is composed by a hydraulic motor driving an aerodynamic surface by means of a motion transmission: its model includes inertia, Coulomb and viscous friction and leakage effects through the piston seals developing a not working flow.

5.2 ANALYTICAL MODEL OF SERVOACTUATOR

The position error (Err), coming from the comparison of the instantaneous value of commanded position (Com) with the actual one (XJ), is processed by means of a PID law giving the suitable current input (Cor) acting on the servovalve first stage torque motor; the aforesaid engine torque (expressed as a function of Cor through the torque gain GM), reduced by the feedback effect due to the second stage position (XS), acts on the first stage second order

dynamic model giving the corresponding flapper position (XF) (limited by double translational hard stops).

The above mentioned flapper position causes a consequent spool velocity and, time-integrating, the displacement XS (limited by double translational hard stops $\pm XSM$).

The differential pressure P12 effectively acting on the hydraulic motor, by means of a pressure gain taking into account the saturation effects, is a function of XS and of the total flow through the valve itself.

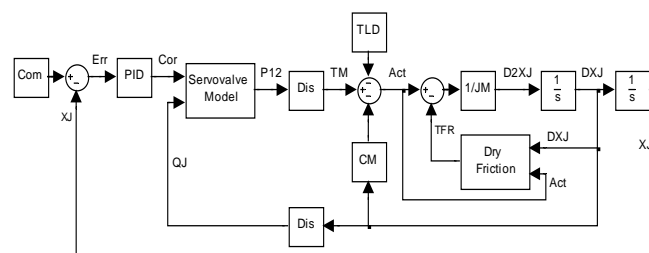

Figure 2 Theoretical actuator dynamics block diagram schematic.

As shown in Fig. 2, the differential pressure P12, through the motor displacement (Dis) and the equivalent total inertia of the surface-motor assembly (JM), taking into account the total load (T_{LD}), the viscous (coefficient CM) and dry friction torque (T_{FR}), gives the assembly acceleration (D2XJ). The equation representing the above mentioned dynamic equilibrium is

$$Act - T_{FR} = J_s \cdot D2XJ \quad (5)$$

where

$$Act = T_M - T_{LD} - C_M \cdot DXJ \quad (6)$$

represents the sum of the active forces/torques, which must be previously known (computed) to evaluate the friction.

The D2XJ time integration gives the velocity (DXJ), affecting the viscous and dry frictions and the linear actuator working flow QJ that, summed to the leakage one, gives the above mentioned pressure losses through the valve passageways. The DXJ velocity time integration gives the actual position (XJ) which returns as a feedback on the command comparison element.

5.3 DYNAMIC EQUATION INTEGRATION

The computational algorithm, originally implemented in FORTRAN environment (as shown in table 1), have been also developed in Matlab-Simulink language (one of the most commonly used languages in engineering applications) and it is shown in Figs. 3, 4 and 5.

Both these algorithms are conceived according to the aforesaid physical friction model and to a general layout not so different from the Karnopp's structure; in fact, both of them are divided in two alternative procedures related to the sticking or slipping condition.

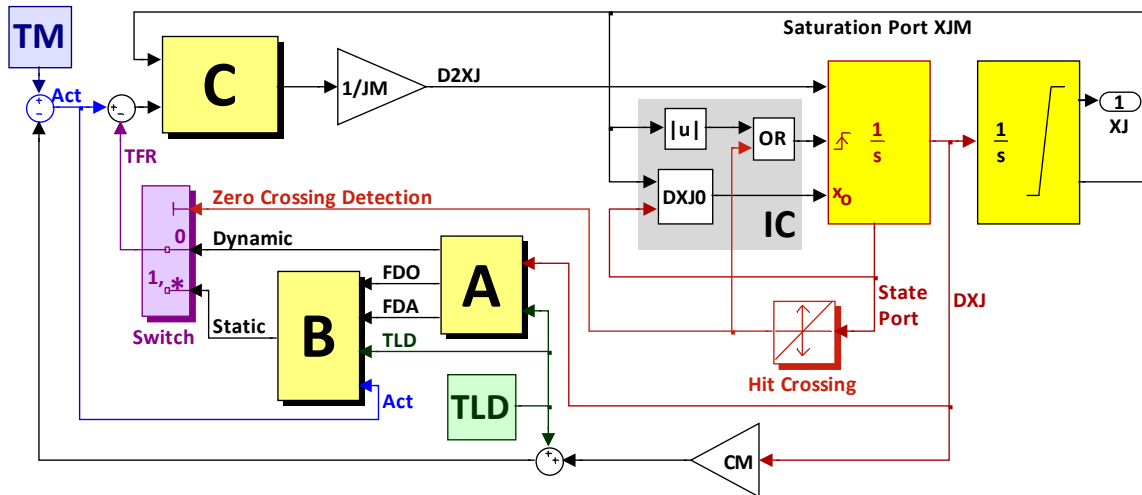

Figure 3 Representation of authors' Matlab- Simulink friction force/torque algorithm.

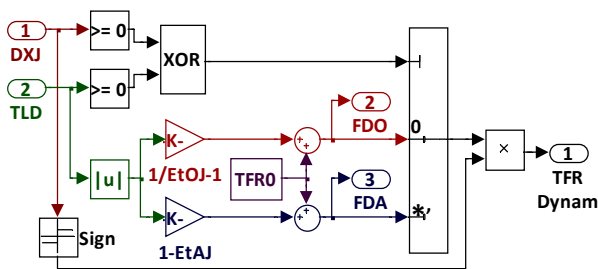

Figure 4 Block A - Representation of dynamic friction force/torque algorithm TFR.

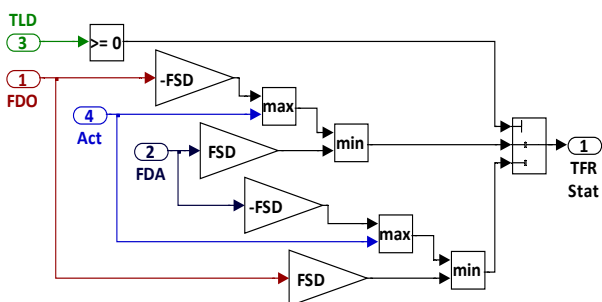

Figure 5 Block A - Representation of static friction force/torque algorithm TFR.

First of all, the algorithm computes the sum Act of the active forces/torques (statement 1 of the computational procedure reported in table 1) and the dynamic values of the friction force/torque (FDO or FDA) as a function of the load T_{LD} in opposing (statement 2) or aiding (statement 3) load run, respectively. The static to dynamic friction ratio

FSD, considered as a constant value in any condition, defines, as a consequence, the static friction values.

In sticking conditions (selected by statement 7), the friction force/torque T_{FR} is considered, by the authors' algorithm, equal to Act and opposing it, but its value must lay within its limits, represented by the static maximum values of friction in eventual opposing ($FSD \cdot FDO$) or aiding ($FSD \cdot FDA$) load breakaway, according to the relative amounts of T_M and T_{LD} (addenda of Act): when T_M is exceeding and opposing T_{LD} , the limit to be assigned to T_{FR} is $FSD \cdot FDO$ (the possible event is the opposing load breakaway), otherwise (T_{LD} exceeding and opposing T_M or aiding it, both exceeding or not) the limit to be considered for T_{FR} is $FSD \cdot FDA$ (possible event: aiding load breakaway), as done in statements 8 or 9 (according to the T_{LD} sense) of the computational routine.

The result is, through the statement 11, an eventual acceleration $D2XJ$ proportional to the eventual excess of Act with respect to the proper T_{FR} limit, having the sense of Act. Synthetically, according to the statements 8 or 9 and 11, the breakaway occurs (in Act sense) only if Act exceeds the proper T_{FR} limit and the excess itself defines slipping condition at the input of the next computational step; otherwise, if Act fails to exceed the T_{FR} limit, no acceleration is performed and the sticking condition persists. In slipping conditions (selected by statement 4), the friction force/torque T_{FR} is considered as the sum of a viscous and a dry (Coulomb, velocity independent) term, opposing the motion; the viscous term is computed, by the coefficient CM, within Act in statement 1, while the dry one is equal to the dynamic value of friction, according to the statements 5 (opposing load run) or 6 (aiding load run).

The result is, by statement 11, an acceleration value $D2XJ$ proportional to the difference between Act and FDO or FDA, having the sense coming from the algebraic difference itself.

By a numerical time integration procedure (as in statement 13, where the simple Euler method is considered), the consequent value of velocity DXJ , characterizing the current step output (considered as input of the following computational step) is computed from the present step input value; the eventual velocity reversion (statements 12 and 14), within the considered computational step (opposite sense between input and output values), must be checked and, if so, the velocity must be imposed equal to zero at the output of the current and so at the input of the next step.

In this way, at the input of the following computational step, the considered mechanical element is necessarily seen in a sticking condition; it seems to be a shortcoming of the algorithm but it is not so. In fact, this measure provides a simple but trouble free method to verify the correct condition (sticking or slipping) to select after a velocity reversion by introducing the computational process into the sticking condition algorithm: so, following the velocity reversion, the sticking condition is maintained if Act is equal or lower than the proper T_{FR} limit or converted into a slipping condition if Act is greater than it. So no specific procedure is necessary for the velocity reversion, having a very small computational error (due to the stop along half computational step, approximately) and no further algorithm burden. The time integration of the velocity DXJ performs the refreshed value of the mechanical element position XJ (statement 15), characterizing the current computational step output (input of the next one), starting from the present step input value. According to the same statement, the mechanical travel is constrained within two hard-stops ($-XJM$, XJM); when a hard-stop is reached, the impact is computed as quite inelastic and, as a consequence, the velocity DXJ is set equal to zero at the output of the current and so at the input of the next step (statements 16 and 17). The same statements allow the eventually correct departure from the considered hard-stop, only preventing negative or positive velocity values when the upper (negative, statement 16) or lower (positive, statement 17) hard-stop is engaged, respectively; the purpose of this computational structure is the prevention of eventually delayed departure from the hard-stop, caused by possible very small computed acceleration values $D2XJ$, in particular conditions.

PROPOSED SIMULINK ALGORITHM: as regards the authors' Simulink algorithm, it is able to simulate the dynamic behaviour of a second order mechanical system computing the proper static/dynamic value of the friction force by means of the blocks A and B (Fig. 4 and 5 respectively) and taking into account the eventual effects of hard-stops. As shown in Fig. 4, the block A (according to statements 2, 3, 5 and 6 of table 1) implements the equations (3) and (4), calculating the dynamic value of the friction force/torque (FDO or FDA) as a function of load

T_{LD} and velocity DXJ ; in particular, such algorithm is able to select between opposing and aiding conditions (employing FDO or FDA by means of the Switch block) and evaluate the correct sign of the so obtained friction force/torque T_{FR} (taking into account the DXJ sign by means of a block implementing the signum function).

Starting from the abovementioned dynamic values of the friction force/torque, the block B (shown in Fig. 5 and according to the statements 8 and 9) computes the related static friction force/torque T_{FR} equal and opposite to Act, but limiting it within the corresponding static maximum values of friction in opposing (FSD·FDO) or aiding (FSD·FDA) conditions.

As regards the breakaway detection (statements 4), the authors' Simulink algorithm implements this routine by means of a switch block that, as a function of instantaneous value of DXJ (coming from the integrator state port), selects among sticking and slipping condition (by means of a hit crossing block) and, so, gives in output the proper value of static or dynamic friction force T_{FR} (Fig. 3).

As shown in Fig. 3, the constrain of the mechanical travel within the hard-stops ($-XJM$, XJM) is achieved limiting opportunely the output of the second integrator (according to statement 15).

The velocity resets, due to the eventual DXJ reversion or engagement of a hard-stop, are performed by means of the joint action of the block IC and C (Fig. 3). The block IC, detecting the DXJ reversion (by means of the hit crossing block) or the hard-stop reaching (detected by means of the saturation port of the integrator), is able to reset the output of the corresponding integrator (statement 14) and, if $XJ=|XJM|$, assign the proper reset DXJ value (statements 16 and 17). The block C, simulating the effect of the hard-stop reaction force, nullify the $D2XJ$ value until the controlled element is pushed against the hard-stop (avoiding undesired integrator windup).

6 SIMULATION RESULTS

In general, as it is well known, when a load is applied to the output side of an irreversible mechanical system, in sticking conditions it develops a friction force/torque having a value potentially exceeding the load itself (actually equal to it, if no driving torque is present on the input side), so preventing any incipient movement (if only the load is applied); otherwise, in slipping conditions, the system develops a friction force/torque actually exceeding the load itself, so progressively stopping the current motion, if no action is applied on the input side of the mechanical system. In sticking conditions, the breakaway is possible or in slipping the motion may persist only as a consequence of a proper driving action applied on the input side. On the contrary, as the reader grasps immediately, if the motion transmission is reversible the load alone, applied on the output side, may be capable of performing the system breakaway in sticking or the motion persistence in slipping conditions.

In the light of these considerations, it is possible to examine closely the simulations results, as follows.

In Figs. 6, 7, 8, 9 and 10 the position command Com is given in form of a step change at time = 0.1 s and a step load T_{LD} is applied from 0 to 74500 N·m at time = 0 s opposing (Figs. 6 and 8) or aiding (Figs. 7, 9 and 10) the commanded actuation rate, respectively. Further, the nominal differential value between supply and return pressures PSR, provided to the servomechanism by the hydraulic system, is set at 26 MPa. This pressure really acts as a constant value at the beginning and at the end of every simulation, whereas, in the central portion of it, a temporary marked pressure drop from 26 to 5 MPa and following recovery to 26 MPa is considered as a hydraulic system malfunctioning, affecting the actuation travel: it is assumed as a continuous time function, having a linear decrease from 26 to 5 MPa since time = 0.3 s till to 0.4 s, followed by 5 MPa constant value and then a linear increase restoring 26 MPa, as a final value, within the time interval 0.6 to 0.8 s.

In Figs. 6 and 8, the position command is given from an initial null position to 1.5 degs.

In Figs. 6 and 7 a reversible mechanical subsystem is assigned to the considered servomechanism, which develops a movement following the step load application, reaching a position error value able to balance the load itself, by means of the servomechanism motor action (produced by its position stiffness) together with the friction torque T_{FR} .

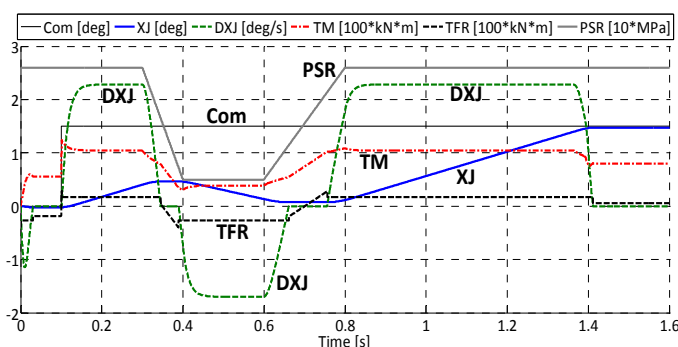

Figure 6 Reversible mechanical subsystem deployment.

In Fig. 6, when the position step command Com is applied, the large error value produces the quick breakaway of the system, overcoming both friction torque and load, consequently reaching a constant actuation rate condition; in it, the action of the hydraulic system differential pressure balances the pressure losses through the servovalve passageways, the viscous friction, the load dependent and independent dry friction and the external load and it is related to the values characterising the motor displacement, the servovalve ends of travel, pressure and flow gains and so on. When the supply pressure drop starts, the actuation rate decreases till to a full system stop.

This sticking condition persists till to the undesired system breakaway developing an actuation rate sense opposing the input command (load exceeding the sum of driving and friction torques); in this condition the authority is acquired by the external load, able to produce an “aiding” movement, overcoming the position command, as a consequence of the motion transmission reversibility, coupled with the very low supply pressure, as it can be expected. When the supply pressure recovery starts, the undesired “aiding” movement decreases till to a new sticking condition, followed by the desired breakaway towards the commanded position. It occurs when the supply pressure is able to produce a driving torque amount exceeding the sum of load and friction torque, so restoring the correct load opposing actuation rate.

All the sticking conditions are characterised by an absolute value of the difference between driving torque T_M and load T_{LD} lower than the maximum static friction torque (opposing if T_M overcomes T_{FR} , aiding if vice versa). At time = 1.41 s the commanded position is reached, having a final “error” caused both by the load and the friction torque.

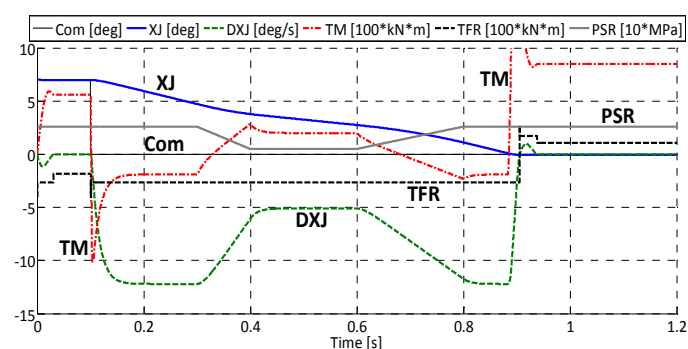

Figure 7 Reversible mechanical subsystem retraction.

In Fig. 7 the position command is given as a step change from an initial 7 degs position to 0 degs, so producing an actuation rate sense characterised by aiding load. Following the position step command application, a constant actuation rate condition is reached; in it, hydraulic system differential pressure PSR and external load balance servovalve passageways pressure losses, viscous friction, load dependent and independent dry friction. When the supply pressure drops, the actuation rate decreases, but no sticking conditions is reached, as a consequence of aiding load and motion transmission reversibility, involving friction torques lower than load actions. When the supply pressure restores the actuation rate increases again till to the previously seen value, so reaching the commanded position at time = 0.94 s. Figures 8, 9 and 10 regard an irreversible mechanical subsystem, assigned to the considered servomechanism which is not interested by any movement following the step load application, having the sole load dependent friction torque the ability to balance the load itself, without servomechanism motor action.

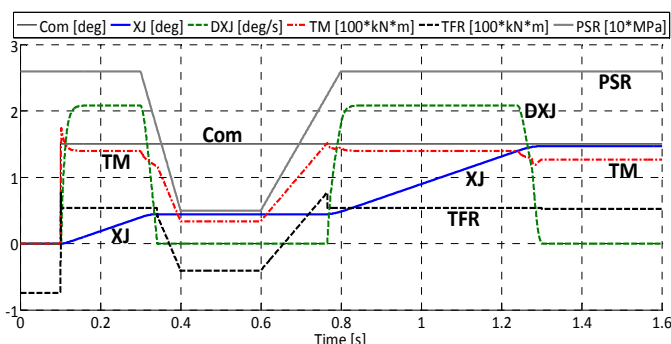

Figure 8 Irreversible mechanical subsystem deployment low “level” of irreversibility ($\eta_{aid} = -0.2$).

In Fig. 8, when the position step command is applied, following a quick acceleration transient, a constant actuation rate condition is reached; in it, the torques balance is quite similar to the case reported in Fig. 6.

When the supply pressure drops, the actuation rate decreases till to a sticking condition, without any back movement aided by the load, because of the mechanical system irreversibility; in fact, the inability of the motor element to balance the load has no effect on the system, because, whatever value the load assumes, the friction torque, produced by the load itself and opposing it, can be eventually greater than it and actually equal to it, so preventing any movement not induced by input side actions. The recovery of the supply pressure performs a new load opposing system breakaway towards the commanded position. It occurs for the same reasons reported in the case of Fig. 6. At time = 1.3 s the commanded position is reached, having a final “error” related both to the load and the friction torque.

In Figs. 9 and 10, the position command Com is given from an initial 4 degs position to 0 degs. Following the position step command application and the consequent quick acceleration transient, a constant actuation rate condition is reached; in it, the torques balance is quite similar to the case considered in Fig. 7.

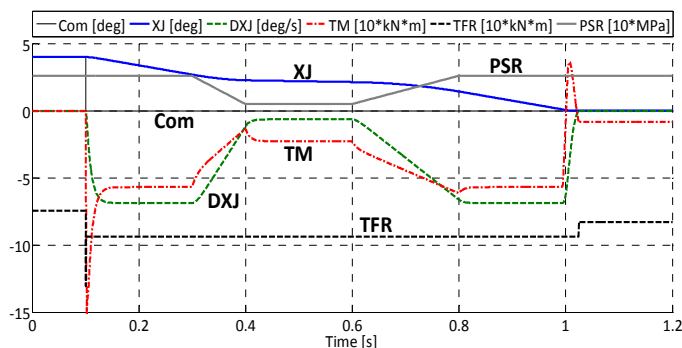

Figure 9 Irreversible mechanical subsystem retraction low “level” of irreversibility ($\eta_{aid} = -0.2$).

In Fig. 9, when the supply pressure drops, the actuation rate decreases, but no sticking condition is reached, as a

consequence of the aiding load, notwithstanding the motion transmission irreversibility; in fact, in this condition, the friction torque is greater than the load, but their net effect is lower than driving torque produced by the differential supply-return pressure PSR so allowing the development of an actuation rate as commanded. It must be noted that the torque related to the pressure losses within the valve passageways produced by the actuation rate, balances the abovementioned torques acting on the mechanical system. This behaviour is related to the low “level” of irreversibility, selected for the present motion transmission ($\eta_{aid} = -0.2$). When the supply pressure restores, the actuation rate increases again till to its initial value, so reaching the commanded position at time = 1.02 s.

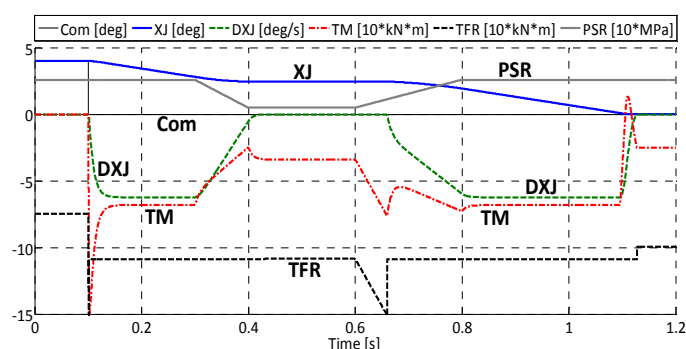

Figure 10 Irreversible mechanical subsystem retraction higher “level” of irreversibility ($\eta_{aid} = -0.4$).

Fig. 10 is quite similar to Fig. 9 apart from the higher “level” of irreversibility of the motion transmission ($\eta_{aid} = -0.4$). In this case, when the supply-return pressure drops, the actuation rate decreases reaching a sticking condition as a consequence of the mechanical irreversibility, notwithstanding the aiding load; in fact, the higher excess of friction torque with respect to the load overcomes the driving torque related to the differential supply-return pressure PSR, so performing a motor stall condition. When PSR restores, the system performs a new breakaway developing the initial actuation rate value and, then, reaching the commanded position at time = 1.28 s. The comparison between Figs. 9 and 10 proves the ability of the algorithm to take correctly into account the effects of the irreversibility “level”, so defining the ratio between friction torque and load in any condition.

In Figs. 11, 12, 13, 14, 15, 16 and 17 the differential supply-return pressure PSR provided to the servomechanism by the hydraulic system is assumed equal to its 26 MPa nominal value along the whole simulation time.

In Figs. 11, 12 and 13 a step load T_{LD} is applied from 0 to 74500 N·m at time = 0.02 s, restoring 0 N·m at 0.2 s by a second step change; the actual initial position is set at 0.1 degs and the related command keeps the same value till to time = 0.07 s; then, a position ramp command follows from 0.1 degs, at time = 0.07 s, characterised by -0.5 degs/s slope.

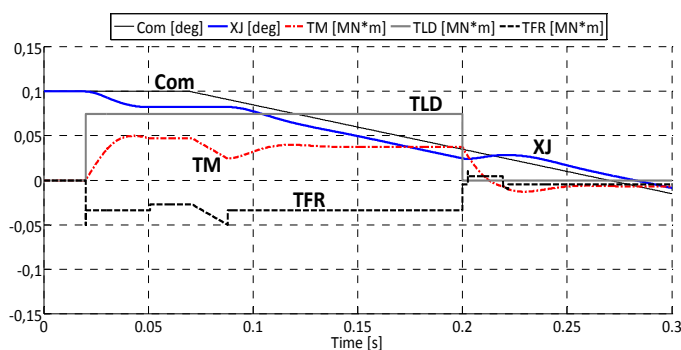

Figure 11 Reversible mechanical subsystem retraction PSR nominal value (26 MPa) and T_{LD} step load.

Fig. 11 regards a servomechanism equipped with reversible mechanical subsystem; it develops, at time = 0.02 s, a movement following the first step load application reaching a position error value able to balance the load itself by the motor action and the friction torque.

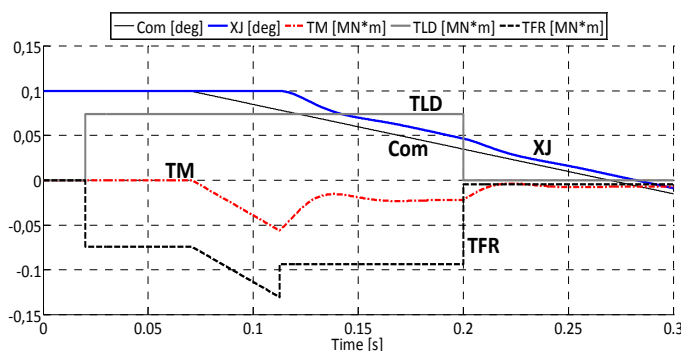

Figure 12 Irreversible mechanical subsystem retraction PSR nominal value (26 MPa) and T_{LD} step load.

Fig. 12 shows the irreversible mechanical subsystem behaviour, performing no movement in the same step load conditions, as it can be expected. When the position ramp command Com starts, the system breakaway occurs following a defined time delay (resolution), due to the small, but variable, initial error value together with the static friction torque; the system moves when the driving torque, related to the abovementioned position error, overcomes the net torque between static friction and load.

It must be noted that, having the ramp command a negative slope and the servomechanism purely proportional control law, the reversible (Fig. 11) or irreversible (Fig. 12) system breakaway occurs starting from a positive (Fig. 11) or negative (Fig. 12) value of position error. In no load conditions the sign of the position error must be the same of the ramp command slope (ComR): if the net effect between load and torques connected to viscous effects, friction and pressure losses across the valve (small actuation rate) aids the commanded movement (situation necessarily connected to an aiding load acting on a reversible mechanical system),

the slope and position error signs are opposite (as shown in Fig. 11 till to time = 0.2 s).

The system irreversibility (as in Fig. 12) produces the opposite behaviour, as a consequence of the excess of the friction torque with respect to the load. As previously reported, when the load value returns to 0 N·m (time \geq 0.2 s), both the reversible and irreversible systems develop position error having the same sign of ComR, as it can be expected and it is correctly shown in Figs. 11 and 12.

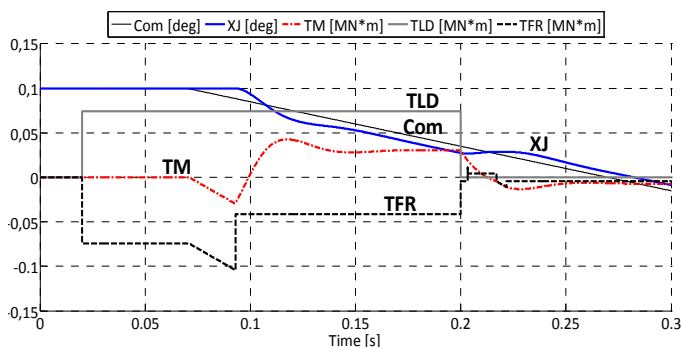

Figure 13 Statically irreversible / dynamically reversible mechanical subsystem retraction

Fig. 13 is referred to a particular but possible behaviour of the mechanical subsystem: the efficiency in dynamic aiding condition is defined as positive (dynamically reversible system), but the ratio between static and dynamic friction torque is assumed sufficiently high to perform a static friction torque exceeding the corresponding load (while the dynamic one is lower). In fact, as clearly shown in Fig. 13, the position error in breakaway condition is proper of an irreversible system, but, in steady state, the behaviour is characteristic of a reversible one.

It must be noted that, also in this case, the authors' computational algorithm is quite able to correctly reproduce the expected behaviour: in fact, in aiding conditions, the average position error sense concerning the reversible system is the opposite of the required actuation rate, because of its positive value of efficiency, involving friction torques (opposing) lower than the related load ones (aiding), thus producing an aiding net torque, requiring a braking action to the hydraulic motor. Therefore, the position error must oppose the commanded movement if the aiding net torque exceeds the braking action represented by the viscous damping of the mechanical subsystem and mainly by the pressure losses through the valve passageways related to the flow required by the motor speed. Instead, in case of irreversible system, the average position error sense is the same of the required actuation rate, because of its negative value of efficiency, involving friction torques (opposing) exceeding the related load ones (aiding), thus producing an opposing net torque, requiring a driving action to the hydraulic motor; therefore, the position error must aid the commanded movement.

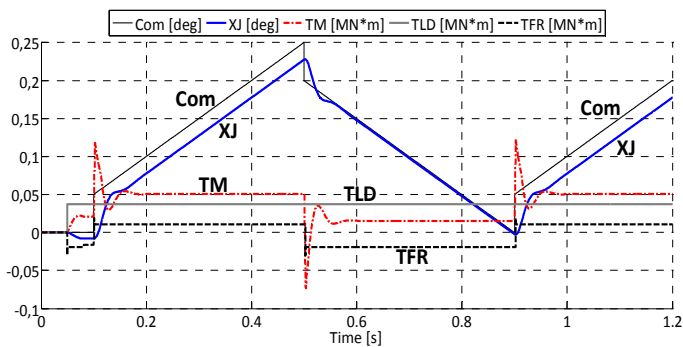

Figure 14 Reversible mechanical subsystem actuation.

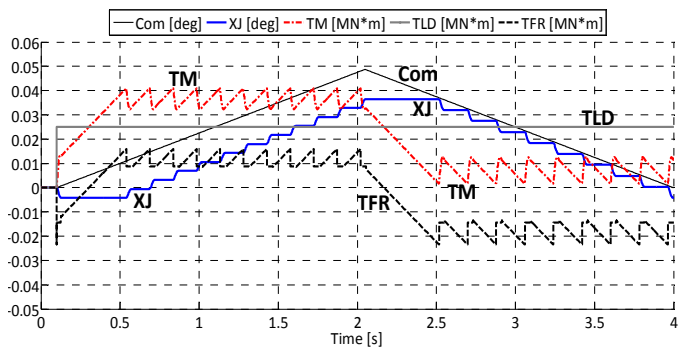

Figure 16 Reversible mechanical subsystem actuation.

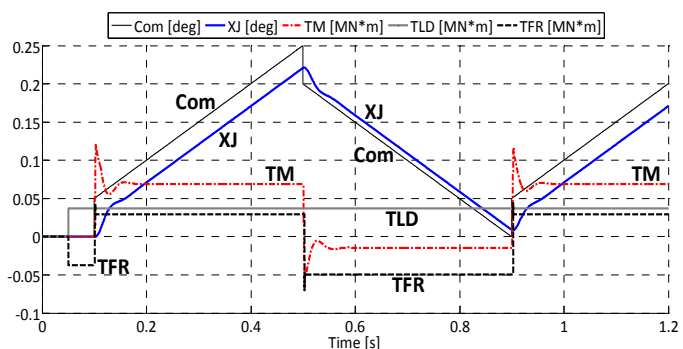

Figure 15 Irreversible mechanical subsystem actuation.

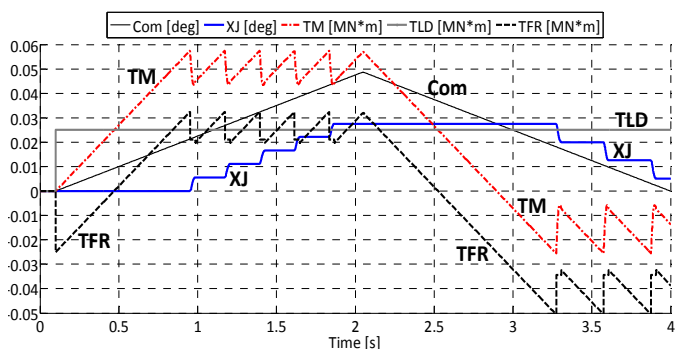

Figure 17 Irreversible mechanical subsystem actuation.

In Figs. 14 and 15 a step load is applied from 0 to 37243 N·m at time = 0.1 s, keeping it constant till to the simulation end; the actual initial position is set at 0 degs and the same value is given to the command, constant till to time = 0.1 s, in which time a position step command of 0.05 degs is applied. Then a position ramp command follows from 0.05 degs at time = 0.1 s having a growth rate of 0.5 degs/s till to 0.5 s. At time = 0.5 s a step command of -0.05 degs is applied, the followed by a decrease of -0.5 degs/s till to 0.9 s. Successively, the sequence from 0.1 s to 0.9 s is repeated. The step position commands applied at the beginning of each ramp has the purpose of producing a brief transient to the steady-state ramp response and, so, removing the behaviour difference between reversible and irreversible system in break-away condition.

The comparison between Figs. 14 and 15 shows that the delay between commanded and actual position is lower in case of a reversible than irreversible system (eventually opposite to the commanded actuation rate when the load is aiding); the detailed view in Fig. 14 puts in evidence that the actual position leads the commanded one in condition of steady-state low rate ramp command when the system is reversible and the load aids the motion. It must be noted that the examined situation is the consequence of properly low actuation rate (but higher enough to prevent stick-slip), sufficiently high value of aiding load T_{LD} and low value of load independent friction force.

In Figs. 16 and 17 a step load is applied from 0 to 25000 N·m at time = 0.1 s, keeping it constant till to the simulation end; the actual initial position is set at 0 degs and the same value is given to the command, constant till to time = 0.1 s. Then a position ramp command follows from 0 degs at time = 0.1 s having a growth rate of 0.025 degs/s till to 2.05 s, followed by a decrease of -0.025 degs/s. In these cases the required actuation rate is sufficiently low to perform a stepping dynamic response (stick-slip) as a consequence of the difference between static and dynamic friction forces.

In general, the operative conditions having a lower value of efficiency are characterized by higher steps and (as a consequence of a defined input ramp slope) longer period. In fact, low efficiency involves large values of friction force/torque related to a given external load, so performing high difference between its static and dynamic values, for a defined FSD (static/dynamic) ratio.

According to these considerations, as it can be observed in Figs. 16 and 17, having the same data set, the irreversible system is characterised by higher steps than the reversible one; further, the aiding load travel performs higher steps than the opposing one.

Consequently, the comparison between Figs. 16 and 17 puts in evidence higher values of average position error regarding the irreversible system than the reversible one along the actuation travel in opposing conditions, as a result of its lower efficiency.

7 CONCLUSIONS

The simulations show the proper accuracy of the proposed algorithm taking into account the effects of the dry friction and of the ends of travel on the behaviour of the actuators. It must be noted the ability of the proposed model to describe correctly the dynamic/static behaviour of both reversible and irreversible types, employing the proper values of the respective efficiencies.

So, the algorithm developed by the authors supplies an effective answer to the necessity of accurate tools in evaluating the effects produced by friction forces or torques and ends of travel acting on a generic mechanical device, as an actuator, by means of a self-contained Simulink computational routine.

8 TABLE 1:

FORTRAN Listing of the Authors' Friction Algorithm

```

01 - Act =TM-TLD-CM-DXJ
02 - FDO=TFR0+(1/EtO-1)*ABS(TLD)
03 - FDA=TFR0+(1-EtA)*ABS(TLD)
04 - IF(DXJ.NE.0.) THEN
05 -   TFR=SIGN(FDO,DXJ)
06 -   IF(DXJ.FR.LT.0.) TFR=SIGN(FDA,DXJ)
07 - ELSE
08 -   TFR=MIN(MAX(-FSD-FDA,Act),FSD-FDO)
09 -   IF(TLD.LT.0.) TFR=MIN(MAX(-FSD-FDO,Act),FSD-FDA)
10 - ENDIF
11 - D2XJ = (Act-TFR)/JM
12 - Old = DXJ
13 - DXJ = DXJ+D2XJ*DT
14 - IF (Old-DXJ.LT.0) DXJ = 0
15 - XJ=MIN(MAX(-XJM, XJ+(Old+DXJ)*DT/2),XJM)
16 - IF(XJ.EQ.-XJM) DXJ=MAX(0.,DXJ)
17 - IF(XJ.EQ.XJM) DXJ=MIN(DXJ,0.)

```

9 LIST OF SYMBOLS

Act sum of the active torques
CM viscous damping coefficient of the system
Com input command
D2XJ controlled element angular acceleration
DXJ controlled element angular rate
FSD static to dynamic friction ratio
JM moment of inertia of the system
PSR differential supply-return pressure
T_{LD} aerodynamic load acting on the surface
T_{FR} friction torque
T_{FRO} load independent friction torque component
T_{FRL} load dependent friction torque component
T_M motor torque
XF servovalve first stage flapper position
XJ controlled element angular position
XS servovalve second stage spool position
 η general out/in torque ratio
 η_{opp} out/in torque ratio, opposing load
 η_{aid} out/in torque ratio, aiding load

10 LIST OF SYMBOLS USED IN TABLE 1

EtA = η_{aid}
 EtO = η_{opp}
 FDA dynamic friction torque, aiding load
 FDO dynamic friction torque, opposing load
 TFR = T_{FR}
 TFR0 = T_{FRO}
 TLD = T_{LD}
 TM = T_M

11 LITERATURE

- [1] Borello L., Villero G., Flap control system actuators: mathematical and computational model for dynamic simulation, *European Congress on Computational Methods in Applied Sciences and Engineering ECCOMAS 2000*, Barcellona, Spain, 11-14 September 2000.
- [2] Borello L., Dalla Vedova M. Load dependent coulomb friction: a mathematical and computational model for dynamic simulation in mechanical and aeronautical fields. *International Journal of Mechanics and Control (JoMaC)*, Vol. 07, No. 01, pp. 19-30, 2006.
- [3] Karnopp D., Computer simulation of stick-slip friction in mechanical dynamic systems, *Journal of Dynamic Systems, Measurement, and Control*, Vol. 107, pp. 100-103, March 1985.
- [4] Quinn D. D., A new regularization of Coulomb friction," *Trans. Of ASME: Journal of Vibration and Acoustics*, vol. 126, no. 3, pp. 391-397, 2004.
- [5] Kikuuwe R., Takesue N., Sano A., Mochiyama H., Fujimoto H., Fixed-step friction simulation: from classical coulomb model to modern continuous models, *International Conference on Intelligent Robots and Systems IEEE/RSJ 2005*, pp. 3910-3917, June 2005.
- [6] Dupont, P., Armstrong, B., Hayward, V., Elasto-plastic friction model: contact compliance and stiction, *Proceedings of the American Control Conference*, vol.2, pp. 1072 - 1077, June 2000.

TEMPLATE FOR PREPARING PAPERS FOR PUBLISHING IN INTERNATIONAL JOURNAL OF MECHANICS AND CONTROL

Author1* Author2**

* affiliation Author1

** affiliation Author2

ABSTRACT

This is a brief guide to prepare papers in a better style for publishing in International Journal of Mechanics and Control (JoMaC). It gives details of the preferred style in a template format to ease paper presentation. The abstract must be able to indicate the principal authors' contribution to the argument containing the chosen method and the obtained results. (max 200 words)

Keywords: keywords list (max 5 words)

1 TITLE OF SECTION (E.G. INTRODUCTION)

This sample article is to show you how to prepare papers in a standard style for publishing in International Journal of Mechanics and Control.

It offers you a template for paper layout, and describes points you should notice before you submit your papers.

2 PREPARATION OF PAPERS

2.1 SUBMISSION OF PAPERS

The papers should be submitted in the form of an electronic document, either in Microsoft Word format (Word'97 version or earlier).

In addition to the electronic version a hardcopy of the complete paper including diagrams with annotations must be supplied. The final format of the papers will be A4 page size with a two column layout. The text will be Times New Roman font size 10.

Contact author: author1¹, author2²

¹Address of author1.

²Address of author2 if different from author1's address.

2.2 DETAILS OF PAPER LAYOUT

2.2.1 Style of Writing

The language is English and with UK/European spelling.

The papers should be written in the third person. Related work conducted elsewhere may be criticised but not the individuals conducting the work. The paper should be comprehensible both to specialists in the appropriate field and to those with a general understanding of the subject.

Company names or advertising, direct or indirect, is not permitted and product names will only be included at the discretion of the editor. Abbreviations should be spelt out in full the first time they appear and their abbreviated form included in brackets immediately after. Words used in a special context should appear in inverted single quotation mark the first time they appear. Papers are accepted also on the basis that they may be edited for style and language.

2.2.2 Paper length

Paper length is free, but should normally not exceed 10000 words and twenty illustrations.

2.2.3 Diagrams and figures

Figures and Tables will either be entered in one column or two columns and should be 80 mm or 160 mm wide respectively. A minimum line width of 1 point is required at actual size. Captions and annotations should be in 10 point with the first letter only capitalised *at actual size* (see Figure 1 and Table VII).

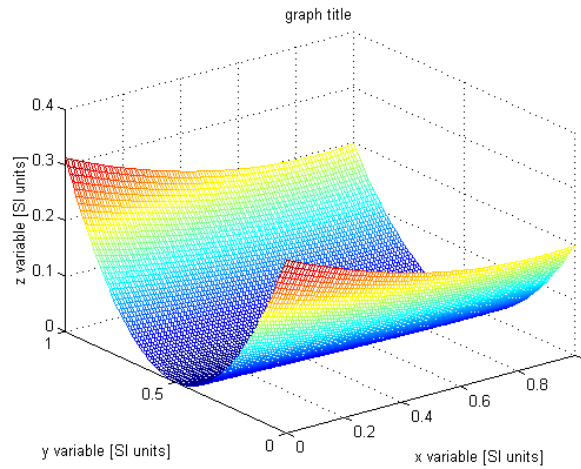

Figure 1 Simple chart.

Table VII - Experimental values

Robot Arm Velocity (rad/s)	Motor Torque (Nm)
0.123 10.123	
1.456 20.234	
2.789 30.345	
3.012 40.456	

2.2.4 Photographs and illustrations

Authors could wish to publish in full colour photographs and illustrations. Photographs and illustrations should be included in the electronic document and a copy of their original sent. Illustrations in full colour ...

2.2.5 Equations

Each equation should occur on a new line with uniform spacing from adjacent text as indicated in this template. The equations, where they are referred to in the text, should be numbered sequentially and their identifier enclosed in parenthesis, right justified. The symbols, where referred to in the text, should be italicised.

- point 1
 - point 2
 - point 3
- 1. numbered point 1
- 2. numbered point 2
- 3. numbered point 3

$$W(d) = G(A_0, \sigma, d) = \frac{1}{T} \int_0^{+\infty} A_0 \cdot e^{-\frac{d^2}{2\sigma^2}} dt \quad (1)$$

3 COPYRIGHT

Authors will be asked to sign a copyright transfer form prior to JoMaC publishing of their paper. Reproduction of any part of the publication is not allowed elsewhere without permission from JoMaC whose prior publication must be cited. The understanding is that they have been neither previously published nor submitted concurrently to any other publisher.

4 PEER REVIEW

Papers for publication in Jo MaC will first undergo review by anonymous, impartial specialists in the appropriate field. Based on the comments of the referees the Editor will decide on acceptance, revision or rejection. The authors will be provided with copies of the reviewers' remarks to aid in revision and improvement where appropriate.

5 REFERENCES (DESCRIPTION)

The papers in the reference list must be cited in the text. In the text the citation should appear in square brackets [], as in, for example, "the red fox has been shown to jump the black cat [3] but not when...". In the Reference list the font should be Times New Roman with 10 point size. Author's first names should be terminated by a 'full stop'. The reference number should be enclosed in brackets. The book titles should be in *italics*, followed by a 'full stop'. Proceedings or journal titles should be in *italics*. For instance:

REFERENCES (EXAMPLE)

- [1] Smith J., Jones A.B. and Brown J., *The title of the book*. 1st edition, Publisher, 2001.
- [2] Smith J., Jones A.B. and Brown J., The title of the paper. *Proc. of Conference Name*, where it took place, Vol. 1, paper number, pp. 1-11, 2001.
- [3] Smith J., Jones A.B. and Brown J., The title of the paper. *Journal Name*, Vol. 1, No. 1, pp. 1-11, 2001.
- [4] Smith J., Jones A.B. and Brown J., *Patent title*, U.S. Patent number, 2001.

International Journal of Mechanics and Control – JoMaC
Published by Levrotto&Bella
TRANSFER OF COPYRIGHT AGREEMENT

<p>NOTE: Authors/copyright holders are asked to complete this form signing section A, B or C and mail it to the editor office with the manuscript or as soon afterwards as possible.</p>	<p><i>Editor's office address:</i> Andrea Manuello Bertetto Elvio Bonisoli <i>Dept. of Mechanics</i> <i>Technical University – Politecnico di Torino</i> <i>C.so Duca degli Abruzzi, 24 – 10129 Torino – Italy</i> <i>e_mail: jomac@polito.it</i> <i>fax n.: +39.011.564.6999</i></p>
--	---

The article title:

By: _____

To be Published in *International Journal of Mechanics and Control JoMaC*
Official legal Turin court registration Number 5320 (5 May 2000) - reg. Tribunale di Torino N. 5390 del 5 maggio 2000

- A Copyright to the above article is hereby transferred to the JoMaC, effective upon acceptance for publication. However the following rights are reserved by the author(s)/copyright holder(s):
1. All proprietary rights other than copyright, such as patent rights;
 2. The right to use, free or charge, all or part of this article in future works of their own, such as books and lectures;
 3. The right to reproduce the article for their own purposes provided the copies are not offered for sale.
- To be signed below by all authors or, if signed by only one author on behalf of all co-authors, the statement A2 below must be signed.*

A1. All authors:

SIGNATURE _____ DATE _____ SIGNATURE _____ DATE _____

PRINTED NAME _____ PRINTED NAME _____

SIGNATURE _____ DATE _____ SIGNATURE _____ DATE _____

PRINTED NAME _____ PRINTED NAME _____

A2. One author on behalf of all co-authors:

"I represent and warrant that I am authorised to execute this transfer of copyright on behalf of all the authors of the article referred to above"

PRINTED NAME _____

SIGNATURE _____ TITLE _____ DATE _____

B. The above article was written as part of duties as an employee or otherwise as a work made for hire. As an authorised representative of the employer or other proprietor. I hereby transfer copyright to the above article to *International Journal of Mechanics and Control* effective upon publication. However, the following rights are reserved:

1. All proprietary rights other than copyright, such as patent rights;
2. The right to use, free or charge, all or part of this article in future works of their own, such as books and lectures;
3. The right to reproduce the article for their own purposes provided the copies are not offered for sale.

PRINTED NAME _____

SIGNATURE _____ TITLE _____ DATE _____

C. I certify that the above article has been written in the course of employment by the United States Government so that no copyright exists, or by the United Kingdom Government (Crown Copyright), thus there is no transfer of copyright.

PRINTED NAME _____

SIGNATURE _____ TITLE _____ DATE _____

CONTENTS

- 3 Modelling and Temperature Control of Shape Memory Alloys with Fast Electrical Heating**
R. Velázquez and E.E. Pissaloux
- 11 Vehicles Headlamps Glare Effect Removal**
G. Ligios and A. Manuello Bertetto
- 37 A Dry Friction Model and Robust Computational Algorithm for Reversible or Irreversible Motion Transmissions**
L. Borello and M.D.L. Dalla Vedova
- 49 Design Procedure of a Breech Mechanism with Double Helix Shaft**
C. Delprete, E. Bonisoli and D. Tomasi
- 57 Modular Reconfigurable Anthropomorphic Gripper with Three Fingers for Robots-Design, Prototype and Simulation**
C.C. Moldovan and I. Staretu
- 63 Velomobiles: Design Guidelines**
P. Baldissera, C. Delprete and M. Tirelli
- 73 A Methodology to Design Robotic Arms for Service Tasks since Early Design Stage**
C. Castejón, G. Carbone, J.C. García-Prada and M. Ceccarelli
- 85 Vehicle Parameters Identification and States Estimation**
D. Capra, M. Velardocchia and A. Vigliani
- 91 Application of a New Tailoring Optimization Technique to Laminated and Sandwich Plates and to Sandwich Spherical Panels**
U. Icardi and F. Sola
- 107 Static and Low Frequency Evaluation of a Thin-Film Contact Force Sensor**
A. Manuello Bertetto and S. Meili