

On-site testing of sutured organs: An experimental set up to cyclically tighten sutures

*Original*

On-site testing of sutured organs: An experimental set up to cyclically tighten sutures / Pascoletti, G.; Pressanto, M. C.; Putame, G.; Terzini, M.; Audenino, A. L.; Zanetti, E. M.. - In: JOURNAL OF THE MECHANICAL BEHAVIOR OF BIOMEDICAL MATERIALS. - ISSN 1751-6161. - ELETTRONICO. - 109:(2020), p. 103803.  
[10.1016/j.jmbbm.2020.103803]

*Availability:*

This version is available at: 11583/2827735 since: 2020-05-21T09:30:47Z

*Publisher:*

Elsevier Ltd

*Published*

DOI:10.1016/j.jmbbm.2020.103803

*Terms of use:*

This article is made available under terms and conditions as specified in the corresponding bibliographic description in the repository

*Publisher copyright*

Elsevier postprint/Author's Accepted Manuscript

© 2020. This manuscript version is made available under the CC-BY-NC-ND 4.0 license  
<http://creativecommons.org/licenses/by-nc-nd/4.0/>. The final authenticated version is available online at:  
<http://dx.doi.org/10.1016/j.jmbbm.2020.103803>

(Article begins on next page)

# On-site testing of sutured organs: an experimental set up to cyclically tighten sutures

## 1. Abstract

A number of surgical practices are aimed to compensate for tissue relaxation or weakened/atrophied muscles by means of suture prostheses/thread lifts. The success rate of these procedures is often very good in the short term, while it is quite variable among subjects and techniques in the middle-long term. Middle-long term failures are mostly related to suture distraction, loosening or wear, coming from repeated loading cycles.

In this work, an experimental device to perform ex vivo tests on prosthetic sutures has been set up. An equine laryngoplasty has been used as a benchmark, being representative of sutures aimed to compensate for atrophied muscles. The peculiarity of this experimental set up is that the suture is on-site and it has been tightened with known, repeated loads, which do not depend on thread deformation at different load levels. Preliminary tests have been performed applying over 3000 load cycles and finally a tensile test up to rupture.

Force/displacement curves obtained with this experimental set up have been reported and parameters useful to classify the biomechanical performance of sutures versus time (mainly its creep behaviour), have been outlined.

Results have outlined that the organ-suture system undergoes significant creep over 3000 cycles, and this should be taken into account in order to foresee its long-term behaviour; in addition, the suture anchorage to cartilage should be improved.

The experimental set up can be used to perform on-site testing of sutures, taking into account the compliance and creep response at both suture anchorage ends, in order to compare different surgeries and different kinds of thread.

**Keywords:** suture testing; distraction; failure; creep; neuropathy; tissue relaxation

## 2. Introduction

There is a number of applications in the medical practice where localised loads are provided by tensioned sutures. With reference to aesthetic surgery for example, thread lifts are gaining popularity as an alternative to traditional surgical rhytidectomy or neck lifting, thanks to their limited invasiveness[1]. With reference to otorhinolaryngology, sling arytenoid adduction [2] has been introduced as an innovative technique for the vocal process repositioning. Similarly, a simple suture is used in arytenoid abduction lateropexy to treat neonatal unilateral vocal cord paralysis [3]. Silicone rods or polytetrafluoroethylene (PTFE) sutures are used for frontalis suspension in blepharoptosis [4,5], and PTFE sutures can be used for mitral leaflet prolapse [6]. Other applications, even more demanding from the biomechanical point of view, concern prolapse repair such as pelvic organ prolapses [7,8]. The immediate efficacy of these practices has been supported by rigorous clinical data; however, the respective middle-long-term behaviour is often a cause of concern [9–12] and has driven the development of new solutions. These new solutions concern not only the surgical technique, but also the suture material (resorbable/non-resorbable, silicone, PTFE, ethibond, fascia lata, polyamide, silk etc. [13,14]), the thread geometry (see, for example, barbed/non-barbed sutures [15]), and the suture fixation (single/double loop [16], suture buttons or suture anchors [16]). Pre-clinical testing of these solutions can give quantitative data in order to establish the respective performance and indications. However, the greatest parts of these tests are designed to measure the ultimate load to failure, and there are few data

concerning the suture wear and creep behaviour. In addition, the behaviour of the entire system made of the suture and its anchorage points must be taken into account.

A dedicated experimental set up has been here developed whose main peculiarities are: working on the whole sutured organ and allowing the application of repeated, known loads along the suture. It can be used to study various tensile sutures, and it has been here used to test the equine laryngoplasty, used as a benchmark, being representative of sutures aimed to compensate for atrophied muscles. The loading fixture has been described in detail, and some preliminary results have been reported to support the hypothesis that the mechanical behaviour of the suture-organ system undergoes major changes when subjected to repeated loading cycles; the assessment of this trend is mandatory in order to forecast its long-term performances. For most applications, this assessment cannot be deduced from the behaviour of the thread alone since both anchorage points have a role, as here demonstrated, therefore 'on-site suture testing' is recommendable and a methodology to do this is here introduced. As a result of the experimental analysis, relevant mechanical properties which have good repeatability have been individuated (standard error below 10%), and some recommendations concerning the surgery have been outlined.

### 3. Materials and methods

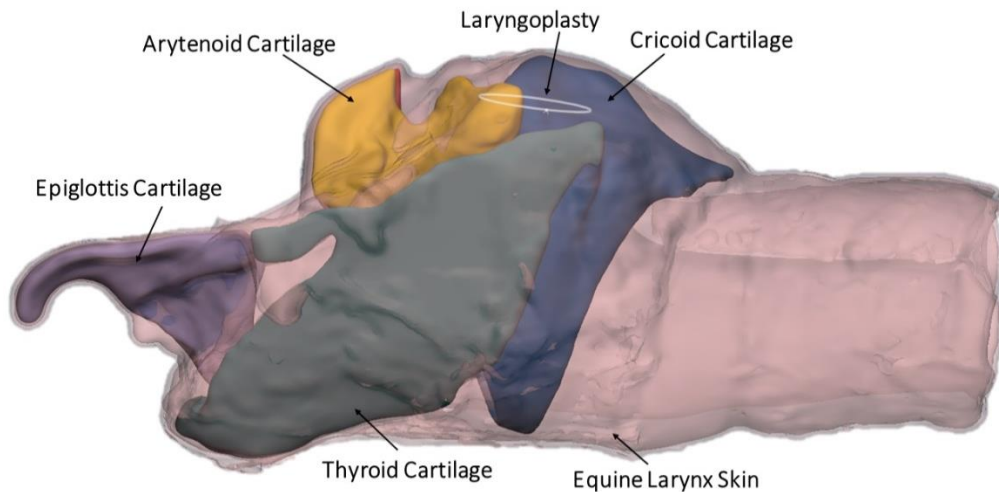

Figure 1. The equine laryngoplasty: a suture is placed between the cricoid and the arytenoid cartilages in order to keep the second one in an abducted position

#### Specimens

The loading system has been used to test 8 equine larynges as a benchmark; these larynges were collected from a local abattoir and frozen. They belonged to 5 male and 3 female horses, aged between 3 and 13 years old. At time of testing, the larynges were thawed at ambient temperature and a veterinary surgeon performed laryngoplasty, according to the 'standard' technique described in [17]. The equine laryngoplasty is performed through a prosthetic suture placed between the cricoid cartilage and the muscular process of the arytenoid cartilage, which has the function of replacing the tensile action of the cricoarytenoideus dorsalis muscle, achieving a permanent abduction of the respective arytenoid cartilage (Figure 1). The most common postoperative complication of this surgery takes place in the first few weeks after surgery [18] and it leads to the loss of adduction. According to some authors, the main cause of failure is related to cartilage failure [19]; other authors postulated the loss of adduction is more frequently related to suture displacement or to cartilage deformation [20]; finally, a further failure mode is related to a worn suture tear [17]. Performing experimental tests *ex vivo* on larynges subjected to

laryngoplasty can give a substantial support to the analysis of the causes of the loss of abduction and to plan possible countermeasures.

### Suture Loads

The load was provided by a universal testing machine: Instron Electropulse E3000, which allowed performing both cyclic and tensile tests in displacement control (1 mm/s); it has been equipped with Dynacell biaxial dynamic load cell (axial load range  $\pm 5$  kN; accuracy equal to 0.10% in the 0-60 N load range here used, according to the most recent calibration curve). With reference to cyclic tests, the lower and upper load limits have been chosen so as to reproduce loads taking place during physiological loads such as swallowing in the present example [21]: the suture tensile load was cycled between 30 N and 50 N; these tests lasted over 3000 loading cycles at frequencies ranging between 0.8 and 2 Hz (depending on the organ-suture system compliance). At the end of cyclic tests, the laryngoplasty was tested up to rupture, working at a constant displacement rate equal to 1 mm/s, according to previous works in literature [17,20,22,23].

### The organ support

The organ support has been designed to securely constrain the organ through bolts; it bears many holes in order to allow the optimization of organ positioning and orientation, according to its size and peculiar shape. The system can be simply placed above the loading machine base, its stability being guaranteed by its own weight (greater than 20 kg).

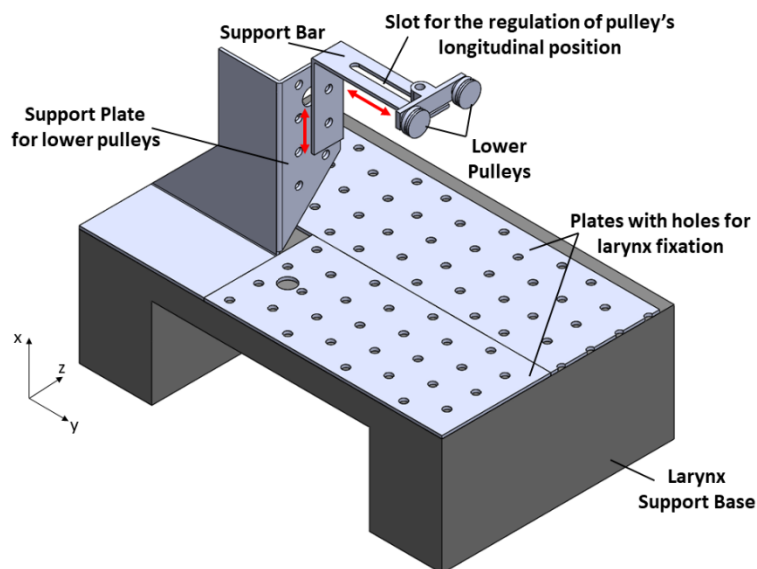

Figure 2. The organ support base

A 'support plate' is soldered on this base (Figure 2); it bears the 'support bar' whose height (that is vertical location along x axis) and position (that is horizontal location along z axis) can be regulated at fixed step. Finally, this bar supports the 'lower pulleys', through a slot which allows a continuous regulation along the y axis.

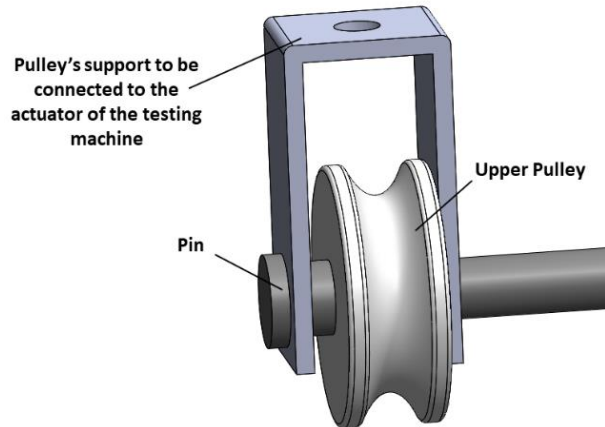

Figure 3. The upper pulley

### The upper pulley

An upper pulley is bounded to the movable crosshead of the universal loading machine (Figure 3). The outer diameter of this pulley is equal to the distance between the two lower pulleys centre minus the respective diameter.

### Suture Loading

Equilibrium equations applied to this loading system (Figure 4) for two different force levels result in:

$$F_1 = 2T_1 \Rightarrow T_1 = \frac{F_1}{2} \quad (1)$$

$$F_2 = 2T_2 \Rightarrow T_2 = \frac{F_2}{2} \quad (2)$$

Where:

- $F_i$  is the vertical force applied by the testing machine at the exact centre of the upper pulley;
- $T_i$  is the tension of the thread.

Eq (1) and Eq (2) hold if:

- the upper pulley is perfectly centred between the two lower pulleys
- all pulleys can rotate without any friction
- the inertia of pulleys can be neglected.

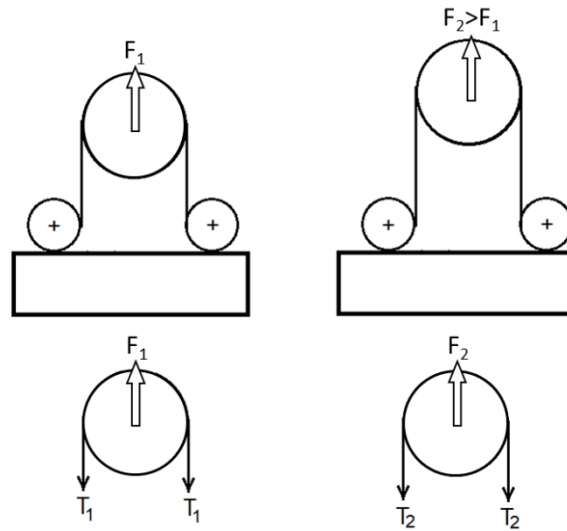

Figure 4. Static analysis for the lower and upper pulley system

The loading system guarantees that the suture thread tension depends exclusively on the applied force, being equal to its half; in other words, whenever the applied force is well known, the thread tension can be easily calculated.

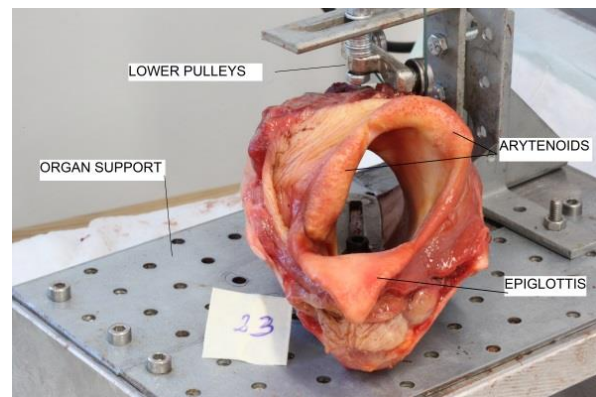
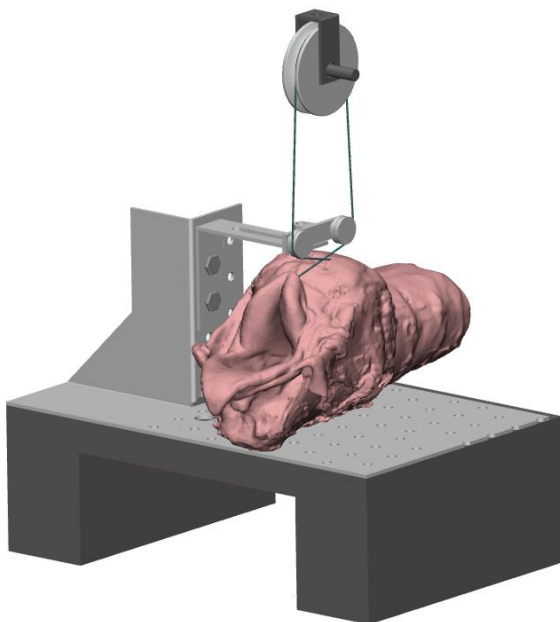

Figure 5. Designed loading system with larynx (left) and actual loading system with larynx (right)

#### 4. Results and discussion

All constructs completed the cyclic loading without evidence of failure.

Figure 6 reports typical curves obtained for both loading protocols. With reference to cyclic tests, a creep behaviour of the sutured organ is quite evident: the average displacement grows as the test goes on. This could be due to the progressive migration of the suture, creep taking place inside soft tissues, creep occurring inside the suture thread. The last hypothesis has been tested submitting the thread at the same cyclic load as the sutured organ: the respective creep rate was less than 1/10 the measured creep rate for the suture-organ system. The visual observation of

tissues at the end of 3000 consecutive cycles has also led to exclude the hypothesis of a progressive migration of the suture. At the end, the most likely hypothesis was that the soft tissue has a creep response behaviour; the measurement of this response is a key factor in determining the long-term behaviour of the suture-organ system. The analysis of curves reported in Figure 6, allows the assessment of some descriptive parameters:

- $S$  that is the slope of the line interpolating the asymptotic displacement trend (the black line in Figure 6b) which gives an index of the creep rate;
- $k_i$  that is average stiffness behaviour for  $i$ th cycle (Figure 6d), and  $k_{ave}$  that is its average value over 3000 cycles;
- $D$  that is the total distraction in 3000 cycles; this is an output often reported in literature (Figure 6b).

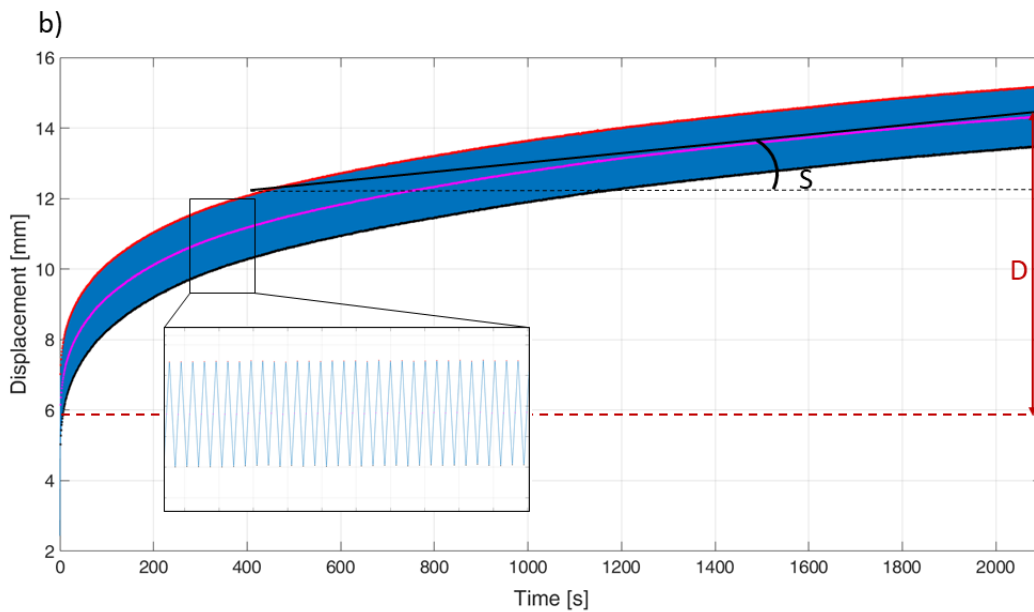
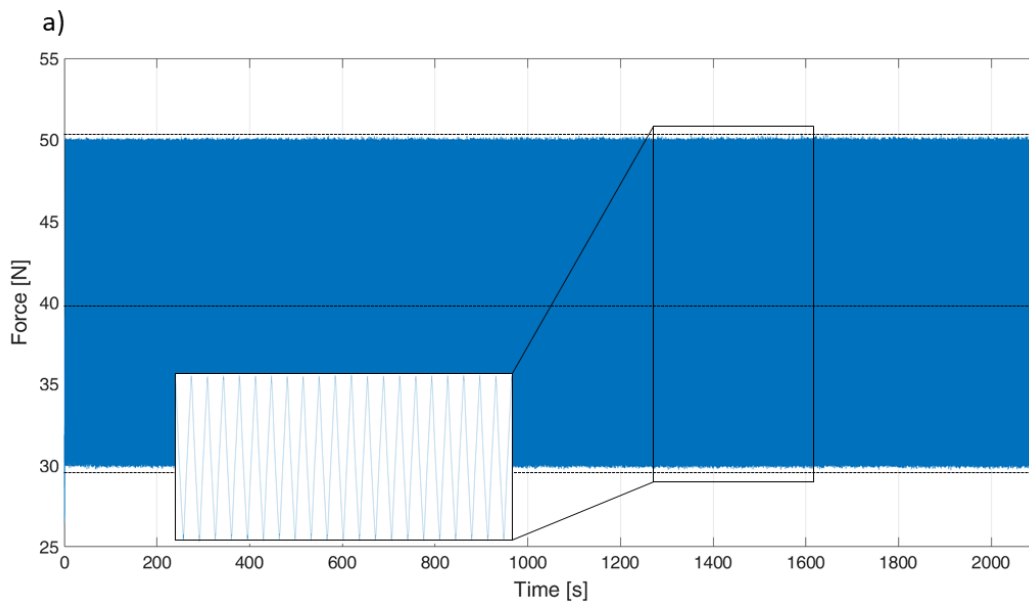

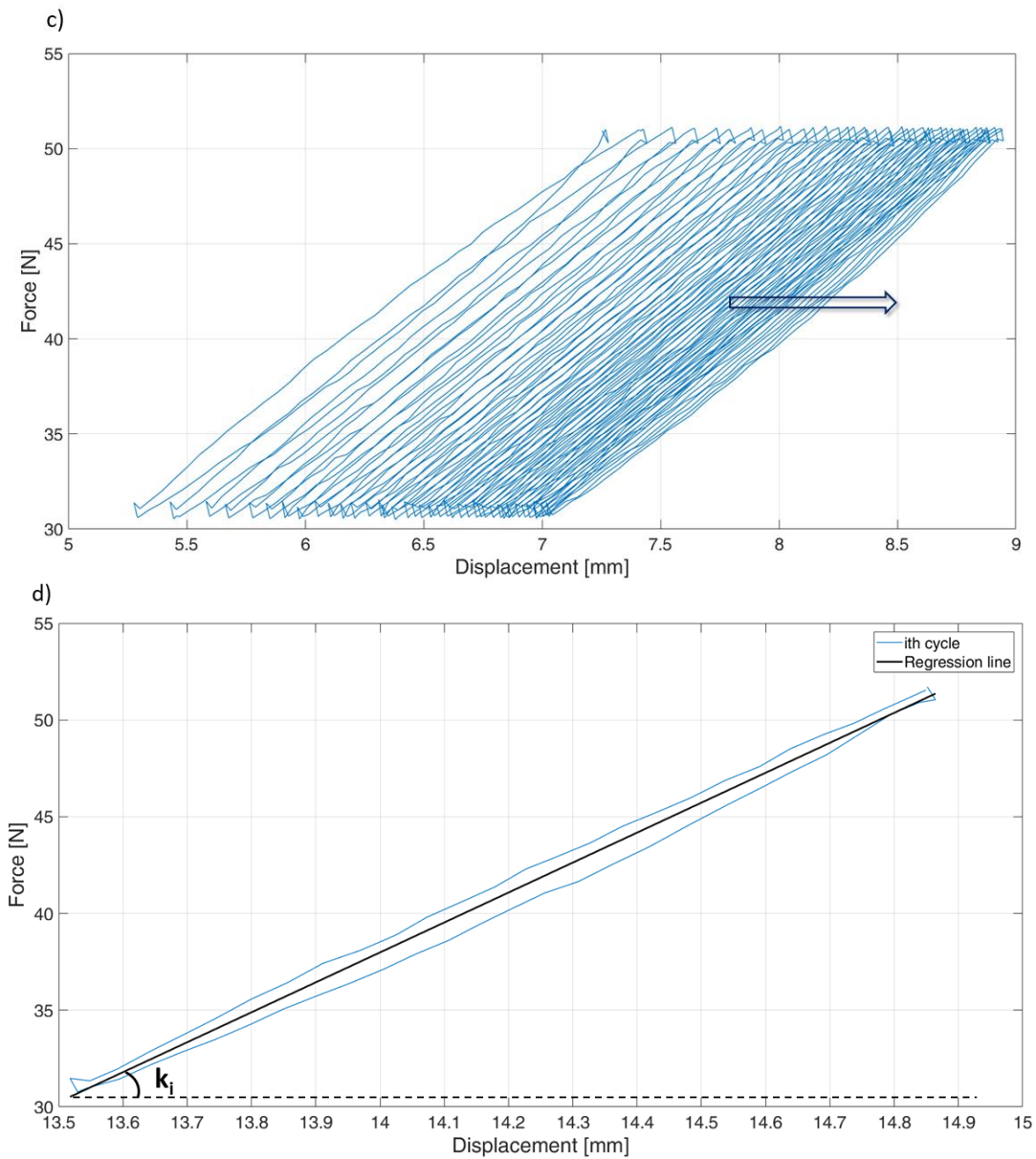

Figure 6. Cyclic loads: Force vs time for the full test (a); Displacement vs time for the full test (b); Force vs Displacement cycles (c); Analysis of one single cycle (d)

With reference to tensile tests, the curve might not be monotonous, like the one here reported (Figure 7). Referring to tests performed in this work, this has happened whenever one of suture anchorage points had partially failed and had migrated up to another stable point, or when the thread was spoiled during ex-vivo surgery, therefore it was partially torn during tensile tests. The visual analysis of specimens after testing allowed to establish the cause of local peaks in tensile test curves.

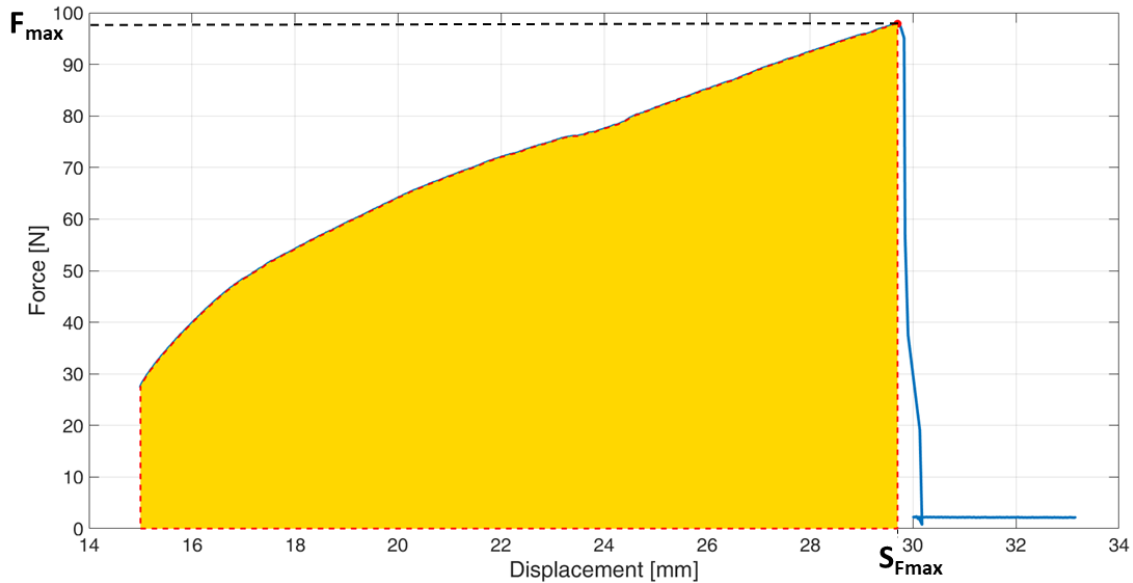

Figure 7. Tensile Tests

With reference to tensile tests, the following parameters can be assessed:

- $F_{max}$  that is the maximum force withstood by the organ-suture system (about 100 N in Figure 7);
- $S_{Fmax}$  that is the displacement value in correspondence of the maximum force value (about 30 mm in Figure 7)
- $E$  that is the total energy required to rupture (the orange area under the curve in Figure 7).

With reference to the eight specimens here analysed as a benchmark, main results are reported in Table 1.

Table 1. Preliminary results from eight laryngoplasties and suture thread

		Cyclic Tests			Tensile Tests		
		D [mm]	$k_{ave}$ [N/mm]	S [mm/s]	$F_{max}$ [N]	$S_{max}$ [mm]	E [mJ]
<b>Larynx-Suture System</b>	Average	9.4	16.2	$2.9 \times 10^{-3}$	86.9	29.5	955
	Standard Deviation	2.9	3.3	$2.0 \times 10^{-3}$	22.0	7.3	573
	Standard Error [%]	11.3	6.3	25.9	8.1	8.1	16.7
<b>Suture</b>	Average	1.3	21.7	$4.4 \times 10^{-4}$	247*	-	-

\*[24]

These results prove that there is a significant distraction (about 9 mm) as a consequence of 3000 loading cycles, and a good repeatability concerning the mechanical behaviour of the whole organ-suture complex, with the exception of the strain rate: if the average of eight samples is considered, the standard error (s.e.) is equal to 11.3% for the total distraction, while it is lower than 7% for the average stiffness.

With reference to tensile tests, the ultimate load is not too far from peak loads reached during physiological actions (swallowing in this specific case); such a finding would suggest the need to design and develop new surgical techniques and suture threads. Both peak load and distraction

have good repeatability (s.e.<10%). On the contrary, data concerning energy absorption up to rupture are quite dispersed, and as such, they are likely to have limited significance. Age-related changes in elasticity of cartilages and mineralization are likely to play a role on the last behaviour [25], considered that specimens came from animals whose age ranged from 3 to 13 years.

Mid-suture failure took place in 25% cases; these failures happened at loads which are largely inferior to ultimate suture loads and were originated by suture wear; this aspect deserves to be deeply inquired since it leads to a reduced thread strength and it gives rise to the possibility of inflammatory tissue reaction to wear particles [26]. In the remaining 75% cases the failure occurred due to cut-through/fissure of the muscular process and this would suggest the need to design different suture fixation devices such as buttons or anchors [27,28].

According to Table 1, the behaviour of the only suture is significantly different from the behaviour of the organ-suture system. This aspect was clearly outlined by many authors studying the mechanical performance of sutured tendons and ligaments who uniaxially tested the whole sutured band [29]. One further step was considering both the soft tissue and its weakest anchorage point [30]. The next step has been here considered where both anchorage points needed to be taken into account due to the respective significant compliance and creep; this required setting up a complex loading device in order to allow not only on-site testing, but also stressing the suture with known loads.

More in detail, with reference to experimental results here obtained, the creep rate index of the suture alone is equal to about 15% the creep rate of the larynx-suture system (0.0030 mm/s); this means that the viscous behaviour of the suture is negligible if compared to the viscous properties of soft tissues. Therefore, S parameter reported in Table 1 is mostly due to soft tissues undergoing physiological loads.

The whole system (larynx-suture) can be approximated as a mechanical system made of the series of two springs: the larynx spring and the suture spring.  $k_{ave}$  parameter reported in Table 1 is the equivalent stiffness of the system which can be so calculated:

$$\frac{1}{k_{ave}} = \frac{1}{k_L} + \frac{1}{k_S} \quad (3)$$

Where:

- $k_L$  is the larynx stiffness
- $k_S$  is the suture stiffness.

Given Eq (3), the stiffness of the larynx  $k_L$  can be calculated as

$$k_L = \frac{k_{eq} \cdot k_S}{k_S - k_{eq}} \quad (4)$$

and it has resulted to be equal to 74.4 N/mm; this means that the major contribution to the system stiffness comes from the suture, which is more compliant than the larynx, and more specifically than the cartilages providing anchorage for the suture ends.

Referring to distraction (that is the total displacement produced by creep over 3000 cycles), it can be approximated as the sum of distractions of main system components:

$$D_{tot} = D_L + D_S \quad (5)$$

Where  $D_L$  and  $D_S$  represent, respectively, the larynx and the suture distraction. Therefore, the distraction of the larynx alone can be calculated as:

$$D_L = D_{tot} - D_S = 8.1 \text{ mm} \quad (6)$$

It is therefore possible to conclude that the larynx and its soft tissues play a major role with reference to creep behaviour.

Another widely used method in literature for on-site testing of sutures is ‘pinching’ the stitch, and applying a known force, as represented schematically in Figure 8. However, this way of operating is affected by one major bias.

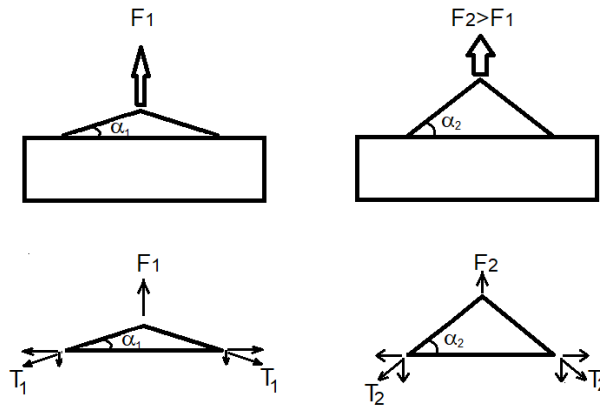

Figure 8. Widely used method to stress the suture

In fact, equilibrium equations applied to this loading system for two different force levels result in:

$$F_1 = 2T_1 \cos \alpha_1 \Rightarrow T_1 = \frac{F_1}{2 \cos \alpha_1} \quad (1)$$

$$F_2 = 2T_2 \cos \alpha_2 \Rightarrow T_2 = \frac{F_2}{2 \cos \alpha_2} \quad (2)$$

Where:

- $F_1, F_2$  are the applied forces (with  $F_2 > F_1$ )
- $T_1, T_2$  are thread tension, as a consequence of the application of forces  $F_1, F_2$  respectively
- $\alpha_1, \alpha_2$  are thread inclinations, as a consequence of the application of forces  $F_1, F_2$ , respectively.

This means that the thread tension does not depend on the applied force only, but also on the thread angle which can change significantly for different levels of the applied force; in other words, the thread tension, which is the key input variable in these tests, is actually undetermined, even if the applied force is controlled and therefore it is well known.

## 5. Conclusions

The authors have illustrated in detail a testing fixture used to study on-site tensile sutures performance with reference to repeated load cycles. This experimental set up has proved to provide good repeatability and therefore it will be used to compare different suture materials and different suture anchorages. The main advantage of this experimental set up is stressing the suture on-site and with a known load. As a result of experimental tests, it is possible to assess the total suture distraction following 3000 loading cycles, the asymptotic distraction rate, the average

stiffness of the organ-suture system. At the end, a static tensile test is performed in order to establish the ultimate force and displacement.

## 6. Declaration of Interest

The authors declare that they have no known competing financial interests or personal relationships that could have appeared to influence the work reported in this paper

## 7. Acknowledgements

This research was partially funded on the Project “Metodi di progettazione e verifica di dispositivi protesici e di sintesi ossea innovative”, fund “Ricerca di Base, 2018” by University of Perugia. The authors wish to thank Silvia Zanetti for her help in storing and managing organ samples.

## 8. References

- [1] S. Halepas, X.J. Chen, E.M. Ferneini, Thread-Lift Sutures: Anatomy, Technique, and Review of Current Literature, *J. Oral Maxillofac. Surg.* (2020). <https://doi.org/10.1016/j.joms.2019.11.011>.
- [2] M. Hess, D. Schroeder, K. Püschel, Sling arytenoid adduction, *Eur. Arch. Oto-Rhino-Laryngology*. 268 (2011) 1023–1028. <https://doi.org/10.1007/s00405-010-1429-2>.
- [3] V. Matievics, A. Bach, B. Sztano, Z. Bere, Z. Tobias, P.F. Castellanos, A.H. Mueller, L. Rovo, Functional outcomes of endoscopic arytenoid abduction lateropexy for unilateral vocal cord paralysis with dyspnea, *Eur. Arch. Oto-Rhino-Laryngology*. 274 (2017) 3703–3710. <https://doi.org/10.1007/s00405-017-4696-3>.
- [4] M. Bouazza, M. Elbelhadji, A. McHachi, L. Benhmidoune, A. Amraoui, Traitement du ptosis congénital par suspension au muscle frontal par fil de polypropylène: résultats d’une étude de 21 cas, *J. Fr. Ophtalmol.* 37 (2014) 520–525. <https://doi.org/10.1016/j.jfo.2014.01.014>.
- [5] R. Gazzola, E. Piozzi, L. Vaienti, F. Wilhelm Baruffaldi Preis, Therapeutic Algorithm for Congenital Ptosis Repair with Levator Resection and Frontalis Suspension: Results and Literature Review, *Semin. Ophthalmol.* 33 (2018) 454–460. <https://doi.org/10.1080/08820538.2017.1297840>.
- [6] T.E. David, C.M. David, M. Lafreniere-Roula, C. Manlhiot, Long-term outcomes of chordal replacement with expanded polytetrafluoroethylene sutures to repair mitral leaflet prolapse, *J. Thorac. Cardiovasc. Surg.* (2019). <https://doi.org/10.1016/j.jtcvs.2019.08.006>.
- [7] L. Pirtea, O. Balint, C. Secoşan, D. Grigoraş, R. Ilina, Laparoscopic Pectopexy with Burch Colposuspension for Pelvic Prolapse Associated with Stress Urinary Incontinence, *J. Minim. Invasive Gynecol.* (2019). <https://doi.org/10.1016/j.jmig.2019.10.022>.
- [8] J. Liu, J. Kohn, C. Wu, Z. Guan, X. Guan, Short-term Outcomes of Nonrobotic Single-incision Laparoscopic Sacrocolpopexy: A Surgical Technique, *J. Minim. Invasive Gynecol.* (2019). <https://doi.org/10.1016/j.jmig.2019.05.015>.
- [9] H.A. Gülbitti, B. Colebunders, A. Pirayesh, D. Bertossi, B. van der Lei, Thread-Lift Sutures: Still in the Lift? A Systematic Review of the Literature, *Plast. Reconstr. Surg.* 141 (2018) 341e–347e. <https://doi.org/10.1097/PRS.00000000000004101>.
- [10] L.X. Tong, E.A. Rieder, Thread-Lifts: A Double-Edged Suture? A Comprehensive Review of the Literature, *Dermatologic Surg.* 45 (2019) 931–940. <https://doi.org/10.1097/DSS.0000000000001921>.
- [11] H. de Bruijn, Y. Maeda, K.N. Tan, J.T. Jenkins, R.H. Kennedy, Long-term outcome of laparoscopic rectopexy for full-thickness rectal prolapse, *Tech. Coloproctol.* 23 (2019) 25–31. <https://doi.org/10.1007/s10151-018-1913-z>.
- [12] A. Adamiak-Godlewska, K. Skorupska, K. Romanek-Piva, J. Piłat, T. Rechberger, Additional secure circular suture during sphincteroplasty - preliminary results on the efficacy of fecal

- incontinence surgery in urogynecological patients, *Ginekol. Pol.* 90 (2019) 82–85. <https://doi.org/10.5603/GP.2019.0014>.
- [13] A. González-Barnadas, O. Camps-Font, D. Espanya-Grifoll, A. España-Tost, R. Figueiredo, E. Valmaseda-Castellón, In vitro tensile strength study on suturing technique and material, *J. Oral Implantol.* 43 (2017) 169–174. <https://doi.org/10.1563/aid-joi-D-16-00164>.
- [14] J.B. Rosenberg, J. Andersen, A. Barmettler, Types of materials for frontalis sling surgery for congenital ptosis, *Cochrane Database Syst. Rev.* 2019 (2019). <https://doi.org/10.1002/14651858.CD012725.pub2>.
- [15] V. Giri, S. Yadav, V. Tomar, A. Jha, A. Garg, Retrospective comparison of outcomes of laparoscopic pyeloplasty using barbed suture versus nonbarbed suture: A single-center experience, *Urol. Ann.* 11 (2019) 410–413. [https://doi.org/10.4103/UA.UA\\_123\\_15](https://doi.org/10.4103/UA.UA_123_15).
- [16] E. Kazum, O. Chechik, T. Pritsch, G. Mozes, G. Morag, O. Dolkart, E. Maman, Biomechanical evaluation of suture buttons versus cortical screws in the Latarjet–Bristow procedure: a fresh-frozen cadavers study, *Arch. Orthop. Trauma Surg.* 139 (2019) 1779–1783. <https://doi.org/10.1007/s00402-019-03269-6>.
- [17] O. Brandenberger, F. Rossignol, J.D. Perkins, A. Lechartier, C. Mespoulhès-Rivière, A. Vitte, A. Rossignol, N. Ducharme, K.J. Boening, Ex vivo biomechanical stability of 5 cricoid-suture constructs for equine laryngoplasty, *Vet. Surg.* 46 (2017) 705–713. <https://doi.org/10.1111/vsu.12671>.
- [18] P.M. Dixon, B.C. McGorum, D.I. Railton, C. Hawe, W.H. Tremaine, K. Dacre, J. McCann, Long-term survey of laryngoplasty and ventriculocordectomy in an older, mixed-breed population of 200 horses. Part 1: Maintenance of surgical arytenoid abduction and complications of surgery, *Equine Vet. J.* 35 (2010) 389–396. <https://doi.org/10.2746/042516403776014172>.
- [19] J. Schumacher, A.M. Wilson, C. Pardoe, J.L. Easter, In vitro evaluation of a novel prosthesis for laryngoplasty of horses with recurrent laryngeal neuropathy, *Equine Vet. J.* 32 (2000) 43–46. <https://doi.org/10.2746/042516400777611991>.
- [20] B.J. Ahern, R.C. Boston, E.J. Parente, In Vitro Mechanical Testing of an Alternate Laryngoplasty System(ALPS) for Horses, *Vet. Surg.* 41 (2012) 918–923. <https://doi.org/10.1111/j.1532-950X.2012.01061.x>.
- [21] T.H. Witte, J. Cheetham, L. V. Soderholm, L.M. Mitchell, N.G. Ducharme, Equine Laryngoplasty Sutures Undergo Increased Loading During Coughing and Swallowing, *Vet. Surg.* 39 (2010) 949–956. <https://doi.org/10.1111/j.1532-950X.2010.00742.x>.
- [22] F. Rossignol, R. Perrin, F. Desbrosse, C. Elie, In vitro comparison of two techniques for suture prosthesis placement in the muscular process of the equine arytenoid cartilage, *Vet. Surg.* 35 (2006) 49–54. <https://doi.org/10.1111/j.1532-950X.2005.00111.x>.
- [23] A. Lechartier, F. Rossignol, O. Brandenberger, A. Vitte, C. Mespoulhès-Rivière, A. Rossignol, K.J. Boening, Mechanical Comparison of 3 Anchoring Techniques in the Muscular Process for Laryngoplasty in the Equine Larynx, *Vet. Surg.* 44 (2015) 333–340. <https://doi.org/10.1111/j.1532-950X.2014.12248.x>.
- [24] S. Najibi, R. Banglmeier, J. Matta, M. Tannast, Material properties of common suture materials in orthopaedic surgery., *Iowa Orthop. J.* 30 (2010) 84–88.
- [25] H.M. Garvin, Ossification of laryngeal structures as indicators of age, *J. Forensic Sci.* 53 (2008) 1023–1027. <https://doi.org/10.1111/j.1556-4029.2008.00793.x>.
- [26] V. Lovric, M.J. Goldberg, P.R. Heuberger, R.A. Oliver, D. Stone, B. Laky, R.S. Page, W.R. Walsh, Suture wear particles cause a significant inflammatory response in a murine synovial airpouch model, *J. Orthop. Surg. Res.* 13 (2018) 311. <https://doi.org/10.1186/s13018-018-1026-4>.
- [27] W. V. McCallister, H.C. Ambrose, L.I. Katolik, T.E. Trumble, Comparison of pullout button

versus suture anchor for zone I flexor tendon repair, *J. Hand Surg. Am.* 31 (2006) 246–251. <https://doi.org/10.1016/j.jhsa.2005.10.020>.

- [28] S. Subotic, J. Rassweiler, Experimental evaluation of suture support in bladder-neck suspension for the treatment of female stress urinary incontinence, *J. Endourol.* 21 (2007) 931–938. <https://doi.org/10.1089/end.2005.9934>.
- [29] A. Blythe, T. Tasker, P. Zioupos, ACL graft constructs: In-vitro fatigue testing highlights the occurrence of irrecoverable lengthening and the need for adequate (pre)conditioning to avert the recurrence of knee instability., *Technol. Health Care.* 14 (2006) 335–47.
- [30] R. Attal, R. Mayr, C. Heinrichs, M. Eichinger, W. Schmoelz, Biomechanical Comparison of 2 Anterior Cruciate Ligament Graft Preparation Techniques for Tibial Fixation: Response, *Am. J. Sports Med.* 43 (2015) NP37–NP39. <https://doi.org/10.1177/0363546515601386>.