

Virtual Measurement of the Backlash Gap in Industrial Manipulators

Original

Virtual Measurement of the Backlash Gap in Industrial Manipulators / Giovannitti, E., Squillero, G., Alberto, T.. - ELETTRONICO. - 1092:(2020), pp. 189-200. (SEMCCO 2019 & FANCCO 2019 Maribor, Slovenia,EU 10 – 12 July 2019) [10.1007/978-3-030-37838-7_17].

Availability:

This version is available at: 11583/2748934 since: 2020-02-14T16:45:03Z

Publisher:

springer

Published

DOI:10.1007/978-3-030-37838-7_17

Terms of use:

This article is made available under terms and conditions as specified in the corresponding bibliographic description in the repository

Publisher copyright

Springer postprint/Author's Accepted Manuscript

This version of the article has been accepted for publication, after peer review (when applicable) and is subject to Springer Nature's AM terms of use, but is not the Version of Record and does not reflect post-acceptance improvements, or any corrections. The Version of Record is available online at: http://dx.doi.org/10.1007/978-3-030-37838-7_17

(Article begins on next page)

Virtual Measurement of the Backlash Gap in Industrial Manipulators

Eliana Giovannitti¹[0000-0001-5180-6651], Giovanni Squillero²[0000-0001-5784-6435], and Alberto Tonda^{3,4}[0000-0001-5895-4809]

¹ Politecnico di Torino, Torino, Italy
`eliana.giovannitti@polito.it`

² Politecnico di Torino, Torino, Italy
`squillero@polito.it`

³ Université Paris-Saclay, Saclay, France

⁴ UMR 782 INRA, Thiverval-Grignon, France
`alberto.tonda@inra.fr`

Abstract. Industrial manipulators are robots used to replace humans in dangerous or repetitive tasks. Also, these devices are often used for applications where high precision and accuracy is required. The increase of backlash caused by wear, that is, the increase of the amount by which teeth space exceeds the thickness of gear teeth, might be a significant problem, that could lead to impaired performances or even abrupt failures. However, maintenance is difficult to schedule because backlash cannot be directly measured and its effects only appear in closed loops. This paper proposes a novel technique, based on an Evolutionary Algorithm, to estimate the increase of backlash in a robot joint transmission. The peculiarity of this method is that it only requires measurements from the motor encoder. Experimental evaluation on a real-world test case demonstrates the effectiveness of the approach.

Keywords: Evolutionary Computation; Backlash; Robotic joint transmission; Shaft variable stiffness

1 Introduction

In an industrial context it is of paramount importance to guarantee correct and continuous operation of machinery, as in complex production lines — consisting of hundreds of devices — any abrupt stop may lead to significant economic losses. To this regard, *industrial manipulators*, the robots used to replace humans in dangerous or repetitive tasks, are particularly critical: an extremely high precision and accuracy is usually required, while gears are inevitably subjected to mechanical deterioration.

The *backlash* is the rotational arc clearance between a pair of mating gear teeth, that is, the amount by which a tooth space exceeds the thickness of a gear tooth engaged in mesh. While a small amount of backlash is intentionally designed to ensure smooth movements, the increase of the gear play due to

wear may cause important nonlinearities and eventually limit the performance of speed controllers, possibly causing even a permanent damage to the apparatuses.

With industrial manipulators, an estimate of the backlash gap is useful to foresee possible criticalities and perform the maintenance before a malfunctioning or a breakdown. Unfortunately in most robots the backlash appears in closed loop and typically there is access only to the final motor speed [3].

This paper addresses the problem of estimating the increase of the backlash in a robot joint transmission relying only on measures on the motor encoder and estimates based on models and Evolutionary algorithms.

The paper is organized as follows. In Section 2 the problem of the backlash in a mechanical transmission and the evolutionary algorithm on which its estimation is based are introduced. Section 3 describes the mechanical system under examination, its Matlab/Simulink model that allowed the analysis of the backlash phenomenon and its effect on the motor speed signal. Finally the set-up for the genetic algorithm used for the backlash estimation is exposed. In Section 5 the results of the proposed method, applied to the case of two speed signals measured on the real mechanical system, are presented.

2 Background

2.1 Backlash

Gears are used to transmit torque from the motor to the load. In an ideal gear system the mating gear teeth are always in contact, perfectly transmitting movement from the motor to the load. In the presence of backlash the contact between two paired teeth is interrupted for a small angle and then it is re-established. This can cause impacts and vibrations on the moving parts and a lower positioning accuracy for the robot. Many backlash mathematical models are available in literature, the classical *dead zone model* and *hysteresis model* [4],[3] are among the most used ones.

The model we used in this work is presented in [5]. It is a modification of the *dead zone model* and has been integrated into the Simulink model of the mechanical system under test. The system is represented with the typical linear dynamic model used for a mechanical transmission: a two-mass system with an elastic coupling and backlash. The first mass represents the motor, with the moment of inertia J_m , that is coupled to the load, the second mass with moment of inertia J_l , by a shaft. The shaft is considered mass free and is modeled with a torsional stiffness spring K_s and a damping D_S . The backlash gap is δ .

When the mating gears are in contact the motor is connected to the load, the load torque τ_l is proportional to the angle difference $\Delta\theta$ and to the speed difference $\Delta\omega$, see Equation (1). When the gear travels the backlash gap the motor loses contact with the load and the load torque becomes zero, see Equation (2).

Defining

$$\Delta\theta = \frac{1}{N}\theta_m - \theta_l$$

Symbol	Description	Units
θ_m, θ_l	Motor/Load angular position	rad
ω_m, ω_l	Motor/Load angular velocity	rad
τ_m, τ_l	Motor/Load torque	Nm
J_m, J_l	Motor/Load inertia	Kgm^2
K_s	Shaft stiffness	Nm/rad
D_s	Shaft damping coefficient	Nm s/rad
δ	Backlash angle	rad
N	Gear ratio	-

Table 1: System parameters.

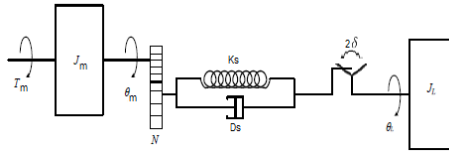

Fig. 1: Two mass system with elastic coupling and backlash.

$$\Delta\omega = \frac{1}{N}\omega_m - \omega_l$$

The interconnecting torque τ_l is

$$\tau_l = K_s\Delta\theta + D_s\Delta\omega \quad (1)$$

and in presence of backlash Equation (1) becomes

$$\tau_l = \begin{cases} K_s(\Delta\theta - \delta \cdot \text{sign}(\Delta\theta)) + D_s\Delta\omega & |\Delta\theta| > \delta \\ 0 & |\Delta\theta| \leq \delta \end{cases} \quad (2)$$

2.2 Covariance Matrix Adaptation Evolution Strategy

Covariance Matrix Adaptation Evolution Strategy (CMA-ES) is a stochastic optimization technique belonging to the family of Evolutionary Algorithms (EAs). EAs [1] are loosely inspired by the neo-Darwinian paradigm of natural selection, and are able to efficiently explore large and irregular search spaces. As they are stochastic, there is no guarantee that they will find any global optimum, but in several complex real-world problems they proved able to deliver solutions of high quality in a reasonable amount of time, and nowadays are applied to problems in which traditional optimization techniques fail [7].

EAs also belong to the family of *local search algorithms*: they starts by generating random candidate solutions to the problem, and their capability to solve the problem at hand is measured by a *fitness function*. In successive iterations, good candidate solutions are more likely to be selected to *reproduce*, generating new candidate solutions that are similar to the originals. The process is repeated until a solution of satisfying quality is found, or until a user-specified stop condition is reached.

The field of evolutionary computation can be further divided into categories of algorithms, such as Genetic Algorithms (GAs) or Genetic Programming (GP) – a reminiscent of their origin. Among such algorithms, *Evolution Strategies* (ES) [6, 8] soon emerged as a quite powerful tool for optimizing problems with real-valued variables. CMA-ES [2] is the most effective extension of the original algorithm available nowadays. In CMA-ES, the adaptation of the covariance matrix amounts to learning a second order model of the underlying objective

function similar to the approximation of the inverse Hessian matrix in the Quasi-Newton method in classical optimization. In contrast to most classical methods, fewer assumptions on the nature of the underlying objective function are made. Only the ranking between candidate solutions is exploited for learning the sample distribution and neither derivatives nor even the function values themselves are required by the method.

3 Proposed Approach

The proposed approach is composed of five independent steps:

- The backlash phenomenon is evaluated from a theoretical perspective. A simulation model is built to assess its effect on the measured speed.
- The disturbance pattern is represented as an analytic expression with a set of parameters.
- The disturbance pattern at increasing backlash values is generated by simulation, and a relationship between the relevant parameters and the actual backlash value is determined.
- The real speed signal is recorded. The parameters of the disturbance pattern are evaluated by fitting the theoretical disturbance on the measured data by an EA.
- The estimated parameters are eventually used to assess the backlash value affecting the real system.

A common approach to the backlash analysis of a mechanical transmission is the use of an output (i.e. on the load side) encoder or a torque sensor. These devices allow a direct measure of the quantities of interest. The present method instead only relies on the encoder provided on motor side which is the standard equipment for an industrial robot. The amount of backlash is estimated by using the motor speed signal. By defining proper working and stress conditions it is possible to detect the presence of a disturbance signal superimposed on the speed signal. The disturbance has a known aspect and can be related to the backlash phenomenon. The disturbance waveform has been identified, isolated and validated by a test campaign on the test bench that reproduces the real transmission of an industrial manipulator joint.

4 Experimental Setup

A Matlab/Simulink model of the entire system was created, containing a mathematical model of the backlash phenomenon. Through this model it was investigated how the disturbance evolves as the backlash increases. Furthermore, the relationship that links the intensity of the disturbance to the value of the backlash gap was identified. Taking advantage of this relationship, it was possible to estimate the backlash angle amplitude starting from the motor speed signal. The estimate is performed using an evolutionary algorithm (CMA-ES).

4.1 Test Bench

The system under test is a typical rotary joint of an industrial manipulator. It is composed of a motor, a transmission belt and a reducer with a backlash value exceeding the defined acceptable limits. A load consisting of a cast iron mass is connected to the system. The only accessible measures on the system are the motor position, provided by an encoder connected to the motor, and the current absorbed by the motor itself. The system has no additional sensors after the transmission to obtain a direct measurement of the backlash. The disturbance appears as an undesirable oscillation on the speed signal measured by the encoder.

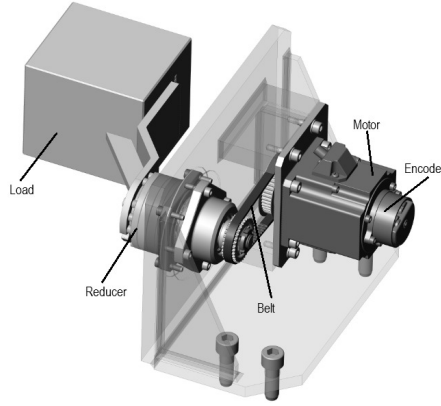

Fig. 2: Test Bench

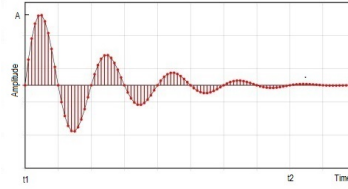

Fig. 3: Model of the disturbance signal induced by the backlash

The disturbance oscillations have the typical appearance of a percussive phenomenon in an elastic system with damping. Similarly to what happens when a hammer hits the string of a piano, the impact generates oscillations with an amplitude that decays exponentially with time.

For this reason it was decided to attribute the mathematical model described by the following formula to the disturbance:

$$d_b(t) = \begin{cases} 0 & t < t_1 \\ A e^{-(t-t_1)\tau} \sin \omega(t) & t_1 \leq t \leq t_2 \\ 0 & t > t_2 \end{cases} \quad (3)$$

where

- t_1 = the starting time of the oscillation
- A = the maximum amplitude of the oscillation
- τ = a damping factor
- t_2 = the ending time of the disturbance.

Tests were conducted by running the motor at a constant speed. Under these conditions the system is in a steady state in which the effects of disturbances such as static frictions and inertial phenomena are not present. In these circumstances the backlash phenomenon is highlighted due to small impacts caused by the action of gravity.

4.2 Matlab/Simulink Model

Once the working conditions and the input signal have been defined and the shape of the disturbance has been identified, a Matlab/Simulink model of the entire system was developed. The model used for the system is the one presented in Section 2.1 and is composed by: a motor with an encoder, a transmission, a load and a control loop with linear feedback from the measured motor speed/position. The transmission is affected by backlash and the gravity effect is considered through the load dynamics. The model is shown in Figure 4.

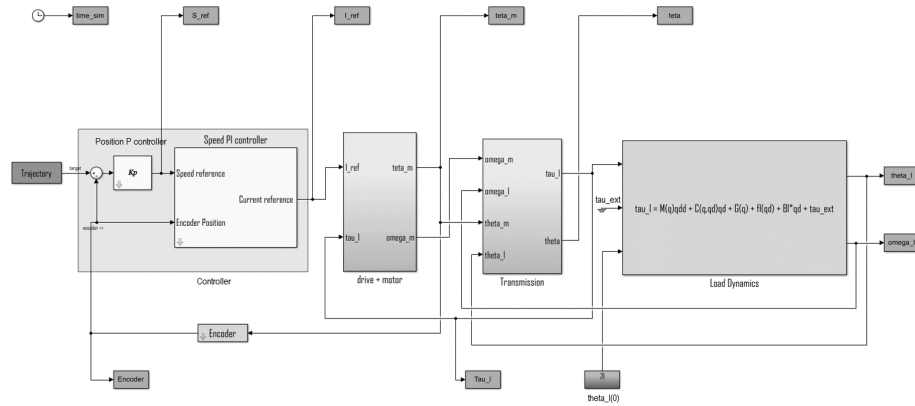

Fig. 4: Matlab/Simulink Model of the system

By leveraging the simulation flexibility it was possible to analyze different backlash conditions and to understand how the disturbance changes as the backlash increases. This helped to identify the relation between the intensity of the disturbance and the value of the backlash.

Many different backlash models have been proposed, the one used in this work belongs to the *deadzone type* and represents the backlash in terms of variable stiffness [5]. Outside the backlash zone τ_l is proportional to the angle difference between motor and load multiplied by the shaft stiffness. When the gear tooth travels the backlash zone the load disengages from the driving motor and the torque τ_l becomes zero.

The effect expressed by the Equation (2) can be also achieved through a variable shaft stiffness that becomes zero in the backlash zone:

$$K_{BL}(\Delta\theta, \delta) = \frac{K_s}{\pi} [\pi + \arctan(\alpha(\Delta\theta - \delta)) - \arctan(\alpha(\Delta\theta + \delta))]$$

$K_{BL}(\Delta\theta, \delta)$ is depicted in Figure 5.

The model employs the *arctan* function to avoid abrupt discontinuities. Acting on the α factor, a positive constant, it is possible to change the *arctan* slope. The load torque then becomes:

$$\tau_l = [\Delta\theta - \delta \cdot \text{sign}(\Delta\theta) + \frac{D_s}{K_s} \Delta\omega] \cdot K_{BL}(\Delta\theta, \delta)$$

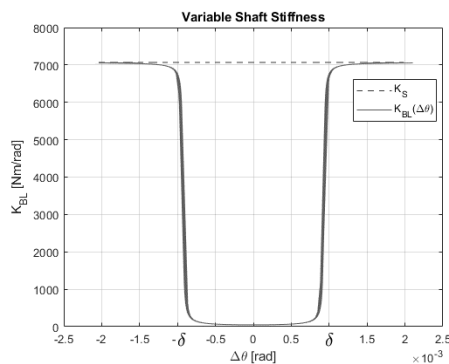

Fig. 5: Variable shaft stiffness. Stiffness value is K_S outside the deadzone, $|\Delta\theta| > \delta$, and then goes to zero when $|\Delta\theta| \leq \delta$

The model parameters used for the simulator setup were given by mechanical data and identification experiments.

To test the Simulink model we compared the simulation output with the measurements on the real system. Signals comparison is showed in Figure 6. The signals in light color are the position, the speed and the current of the motor measured on the test bench. The signals in the darker color are the position, the speed and the current of the motor obtained by the Simulink model. The figure shows that the simulator is able to correctly reproduce the real behaviour of the system with backlash.

Using simulation and varying the value of the backlash within an interval $\delta = [\delta_{min}, \delta_{max}]$ it was noted that the amplitude A of the oscillation of the disturbance signal (Equation (3)) is directly linked to the backlash amount δ . It was therefore possible to find a relationship between A and δ which allows to estimate the value of the backlash once the disturbance amplitude has been identified. Given the mechanical properties of our system a reasonable choice for the delta interval was $[0.0001, 0.0040]$ radians.

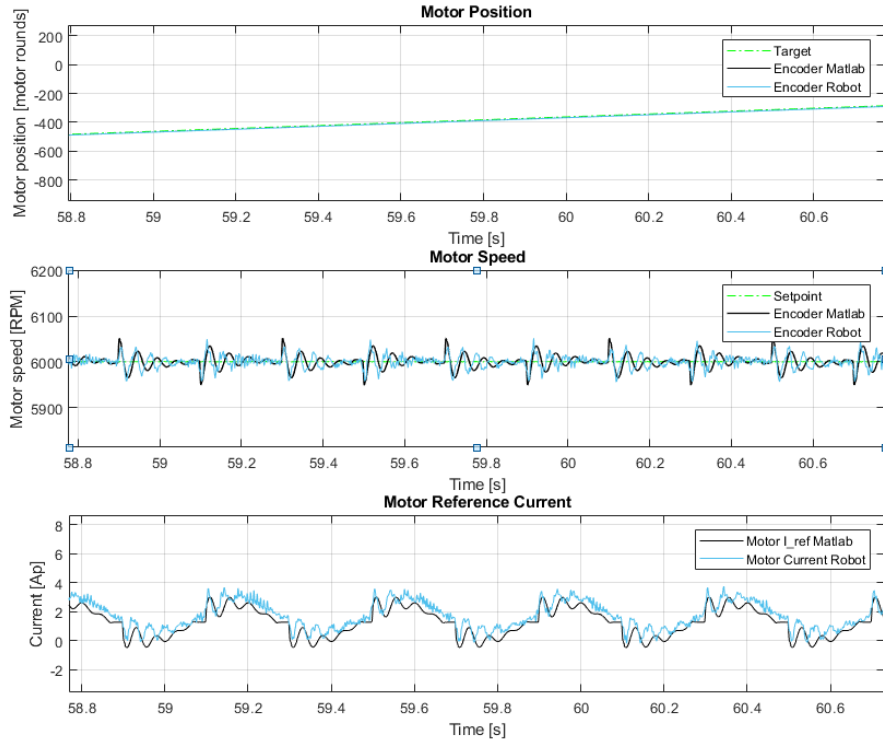

Fig. 6: Simulation Results with test bench signals superimposed.

The simulation results and the relation $A \mapsto \delta$ are showed in Figure 7 and Figure 8. The regression analysis results showed that the relation $\delta(A)$ is well described by by a cubic polynomial:

$$\delta(A) = 10^{-4} (-0.000009 A^3 + 0.003122 A^2 + 0.138764 A - 0.138809) \quad (4)$$

4.3 Backlash Identification

EA was used to recognize the backlash pattern in the motor speed signal. The identification relies on the minimization of the error between a measured signal and a generalization of the model defined in Equation (3). The *CMA-ES algorithm*, described in Section 2.2, was used for this activity. This tool is available on *GitHub*⁵ in a Python implementation.

⁵ <https://github.com/CMA-ES/pycma>

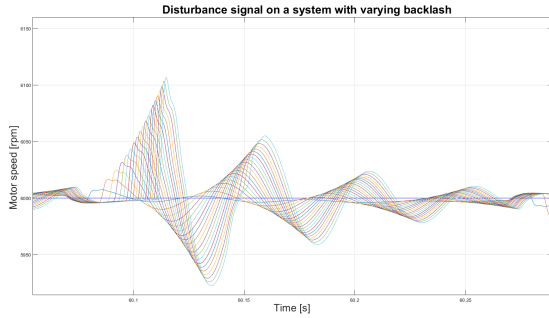

Fig. 7: Disturbance appearance at increasing backlash gap.

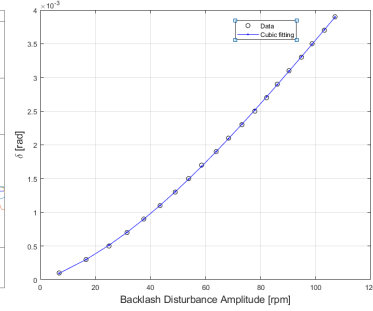

Fig. 8: Disturbance oscillation amplitude, A , and backlash gap value, δ , regression.

The main idea is to minimize the RMS error between the real signal $v(t)$ and the model we developed for the signal with backlash, Equation (6). We generalized the $d_b(t)$ model, see Equation (3), by defining a new function translated by a time offset t_0 :

$$g(t) = d_b(t - t_0) \quad (5)$$

Since gravity acts on the system as a torque on the motor that varies sinusoidally, the backlash causes a pulsed periodic disturbance. The time period corresponds to a 2π rad load rotation and contains two pulses having opposite signs. This effect is due to the link hitting the gear and the gear hitting the link at the beginning of respectively the descending and the ascending phases of the load movement. This led to the definition of the function

$$f(t) = g(t) - g(t + T)$$

Identification was performed on a sequence of 4 disturbance repetition in order to obtain mean values for the parameter identification. So the final model was

$$h(t) = v_t + \sum_{i=1}^4 f(t - i \cdot T_w)$$

where T_w is the time interval that corresponds to a full load rotation and v_t is the target motor speed.

The function relies on 7 unknown parameters and can be expressed as

$$h(t, A, t_0, \tau, \omega, v_t, t_1, t_2, T, T_w) = v_t + \sum_{i=1}^4 f(t, A, t_0 + i \cdot T_w, \tau, \omega, t_1, t_2, T) \quad (6)$$

The function to be minimized is then

$$RMSE = \sqrt{\frac{\sum_{i=1}^N (v(t) - h(t, A, t_0, \tau, \omega, v_t, t_1, t_2, T, T_w))^2}{N}}$$

For a fast algorithm convergence, it is critical to properly define the initial conditions for the parameters. We set up a procedure to compute the initial values based only on the measured signal $v(t)$ and a limited a priori system knowledge. The procedure starts by computing the variability range of each parameter (see Table 2) and then estimates the starting value for the mean x_0 and the variance σ_0 of each parameter as

$$x_0 = \frac{Max_value + Min_value}{2}$$

$$\sigma_0 = \frac{Max_value - Min_value}{4}$$

With these settings and using a population size of 3500 individuals the *CMA-ES algorithm* converges to a good solution (i.e. error = 0.14) in about 100 iterations.

Table 2: Parameters Variability Range

Symbol	Min_value	Max_value	Units
A	$-\frac{\max v(t) - \min v(t)}{2}$	$\frac{\max v(t) - \min v(t)}{2}$	rpm
t_0	$\min t$	$\max t$	s
τ	5	30	-
ω	2π	$2\pi \cdot 40$	rad/s
v_t	$\min v(t)$	$\max v(t)$	rpm
t_1	0	0.204	s
t_2	0	$\frac{0.204}{2}$	s
T	$\min t$	$\max t$	s
T_w	$\min t$	$\max t$	s

NOTE: t is the time vector of the measured signal v(t)

5 Experimental Results

Starting from two different datasets $v_1(t)$ and $v_2(t)$, acquired on the test bench and corresponding to two different and progressive situations of wear, it was possible to detect the increase in backlash gap through the use of CMA-ES. The algorithm was able to recognize the known disturbance pattern within the speed signal and to estimate the value of its parameters.

The two different identifications returned two increasing values for the oscillation amplitude A :

$$A_1 = 30.9033 [rpm], \quad A_2 = 39.2197 [rpm]$$

and, through the Formula (4), the corresponding backlash values:

$$\delta_1 = 6.8539e - 04 [rad], \delta_2 = 9.5394e - 04 [rad].$$

The results are shown in Figure 9 and in Figure 10.

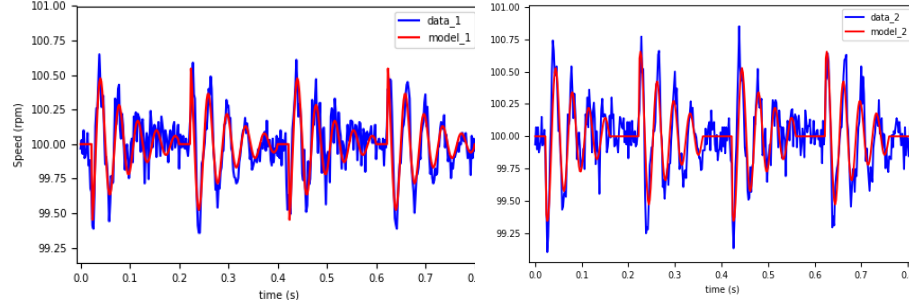

Fig. 9: CMA_ES identification results for dataset_1 (on the left side) and dataset_2 (on the right side). The signals acquired on the test bench are plotted in blue color; red plots are used for the model reconstruction relying on the parameters identified with CMA_ES.

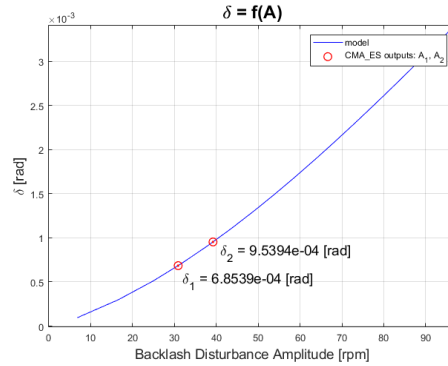

Fig. 10: Final backlash evaluation.

Figure 9 illustrates how, for both datasets, CMA_ES was able to obtain an average value of the model parameters, allowing to correctly approximate the starting signal, even if affected by a high noise. Moreover, Figure 10 shows that the algorithm is able to detect changes in parameter A with sufficient sensitivity to characterize changes in the backlash gap over time. The two datasets, in fact,

were obtained from the test bench at a distance of about 4 months during a continuous operation cycle of the device.

6 Conclusions and Future Works

A method for estimating the backlash in a mechanical transmission of a robot joint has been presented. The strategy used was explained and the results demonstrate the effectiveness of the proposed method. The result of the estimation can be used to implement strategies to compensate for the disturbance deriving from the backlash or to diagnose the operation of the robotic manipulator. The estimation of the parameters was performed using a state-of-the-art stochastic optimization technique, the CMA-ES.

The next step will be to embed a small device on each manipulator, able to record data and either transmit them to a centralized server or to process them in-situ. The required computational power is limited, as the CMA-ES may fit the disturbance parameters starting from a previously found solution.

References

1. De Jong, K.A.: Evolutionary computation: a unified approach. MIT press (2006)
2. Hansen, N., Ostermeier, A.: Completely derandomized self-adaptation in evolution strategies. *Evolutionary computation* **9**(2), 159–195 (2001)
3. Nordin, M., Bodin, P., Gutman, P.O.: New models and identification methods for backlash and gear play. In: *Adaptive Control of Nonsmooth Dynamic Systems*, pp. 1–30. Springer London (2001)
4. Nordin, M., Gutman, P.O.: Controlling mechanical systems with backlash a survey. *Automatica* p. 1633–1649 (2002)
5. Papageorgiou, D., Blanke, M., Niemann, H.H., Richter, J.H.: Backlash estimation for industrial drive-train systems. *IFAC-PapersOnLine* **50**(1), 3281–3286 (2017)
6. Rechenberg, I.: Evolutionsstrategien. In: *Simulationsmethoden in der Medizin und Biologie*, pp. 83–114. Springer (1978)
7. Sanchez, E., Squillero, G., Tonda, A.: *Industrial Applications of Evolutionary Algorithms*. Springer Berlin Heidelberg (2012)
8. Schwefel, H.P.: *Numerische Optimierung von Computer-Modellen mittels der Evolutionsstrategie*. (Teil 1, Kap. 1-5). Birkhäuser (1977)